

ALBIN 25 with Volvo Penta MD2B engine

(replacing fig. 6, 27, 28 and the engine chapter, p. 10—15, in the ALBIN 25 handbook).

The fuel consumption of the ALBIN 25 equipped with the MD2B engine is shown in fig. 1. The speeds are for calm weather without any sea.

ENGINE INSTALLATION (see fig. 2)

Technical data (additional engine data can be found in the instruction book for the VOLVO PENTA MD2B engine).

Engine, VOLVO PENTA 4-stroke diesel type MD2B with single lever teleflex control of engine revs and gearbox.

| | |
|---|---------------|
| Maximum revs | 2400—2500 rpm |
| Engine power at maximum rpm about | 25 h.p. |
| Cruising rpm about | 2000 rpm |
| Idling speed about | 600 rpm |
| Fuel consumption at cruising rpm | 3,0 l/h |

| | |
|--|------------|
| Oil quantity when changing to new oil, engine, about | 3 litres |
| Oil quantity when changing to new oil, reverse gear. | 0,5 litres |

| | |
|--|------------------------|
| | 0,11 Imp. gal. |
| | 0,12 US. gal. |
| Oil quality | Service DS |
| Oil viscosity (above +20°C) | SAE 20 |
| Oil viscosity (below +20°C) | SAE 10W |
| Oil pressure (with warm engine) full speed | 2—3 kp/cm ² |
| | 28—43 p.s.i. |

| | |
|-----------------------------|------------------------|
| Oil pressure, minimum | 0,8 kp/cm ² |
| | 14 p.s.i. |

| | |
|--|----------------|
| Cooling water temperature | 70—85°C |
| Direction of engine rotation (looking forward) | anti-clockwise |
| Reduction rear ratio | 1,91:1 |

| | |
|--|-------|
| Propeller shaft — stainless acid proof steel with two inner sealing rings and a rubber mounted outer bearing of water lubricated fibre, shaft diameter | 30 mm |
|--|-------|

| | |
|---|----------------|
| Rotating direction of the propeller (looking forward) | anti-clockwise |
|---|----------------|

| | |
|----------------------------|----------|
| Propeller — 3-bladed | 16"×10½" |
|----------------------------|----------|

| | |
|-----------------------|----------|
| Battery voltage | 12 volts |
|-----------------------|----------|

| | |
|--|-----------|
| Starter generator: Generator max | 135 Watts |
| Starter motor output | 1 hp |

| | |
|------------------------------|-----------|
| Alternator output, max | 450 Watts |
|------------------------------|-----------|

| | |
|---------------------------------|----------|
| Starting battery capacity | 57—60 Ah |
|---------------------------------|----------|

| | |
|---------------------------------|----------|
| Lighting battery capacity | 57—60 Ah |
|---------------------------------|----------|

The MD2B engine has separate lubricating oil filling and dipstick for engine and reduction/reverse gear. See fig. 2—4.

Oil has to be changed every 50 hours running or once each season if the engine is used a shorter time during the season. The first oil change should be made after 20 hours running. Empty the used oil when the engine is warm with the help of the oil pump included with the tool kit. The pump tube is inserted through the dipstick hole. The oil strainer must be removed to allow the oil to be sucked out. The reduction/reverse gear oil is drained through the drain hole or is sucked up with the oil pump through the hole for the dipstick.

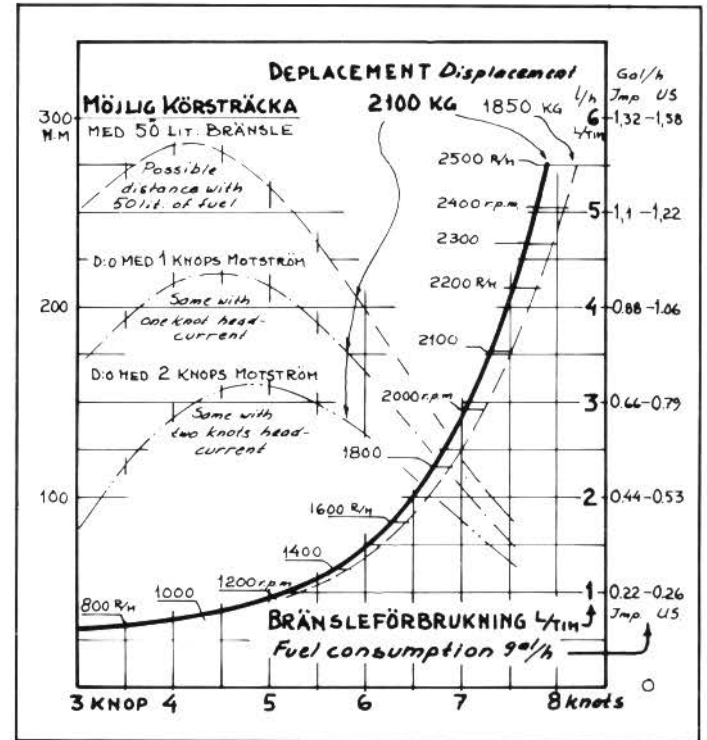

Fig. 1. Fuel consumption diagram

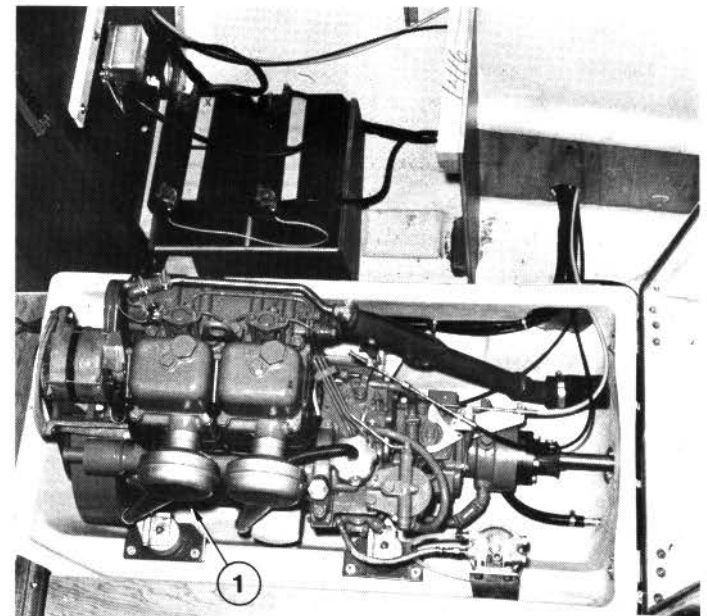

Fig. 2. Engine installation and batteries

1 Oil dipstick, engine

The engine oil filter should be changed after the first 20 hours running and then after every 100 hours running at the same time as the oil is changed.

The engine is cooled with sea water. The cooling water pump is an impeller type and the bearings are water lubricated. The working temperature of the engine is regulated by a thermostat. The right temperature is 70—85°C.

The reverse gear, type Mono Shift (MS), is combined with a reduction gear with ratio 1,91:1. Little force is required to operate the reverse gear.

MAINTENANCE OF THE ENGINE

Procedure before the first start

Before the engine is started the first time after launching the following precautions should be taken.

1. Remove the helmsmans seat. Remove the floorboards and the floor over the battery box (under the helmsmans seat). Unfasten the clasps on the engine cover and fold it aft (fig. 2).
2. Check the acid level in the batteries. The level should be about 10 mm above the plates. Fill with distilled water if the level is too low.
3. Check that the battery cables are connected.
4. The engine has been filled with lubricating oil at delivery. Recheck the oil level. It should be between the two marks on the dipstick not lower than the lower mark and not higher than the upper mark.
5. Check that the cooling water seacock is open (fig. 5).
6. When delivered, around 15 litres of fuel is put in the fuel tank. Before starting the tank ought to be filled with ordinary diesel oil, such as car diesel oil.
7. When the engine is tested before delivery the fuel system is bled free of air. It would be wise to do this again before the first start. It is important to know how to bleed the fuel system in case you happen to get air in the system while away cruising. This can happen if the fuel level is too low and the boat is rolling heavily. Try not to allow the fuel level to fall below 10 to 15 litres. The bleeding is performed as follows (fig. 3 and 4): The fuel is pumped using the hand primer. With long strokes at least 30 vertical movements will be necessary. Then open the vent screw on the fine filter. Continue pumping until fuel free from air bubbles flows out. Close the screw. Open the vent screw on the fuel injection pump. Now pump again until fuel free from air bubbles flows out. Close the vent screw.
8. Unscrew the plug on the propeller shaft oil pocket (fig. 5) and check that it is almost filled with grease. Fill with more grease if necessary. A soft outboard grease is most suitable. The grease is pressed directly from the tube until the oil pocket is almost full. Do not use high pressure. A grease gun must never be used as this may press out the forward sealing ring. Do not overfill the oil pocket as even screwing down the plug may exert enough pressure to push out the sealing ring.
9. Replace floorboards, engine cover and helmsmans seat. The engine is now ready for starting.

Starting

1. Check that the cooling water seacock is open.
2. Check that the stop control is pushed in (fig. 7).
3. Disengage the control lever with the disengaging latch (fig. 7) and move the control lever ahead to the starting position (position 7 in fig. 8).
4. Insert the starting key and turn it to position 1 in fig. 9.
5. Check that the yellow warning light for oil pressure and the red warning lights for charging are on.

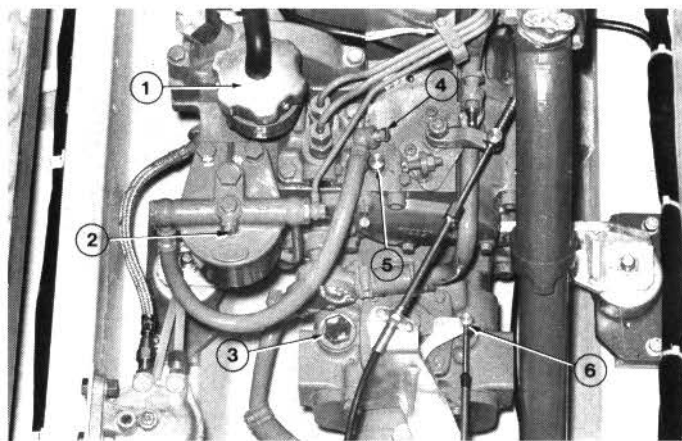

Fig. 3. Fuel vent screws and other details

- 1 Oil filler cap, engine
- 2 Vent screw, fine filter
- 3 Oil filler plug, reverse gear
- 4 Vent screw, injection pump
- 5 Cold starter button
- 6 Oil dipstick, reverse gear

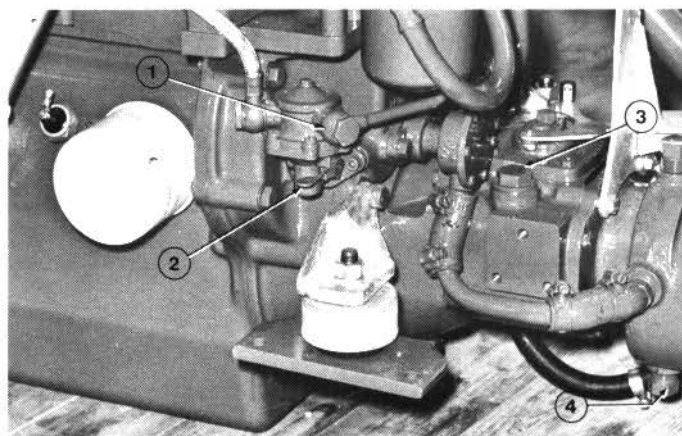

Fig. 4. Fuel feed pump

- 1 Fuel feed pump
- 2 Hand primer
- 3 Oil filler plug, reverse gear
- 4 Drain plug, reduction gear

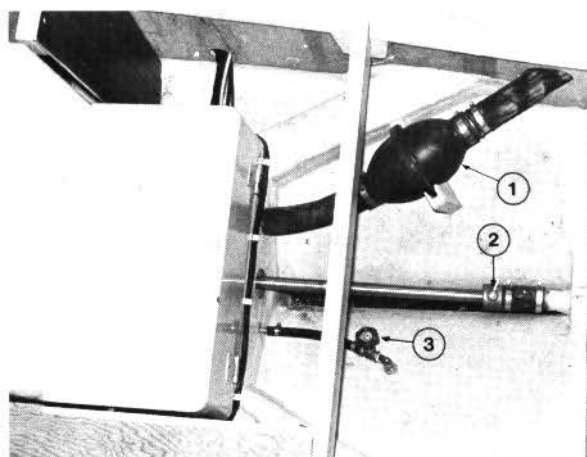

Fig. 5. Propeller shaft oil pocket and cooling water seacock

- 1 Silencer
- 2 Oil pocket
- 3 Cock, cooling water

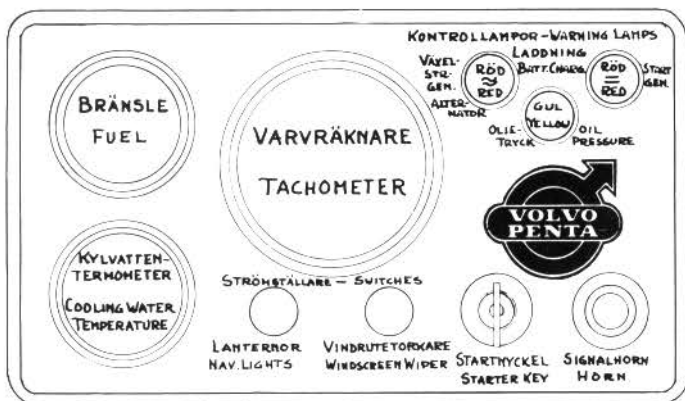

Fig. 6. Instrument panel

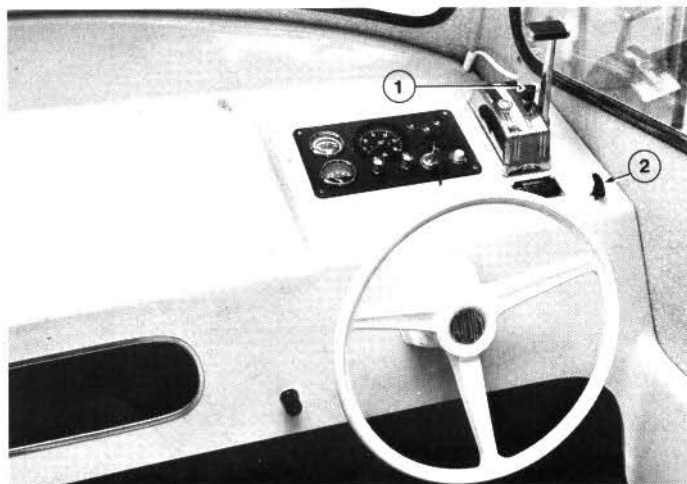

Fig. 7. Control position with instruments

- 1 Disengaging latch 2 Stop control

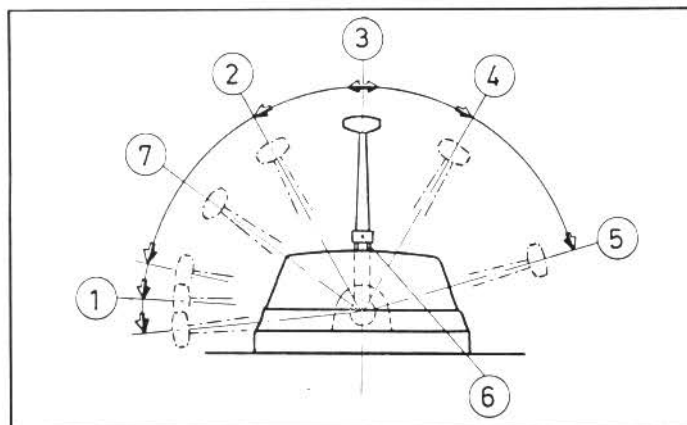

Fig. 8. Teleflex controls

- | | |
|-----------------------|------------------------|
| 1 "Ahead" — max speed | 5 "Astern" — max speed |
| 2 "Ahead" — idle | 6 Disengaging latch |
| 3 Neutral | 7 Starting position |
| 4 "Astern" — idle | |

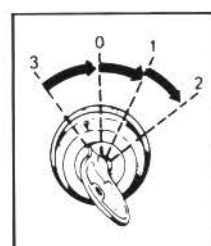

Fig. 9. Starter switch key

- 0 Neutral position
1 Switched-on position
2 Starter position (starter motor switched on)
3 "Radio" position

6. Push the starter switch key and turn clockwise to position 2 in fig. 9 (starter generator switched on). Hold the key there until the engine starts. The key when released will return to the switched on position (position 1 in fig. 9).
7. Move the control lever back to neutral when the engine is running evenly (position 3 in fig. 8).
8. Check that the yellow oil pressure warning light and red charging warning lights are out when the engine is running. The red light for the starter generator charging may twinkle or gleam dimly when the engine is idling.
9. Check that cooling water is discharged through the exhaust opening.

NOTE: The starter switch is also the main switch for the electrical system of the engine. Because the engine is equipped with an alternator the starter switch key must not be turned to off (position 0 in fig. 9) when the engine is running as electrical components may be damaged. For the same reason the battery cables should never be disconnected or reconnected to another battery while the engine is running.

NOTE: If the engine is difficult to start in cold weather the cold weather starting button on the fuel injection pump should be pushed in. This will supply a richer starting mixture. Set the control lever at the starting position (position 7, fig. 8) then push the cold weather starting button. It will remain in until it automatically releases when the engine starts. The position of the button is shown in fig. 3.

Manoeuvring

With the control lever in neutral (position 3, fig. 8) the propeller is not coupled to the engine and the engine is idling at about 600 rpm. Moving the lever forward to the distinct position 2 couples the propeller to the engine at idling speed. Moving the lever farther forward increases the engine speed. When the lever is moved backward to the distinct position 4 the propeller is coupled to the engine at idling speed. The propeller is now turning in a reverse direction. Moving the lever farther back increases engine speed.

The engine can be run at maximum rpm for long periods but 2000 rpm will give much more economical cruising.

Running

At regular intervals when running check:

- t h a t the cooling water temperature is 70—85°C;
- t h a t the warning lights for oil pressure or battery charging are not lit;
- t h a t enough fuel is available;
- t h a t the lubricating oil level is right. This should be done after the engine has been stopped for 5 minutes giving the oil time to run down to the oil sump;
- t h a t the acid level in the batteries is about $\frac{3}{8}$ inch above the top of the plates. If it is low add distilled water;
- t h a t no water has collected in the fuel line water separator. Any water should be drained off through the bottom screw.

Stopping

1. Place the control lever in neutral and allow the engine to idle some minutes before stopping it.
2. Pull out the stop control. As soon as the engine has stopped, push in the stop control again. Make it a habit, then you won't run the risk of using up unnecessary current next time you try to start with the knob.
3. Turn the starter switch key back from position one to the neutral position (position 0) and remove the key.

Prevention of frost damage

In spring and autumn when there is a risk of freezing temperature the following steps should be taken.

1. After stopping the engine close the seacock on the cooling water intake, fig. 5.
2. Open the cooling water draincocks on the engine block and exhaust — one draincock on each cylinder down on the starboard side and aft on the exhaust manifold. The cool jacket for the reduction gear is drained by the drain plug under the gear, see fig. 4.
3. When the water has drained, start the engine and run for one minute but no longer as the impeller pump can be damaged. During this minute the engine should be run for short bursts up to 1500 rpm. This will blow all water out of the exhaust system.

Precautions when engine is not used

In the case of an idle period of **less than a month** with the boat afloat, the engine should be started and run warm at least every 14 days to prevent corrosion damage to the internal parts of the engine.

If the engine is to remain idle for a **longer period than one month** the engine should be inhibited, see "Procedure before laying up".

Procedure before laying up

The complete procedure as described in the engine instruction book (p. 26—29) has to be performed to ensure the dependability and the life time of the engine. This is also a condition for the engine manufacturer's guarantee to be valid.

The following simplified procedure is a definite minimum requirement and is recommended to be used at a pinch and on the owner's own responsibility.

1. Add inhibiting oil such as Esso Rust Ban 623 to the fuel tank giving a fuel mix of about 33 %. If there is 5 litres of diesel fuel left in the tank put in 2.5 litres of inhibiting oil.
2. Run the engine at least half an hour (fast idling). The last 10 minutes the engine should be run with fresh water cooling (the cooling water tube to a bucket of water). While the engine is still warm the lubricating oil should be changed.
3. Clear the cooling system of water as described in the frost prevention paragraph. Loosen the hose clip on the exhaust line to the silencer and drain remaining water. Fasten again.
4. Start the engine and run if for one minute with a short race to higher r.p.m.
5. The batteries should be removed and stored fully charged in a place protected against frost.

Procedure before the first start next season

1. Replace the batteries, fully charged and checked.
2. Change oil and fuel filters. Check that there is no water in the fuel line water separator. Clean the feed pump pre-filter and the air cleaners.
3. Top up the fuel tank.
4. Bleed any air from the fuel system.
5. Check that the cooling water seacock is open and that the drain on the engine block and exhaust system are closed.
6. Put grease in the propeller shaft stuffing box, propeller and reversing mechanism.

Electrical system

The electrical system circuit diagram with engine MD2B is shown in fig. 10. Separate systems are used for engine and lighting. The starting battery is charged by the engine starter generator (Dynastart).

The lighting battery is charged by a separate alternator.

If the starting battery should be discharged the connecting cables can be moved to the lighting battery (if this is charged) to get starting current.

In other respects the directions in the handbook (p. 19) are valid, except that there is no time limit for idling without the propeller turning. However, charging the starting battery has to be done at higher revs than idling (more than 1000 r.p.m.). The alternator is charging the lighting battery at idling revs.

- 1 navigatör lampa skatelan
- 2 riktvisaren skatelan
- 3 start en skatelan slot
- 4 signallhorn druckknop-
- 5 = olie druck signall lampje
- 6 = startaccu " " Dynast.
- 7 = Verl. accu " " 4 Dijn
- 8 = toerental meter
- 9 = brandstof
- 10 = koelwater temp. meter

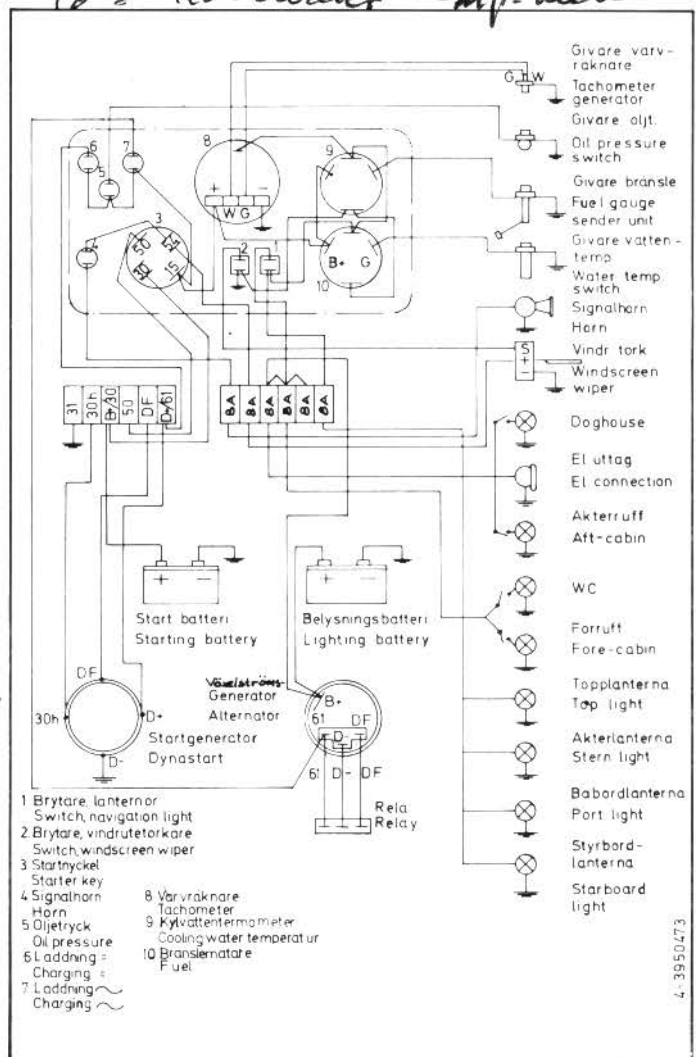

Fig. 10. Circuit diagram