

VISION 32

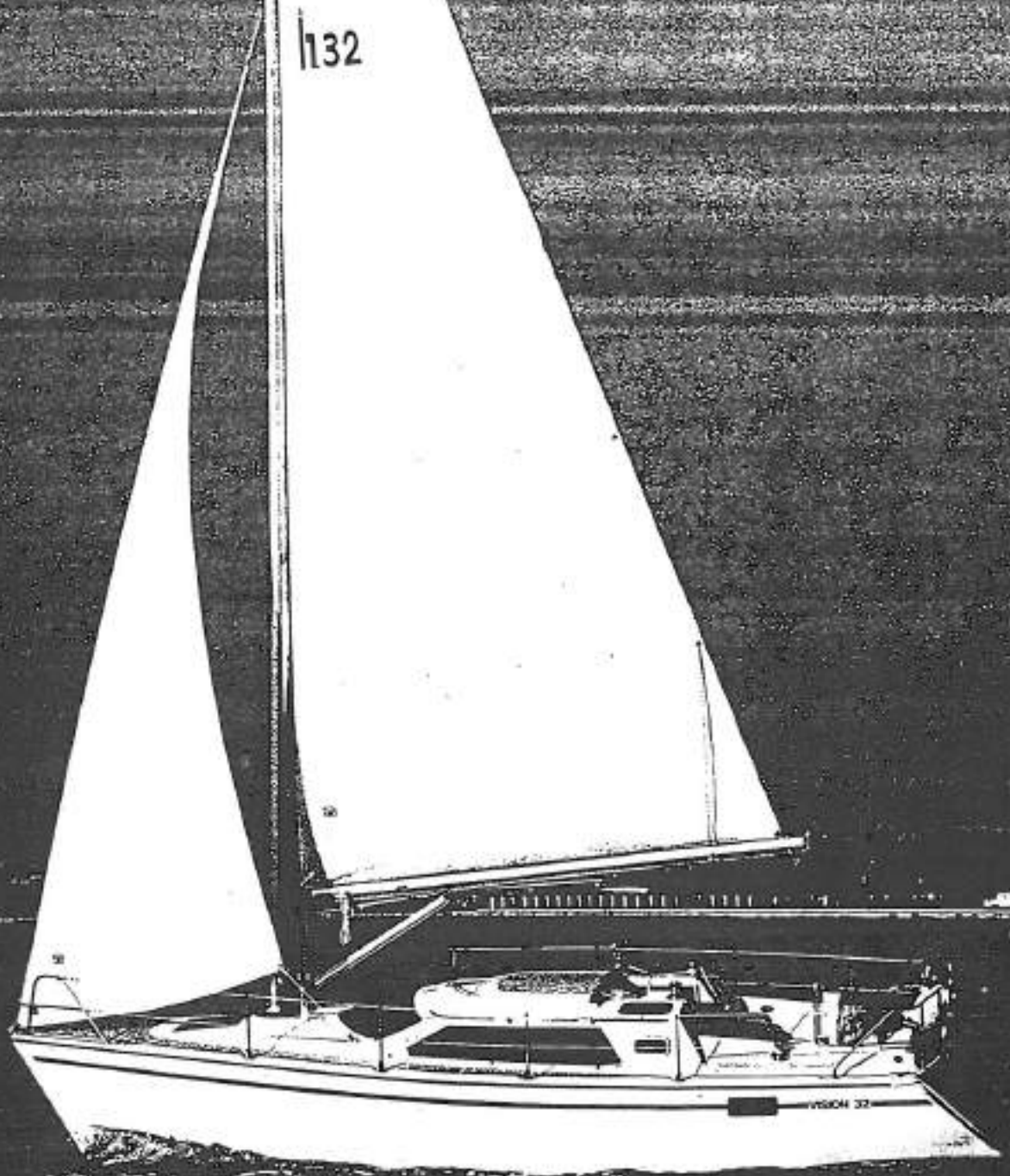

H U N T E R M A R I N E

SPECIFICATIONS

LOA.....	32'0"	9.75m
LWL.....	28'9"	8.76m
Beam.....	11'4"	3.45m
Draft (bulb-wing).....	4'3"	1.30m
Ballast.....	4500lbs	2045kg
Displacement.....	11,400lbs	5175kg
Sail Area (100% foretriangle).....	567 sq ft	52.7m ²
I.....	33'0"	10.06m
J.....	8'3"	2.51m
P.....	43'9"	13.34m
E.....	16'0"	4.88m
Mast Ht (fr dwl).....	53'0"	16.15m
Headroom.....	6'3"	1.9m

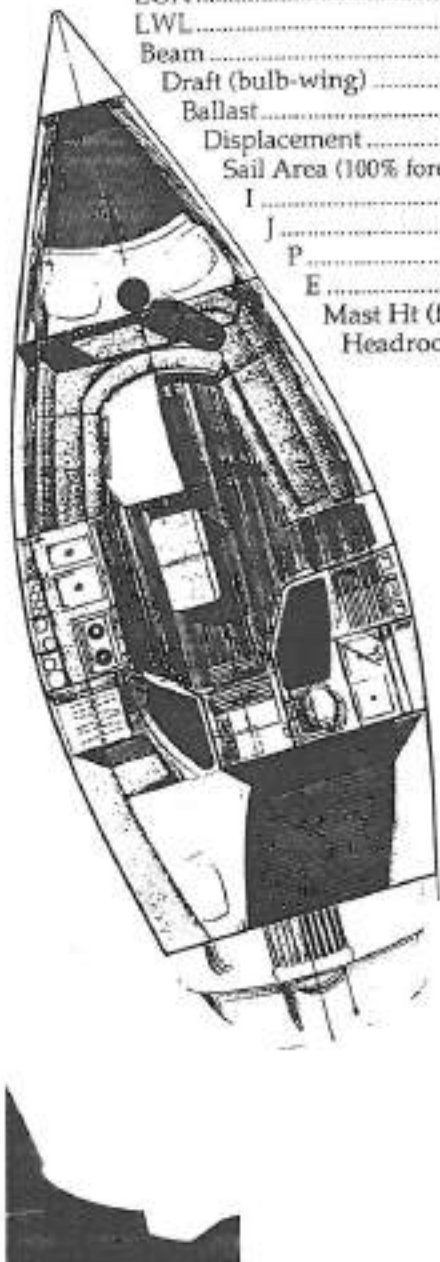

Bulb wing keel.



Head with shower.



Electric halyard winch.

HUNTER CUSTOMER'S "Bill of Rights"

Every person at Hunter Marine pledges 100 percent effort to provide you with:

- The best price and value available today.
- A safe, trouble-free boat for years of family enjoyment.
- A boat designed and built with innovation and premium materials.
- A company with the resources and experience to stand by its product, and its customers.
- A toll-free customer hotline so we can respond quickly to your needs and suggestions.
- A one-year limited warranty and five-year 100 percent bottom blister protection.

© Copyright 1989, Hunter Marine. All rights reserved.

CRUISE PAC[®]

While everyone else was complaining about the high cost of marine hardware and accessories, Hunter was doing something about it. The Hunter Cruise Pac[®] was developed to make all the accessories and hardware you need standard equipment. We buy top quality gear in very large quantities. The result? Equally large savings. The Vision 32 Cruise Pac[®] isn't just sails, winches, and running rigging - it's things like furling systems, cockpit showers, anchors, fire extinguishers, running lights, life jackets - even a copy of Chapman's *Piloting, Seamanship, and Small Boat Handling*. We invite you to compare the Standard Equipment list below with that of any other manufacturer. You'll discover that Hunter is going the distance for you with more - and better gear. For less.

RIGGING:

110% genoa w/UV suncover
Roller furling system
Full bottom mainsail with lazy jacks
Dual 130sqft led to cockpit
Main sail cover
(2) two-speed self-tailing genoa winches
Electric halyard winch
Self-tailing cabin-top winch
(2) quad sheet stoppers
Roller bearing main halyard sheaves
Internal halyards led to cockpit
Line adjustable staysheet traveler
Inboard genoa tracks with cars
Spun tapered, anodized aluminum, free standing mast with boom
Aluminum boom using
Windex wind vane

ELECTRONICS:

AM/FM stereo cassette with cabin and cockpit speakers

DECK:

Stainless steel bow and stern pulpits
Stainless steel swim ladder
Double lifelines with gates
Mooring cleats
On-deck anchor well with roller
Stainless steel recessed handrails
Wrap-around windshield with cover
Two-tone non-skid deck

COCKPIT:

Wheel steering with lighted compass, pedestal guard, and wheel brake
Modified T-shaped cockpit
Integrated swim platform
Transom shower
Removable helm seat
Wheel brake
Three cockpit lockers, plus two transom lockers

ELECTRICAL:

Dual 12V battery switch
Battery charger
Running lights with mast steaming lights and anchor light
Automatic bilge pump
Multiple AC outlets in cabin
Recessed cabin lights
Cabin reading lights

CABIN:

Sealed teak and holly sole
(5) opening ports
(3) opening hatches
Dinette table (convertible)
Hanging locker
Fully enclosed head with mirror and shower stall
(12 gal., 45l) holding tank
Nav station
Curtains
Private aft stowage cabin
Sleeping for six

GALLEY:

Double stainless sinks
Hot and cold pressure water system
Gimballed stove with oven
Corian[®] countertop
Icebox with Corian[®] countertop
Freshwater tank (50 gal., 190l)

AUXILIARY POWER:

27hp Yanmar diesel, freshwater cooled
Fuel tank (22 gal., 83l)

GENERAL SAFETY GROUP:

Anchor and line
Life jackets
Flags
Throwable device
Fog bell
Two fire extinguishers
Emergency tiller
Chapman's *Piloting, Seamanship and Small Boat Handling*

Hunter Marine reserves the right to modify or change, without notice, any materials, specifications, equipment and/or accessories. All measurements are approximate. Standard equipment may vary for product sold outside the United States.

HUNTER

HUNTER MARINE CORPORATION

Post Office Box 1030

Alachua, Florida 32615

Phone (904) 462-3077 • FAX (904) 462-4077

NATIONAL CUSTOMER HOTLINE

US: 1-800-771-5556; FL: 1-800-940-5556

CERTIFIED
NMEA

<https://www.boat-manuals.com/>

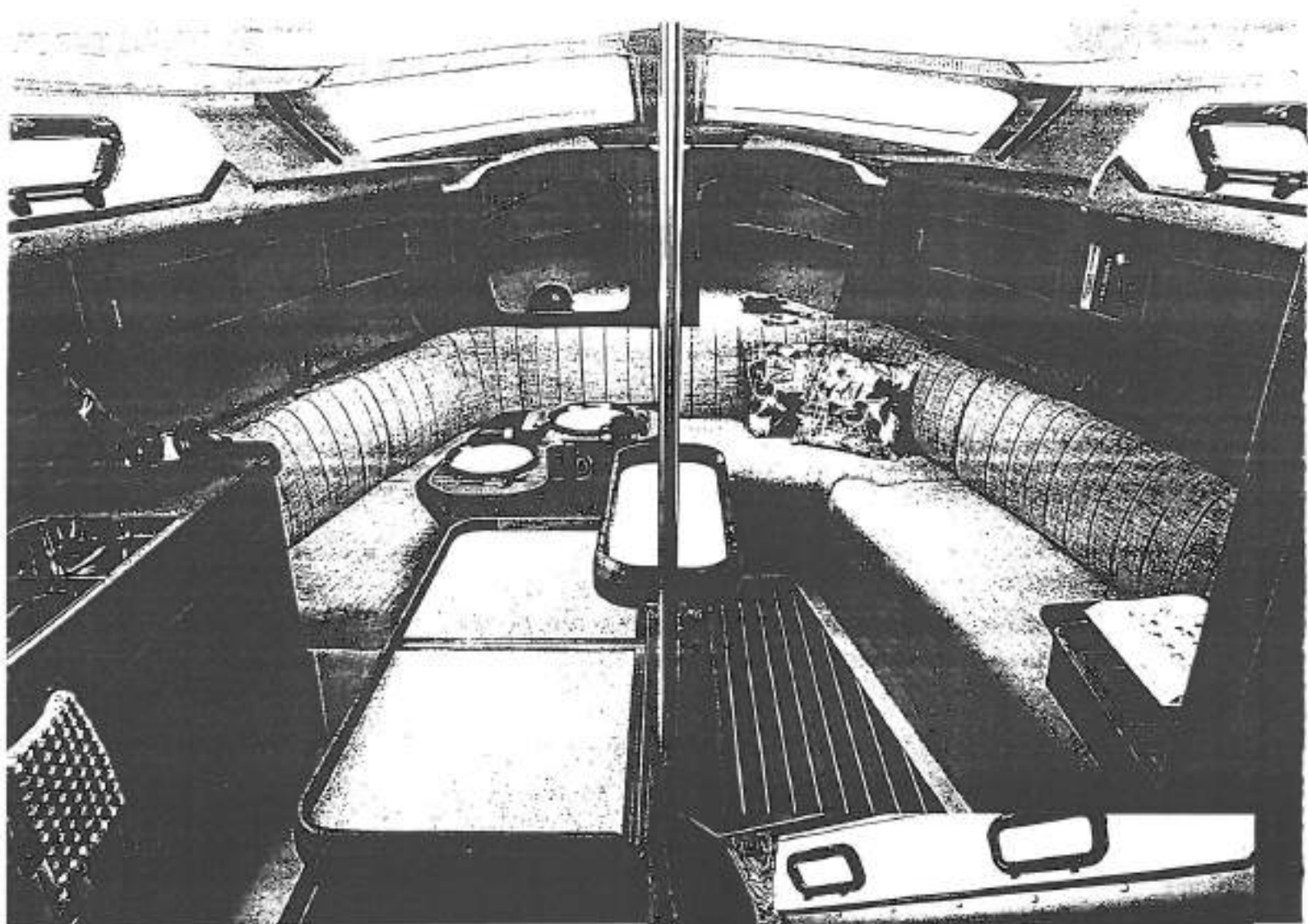

Simplified sailing and comfort were primary goals in designing the fun to sail, comfortable to cruise, Vision Series.

The U-shaped main salon follows the clean, modern cabin lines with a wrap-around windshield for a panoramic view, which gives a bright, open feeling throughout the cabin. The galley is complemented by a double sink, stove/oven, plus an island ice chest



which is both convenient and unique. Beyond the main cabin is a large head that includes a shower stall, generous headroom, and good ventilation. Aft, is a huge private stateroom with standing headroom, plenty of stowage and private access to the head. Corian® galley and vanity countertops, thick teak cabinet fiddles, hand rubbed and sealed teak bulkheads and cabinets are all selected to increase the durability and function of the 32.

We invite you to view the new Vision 32, and see why we believe the blend of cabin and cockpit comfort combined with simplified sailing performance are perfect for your cruising needs.

For the new
HUNTER STORY VIDEO

please send a check for \$5.00

<https://www.boatmanuals.com/>

Simplified Sailing

Tapered mast bends off, "spilling off" mainsail, lowering center of effort (CE) to increase stability.

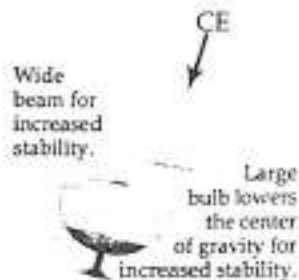

Single line reefing



Rogers' "captive" Super Slides



Electric halyard winch



Line organization



Total cockpit controls



The Vision series is an exciting new direction focused on simplifying your sailing.

The heart of this new design is a free standing rig; free of shrouds, backstays, spreaders, and the associated adjusting and fiddling that the traditional rig requires. The Hunter Design Group, with Warren Luhrs' careful direction, has blended a simple sailing rig with loads of features, to enhance stability and sailing ease, plus create new levels of comfort in your cruising.

An electric halyard winch, Isoreef single line

reefing, Roger's "Captive" mainsail super slides, and all lines leading aft, work together to allow a simple pull of a line or push of a button to easily control your Vision. And all are handled from the wide, deep, comfortable cockpit.

Cruise-Pac® standard features also include headsail furling, electronics, stereo, cockpit shower, an assortment of safety gear, plus much more. Call your Vision dealer, and experience the simplified fun of sailing a Vision.

Hunter Vision 32

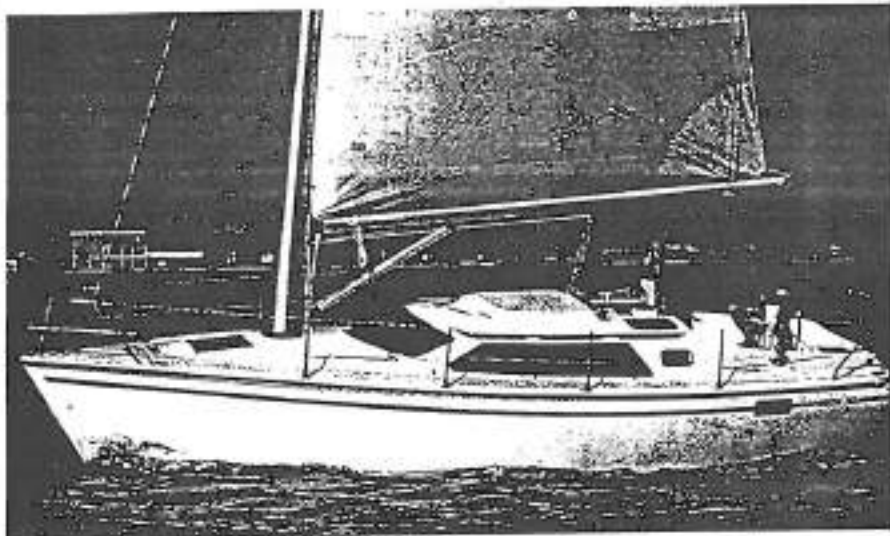

We stepped aboard Hunter Marine's entry in the free-standing spar sweepstakes with a healthy degree of polite skepticism. But after discarding a host of preconceived prejudices, we found ourselves aboard a boat with loads of handy features and an overall layout perfect for all sorts of coastal escapades.

Unfortunately, the weather failed to cooperate for an honest sailing evaluation. Beating up Florida's narrow Manatee River in a light and fading headwind—easily this rig's meanest nemesis from a point of sail perspective—we managed some decent forward motion but could tack through no better than 120 degrees. All sail handling/reefing controls are led crisply aft, but it was left to our imagination to conjure how they would harness the big, fully-battened main cracked off in a decent breeze.

From a design standpoint, the boat begs comparison to the recent line of Gary Mull-conceived Freedoms. Though similar in profile, with gargantuan mains and blade jibs, the Hunter design team has opted for an aluminum, rather than carbon-fiber, stick.

Above and belowdecks, the space is both liveable and refreshing. The swim ladder and open transom demand overboard shenanigans; the athwartships after cabin could accommodate Lyle Alzado and Mama Cass. You won't want to cross the Atlantic, but for over-nighters and coastal explorations the Hunter Vision 32 offers good value and good fun.

—Herb McCormick

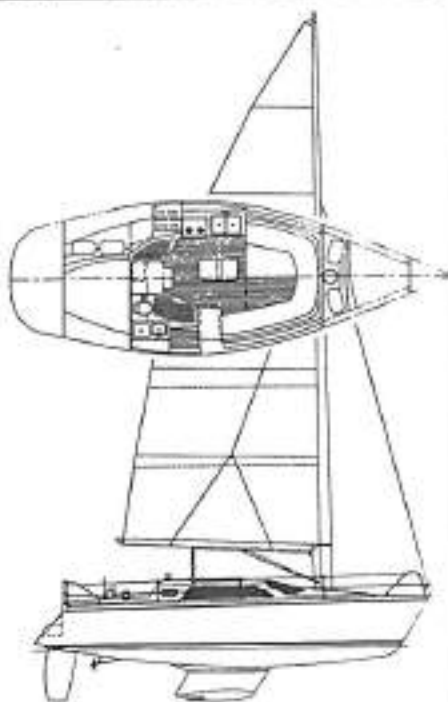

LOA	32'0"
LWL	27'0"
Beam	11'4"
Draft	4'3"
DSPL	11,400 lbs.
BAL	4,500 lbs.
SA	567 sq. ft.
DSPL/length	256
SA/DSPL	17.8
Aux Yanmar diesel	27 hp.

Hunter Marine Corp., P.O. Box 1030,
Alachua, FL 32615 904/482-3077

Construction/Rig: Solid, hand-laid fiberglass hull internally reinforced by one-piece, box-beamed grid system bonded by glass to hull like a bulkhead for torsional strength. Free-standing Isomat anodized tapered spar has a base resembling a young Sequoia and is built of high-grade No. 6061 T-6 aluminum with quarter-inch wall thickness. UK full-battened main with lazy jack system and three quarter hank-on blade jib standard. Unlike the Freedom rig, the Vision 32's jib has a slight overlap and is not self-tending. Roller furling headsail system optional for owners who want all sail controls in cockpit.

Underbody/Deck layout: Shoal draft bulb wing keel and spade rudder. Walk-in transom, swim platform/ladder, aft storage lockers and pressure shower are accessed by "convertible" helmsman's seat that lifts out and has built-in notches attached for stem pulpit storage when not in use. Emergency tiller access just aft of Edson pedestal and wheel. Halyards and reefing lines lead aft to cockpit beneath forward-facing half-inch plexiglass windshield and coachroof hood to sheet stoppers and Barient 22 self-tailing secondary winches. Slipping windshield has snap-on vinyl cover for nighttime privacy belowdecks. Barient 21 primary winches, Schaefer traveler system, two Beckson and two Lewmar opening ports standard. Stainless steel recessed grabrail runs length of cabin top.

Interior: Roomy U-shaped saloon receives plenty of natural light from wraparound windshield. Convertible dinette table easily accommodates 6 adults when in the foldout position, or can convert to mammoth central berth. Double V-berth forward, athwartships double cabin aft measures 7½ feet along one length, 6½ feet along the other. Galley includes double stainless steel sink, Origo 2-burner alcohol stove, "island" icebox with Corian laminated countertop.

Standard features: The Vision 32 is equipped with plenty of standard items including Combl stereo with 4 speakers and AM-FM cassette deck, 50-foot 110V built-in shore power cord, fire extinguisher, life jackets, signal horn, even a copy of Chapman's *Piloting, Seamanship and Small Craft Handbook*.

Hunter Vision 32

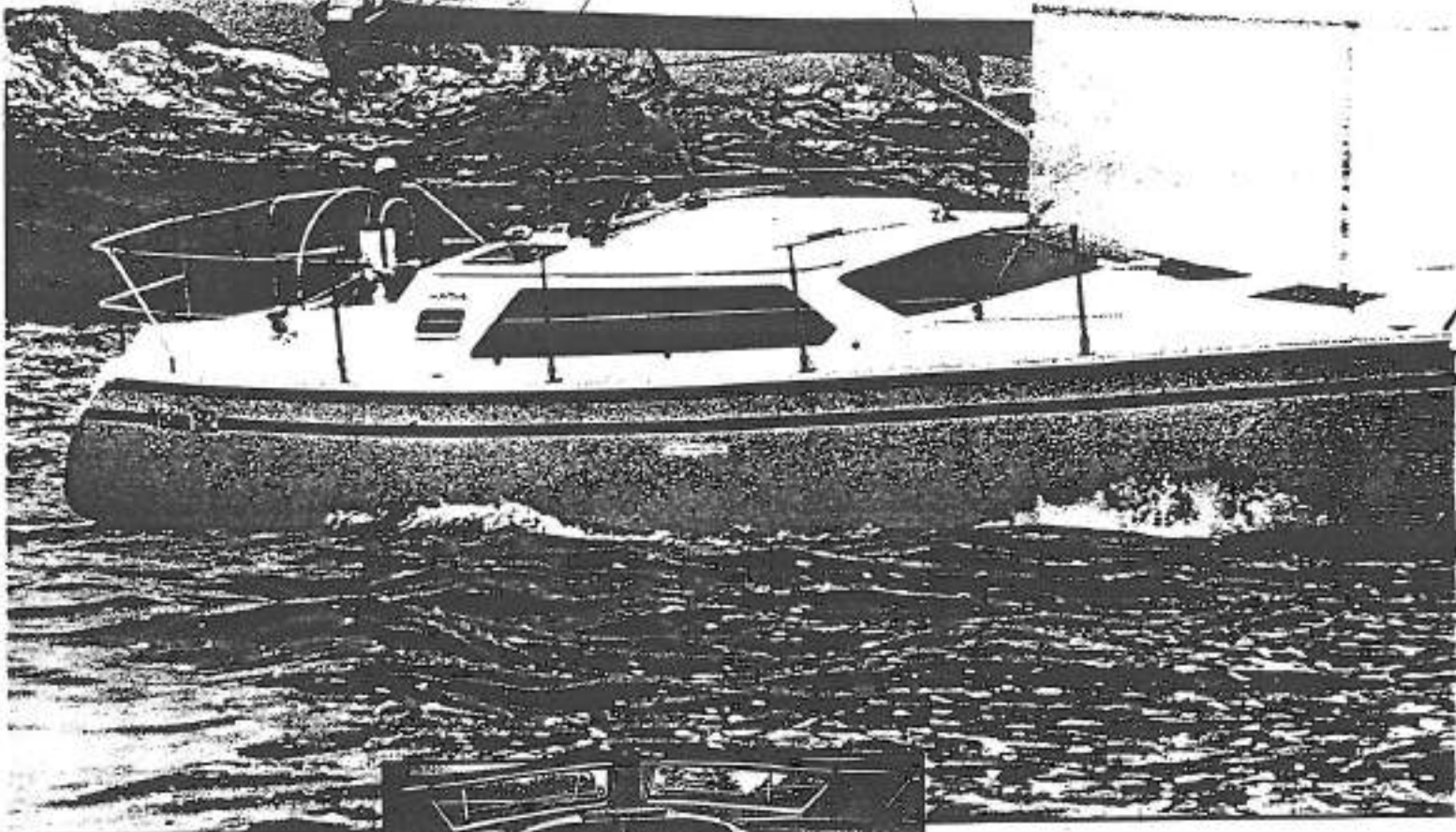

This high-volume hull lends itself to a spacious C-shaped settee. The "Island" icebox lets the cook brace himself.

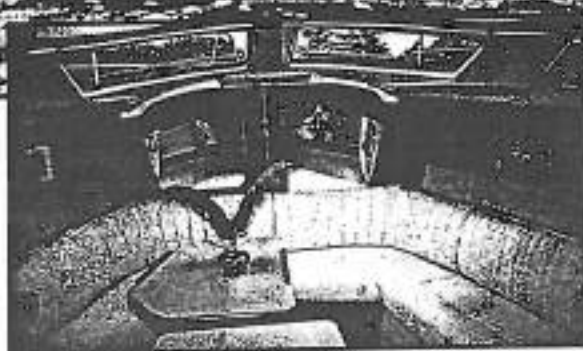

DEBBY CONSER

"I started out sailing in a Kite (a cat-rigged dinghy), so sailing with this rig is just like the old days, almost," Arnold said. Indeed, with the full-batten main and 110-percent jib, the rig is extremely well-balanced and responsive. The boat will sail well on the main alone—it has a full roach, but is not

extremely full at the head, like a dinghy sail.

"There are a few things to teach buyers about the boat, especially those who learned to sail with traditional stayed rigs," Arnold said. "You can tack the boat a lot more quickly than you think; the jib doesn't hang up on

the shrouds, although you need to get it inside the bow pulpit. When dropping the main, you've got to be dead into the wind so the lazy jacks will catch it, and you've got to reef sooner because the main is so big. Most people don't think about reefing until their boats are really stressed. With the single line reefing system, you can get in the habit and be able to sail in heavier conditions longer and more comfortably."

All sail handling controls are led to the cockpit under the fiberglass companionway hatch cover, through jammers to a pair of Barient 22s on the coachroof—main and jib halyards,

Inching off a lee shore in light air is easily accomplished with the Vision's efficient sailplan.

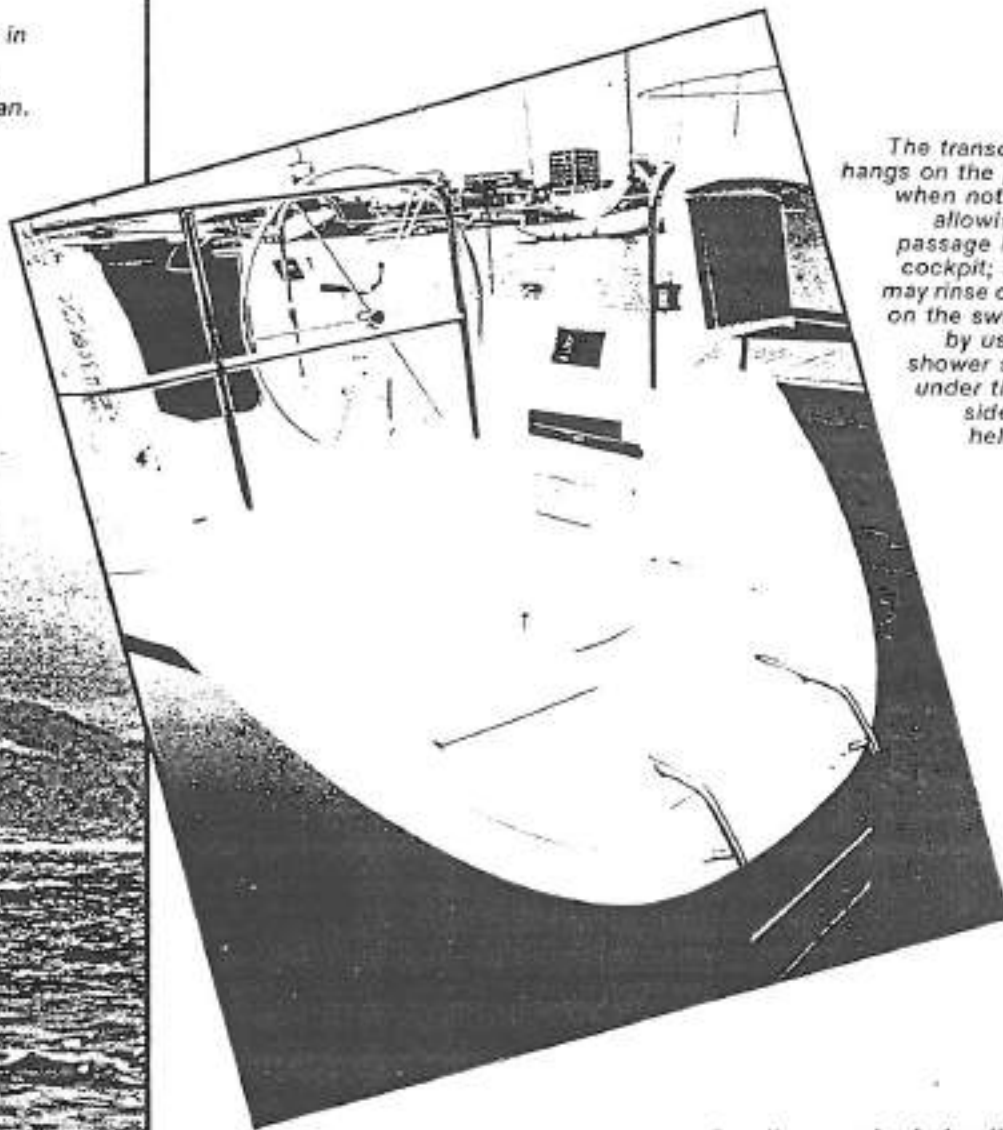
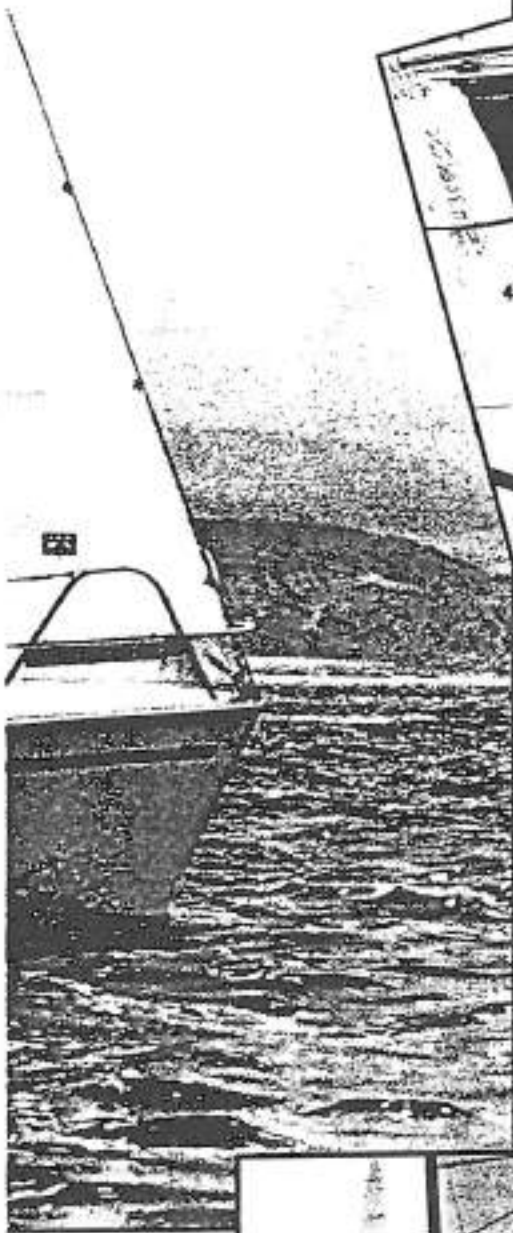

The transom gate hangs on the pushpit when not in use, allowing easy passage into the cockpit; bathers may rinse off while on the swim step by using the shower stashed under the right side of the helm seat.

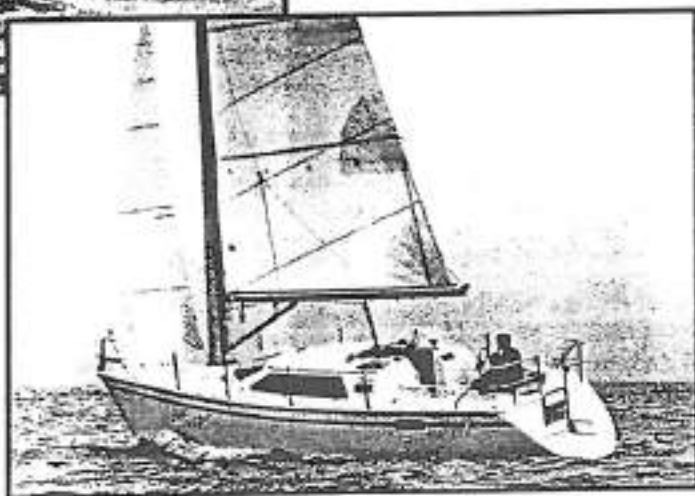

The optimum spot to steer is from the leeward side and the design of the cockpit coamings makes this easy and comfortable.

reefing line, mechanical solid boom vang. The main traveler is also on the cabintop at the companionway. Arnold added a jib downhaul line that attaches to the halyard shackle or top hank, runs the length of the headstay, through a block at the tack and leads back to the aft starboardside mooring cleat.

"I saw this in a magazine and thought I'd try it out," Arnold said of the simple downhauler. This simple bit of rigging ensures that no one needs to go to the dinky foredeck, which is made smaller by a smoked plastic hatch in the middle with no nonskid on it. It also keeps the sail from blowing back up the headstay until you're ready to bag it.

"The new sail-handling systems may take a while for people to accept, but like self-tailing winches and single-line reefing, and other innovations that evolved from the discoveries of single-handers, people will see they're the way to go," Arnold said.

Among the other clever details on deck was Hunter's roll-up mainsail

Continued on page 95

PACIFIC MARINE PROPELLERS, INC.

Since 1948

Inboard • Outboard
Stern Drive Pleasure Boats
Work Boats



"Carry A Spare Prop Oar Else"

REPAIRS AND LARGE STOCK OF PROPS

- BEARINGS
- SHAFTING

VISA/MC

3781 Dalbergia St., San Diego, CA 92113
Main St. & Nat'l City Blvd., Exit I-5

(619) 239-0129

CALIFORNIA TOLL FREE
1 (800) 24-PROPS

CIRCLE NO. 40 ON READER SERVICE CARD

If You Enjoy Boating YOU WILL LOVE *The Colorado River*



GUIDE

*to the
Western Sunbelt*
and COLORADO RIVER

• News • Information • Boating • Fishing • Sports • Travel
• Recreation • History

Only \$7.40
for 12 monthly issues
(\$12.40 in paper)

NAME: _____

ADDRESS: _____

CITY, STATE _____

ZIP _____

send check or money order to: Western Sunbelt Publ., P.O. Box 1433, LHC, AZ 86403

HUNTER 32 *Continued from page 85*

cover, built by Ulmer-Kolius, which attaches to the foot with a fat nylon zipper. No gaskets are needed because the main flakes itself inside the lazy jacks, so all you do is neaten it up a bit, unzip the cover on the port side, put it over the sail and zip it up on the starboard side.

Sailing the 32 proved to be as effortless as the company's promotional material promised, and for the retired couple who doesn't want to give up sailing, or the young family who have their hands full with small children, this boat could be the optimum coastal cruiser.

The Edson steering pedestal is situated well aft of the main seats so there is room for four to sit in the deep cockpit while the skipper drives from the raised helm seat or the leeward rail. The aft coaming is angled so correctly that I declared this the first helm station where I could lean out, steer, observe my telltails and the slot, and feel right about it. The steering is positive, but not stiff, with one and a half turns, lock-to-lock. The rudder post is just aft of the wheel (with a deck plate available for removal to install an emergency tiller) and the quadrant is visible through the sole.

Edson's setup is perfectly usable, but the throttle is stiff and its plastic lever just too flexible to adjust the engine rpm smoothly while under power. Why can't these puppies be stiffened up or made out of metal? A similar balky unit on a 34-footer I cruised to Catalina almost got me in trouble while negotiating a buoy mooring at Fourth of July Cove last fall. It's not nice to crash borrowed boats and I didn't start a trend, but it was a close enough call.

On our daysail, we had no more than six knots of wind, but the boat gathered speed up to four knots on a close reach. On the wind, it points quite high and it's fairly stiff. Drawing only four feet three inches, it is shallow-bilged and equipped with a bulb-wing keel.

"A lot of thought went into the keel design," Arnold said. "Hunter came up with the bulb-wing through a blind test situation. They built four 26.5s, one with a tandem keel, one with a fin, one with a wing and one with a bulb-wing. Four different skippers sailed each of the boats without knowing which boat he was on, and unanimously voted the bulb-wing boat as the best performer. I was skeptical at first—I'm a deep-fin keel man myself—but after a year or so, I'm a convert."

The design gets plenty of weight down low and, combined with its elliptical rudder, makes a pretty fast underbody on this boat, which also has a lot of waterline for a boat of its size (27 feet).

That long waterline and the boat's 11-foot, four-inch beam give the hull incredible volume, immediately obvious when you step below. The low coachroof is made visibly lower by the wraparound forward portlights.

With the mast stepped so far forward, the saloon is immense. The U-shaped settee runs continuously from the nav station forward of the head to the galley on the starboard side amidships. The table, which folds in half, can seat three to six and it collapses to form an insert to convert the saloon into a huge playpen berth. The installation is neat, but the cushions don't fit together so well and the leg rolls on the edge of the seats, even with the upholstered insert, form big lumps in the new bunk. You could be comfortable there for an afternoon of reading in the rain, but not all night.

There is a compact forward vee-bunk that you crawl into through cutouts in the forward bulkhead, and an enclosed aft stateroom under the cockpit with a roomy, stand-up changing area next to a hanging locker. The navigation station

is opposite the galley and includes an opening chart table, an edition of Chapman's is standard, and you have room for a compact VHF, Loran, AM/FM radio (which comes with the basic boat), 110v outlets and a light.

The galley is compact, but not cramped and the cook has the "island" icebox, installed just off centerline, to brace against when cooking underway. The Corian counter tops in the galley and on the icebox are thoughtful touches, but they don't have fiddles. There is plenty of stowage—in five little galley drawers, under the sink, behind teak roll-up doors outboard of the settee backs. Two 110v shore power outlets are standard here and in the head.

The head, which comes standard with a shower, has a mirrored plastic door above the sink that does double-duty securing a storage compartment. An opening port in the overhead provides light and ventilation.

The engine box is conveniently placed under the companionway steps and you have five different ways to get at it. The top and steps come off, as do three other panels.

The new upholstery fabrics in use aboard cruising sailboats today are of tasteful texture and color, but there is virtually no place below that could accommodate wet sails, dripping foulies, scaly fishing gear, or wet people without getting soaked and staying that way. The Hunter is in the same predicament. You could, in a pinch, put things on the cabin sole, and hang slickers in the head. A chain locker in the foredeck takes care of ground tackle, and a shallow lazaretto under the portside cockpit seat can accommodate mooring lines, fenders and boat hooks, but probably not an inflatable dinghy.

Finally, the walk-through transom's removable center section is engineered to hang on the pushpit and the molded-in swim step/seat makes clambering aboard from the swing-down ladder easy for the children and grandpa. A hot/cold freshwater shower is standard and stows away in its own compartment under the starboard side of the helm station.

The 32 is a true '80s production boat that has incorporated many design details seen in popular European cruising yachts like Beneteau and Jenneau—the swim step stern, the wrap-around portlights, the all-plastic heads making showers a part of every weekend, and the low cabin trunks that fair into the foredeck create a sleek, modern look.

Also, Hunter's practice of "packaging" the boats with a full complement of standard equipment like an anchor and rode, life jackets, two 12v batteries, fire extinguisher, emergency tiller, signal horn and an edition of "Piloting, Seamanship and Small Craft Handling," by Chapman, give you a firm, realistic base price. ♣

Hunter 32

LOA	32'
LWL	27'
Beam	11'4"
Displacement	11,400 lb.
Ballast	4500 lb.
Draft	4'3"
Working Sail Area	567 sq.ft.
Propulsion	Yanmar 27-hp diesel
Tankage:	
water	45 gal.
fuel	22 gal.
Base price	\$63,000

Builder:	Dealer:
Hunter Marine Corp.	Eddie Arnold Sailboats
Dept. TWB	Dept. TWB
P.O. Box 1000	2001 W. Coast Hwy.
Alechar, FL 32815	Newport Beach, CA 92663
(904)420-3077	(714)442-4786

LOWEST PRICES IN THE WEST

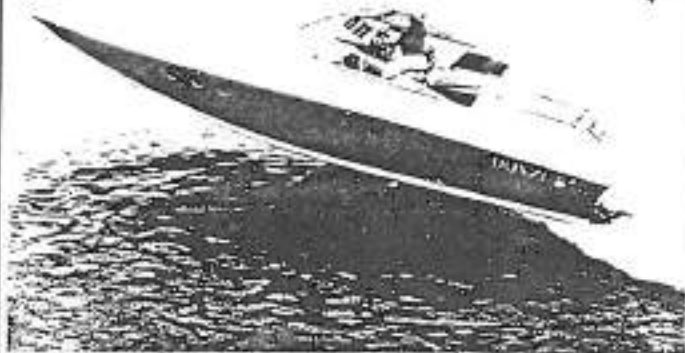

DONZI

BLACKWIDOW

See Donzi's Remarkable Z-Boats, Classics, Fishingboats, and Ragazzas.



3101 Pacific Coast Highway
Newport Beach, CA 92663
(714) 651-0600

8340 East Raintree Drive
Scottsdale, AZ 85260
(602) 991-1971

CIRCLE NO. 41 ON READER SERVICE CARD

OMC Cobra SEASWIRL



* July-August Special *

1989 SIERRA 18' I/O OMC V-6 FULL CANVAS AND TRAILER—\$13,900 + T/L

JOHNSON MARINE Since 1955
1237 HOLT BLVD • ONTARIO, CA 91762

Also Dealer For:
EVINRUDE OUTBOARD

(714) 986-1189

OPEN 8-6 Tues-Sat; Closed Sun & Mon

CIRCLE NO. 42 ON READER SERVICE CARD

VISION 32 RIGGING SPECIFICATIONS

STANDING RIGGING

FITTINGS

<u>Description</u>	<u>Wire Size</u>	<u>Upper End</u>	<u>Lower End*</u>	<u>Overall Length</u>
Headstay	7/32 1x19	Marine eye	7-12-12	33'9 3/4"

- * "X-X-X" represents the tumbuckle size as follows:
Wire size - body size - pin diameter in 32nd's of an inch. Example"
7-12-12 is a diameter in the tumbuckle that accepts a 7/32" wire, has a
3/8", (12/32"), thread diameter in the body, and uses a 3/8", (12/32") pin.

RUNNING RIGGING

<u>Line</u>	<u>Size</u>	<u>Attachments</u>	<u>Overall Length</u>
Main Halyard	7/16"	Headboard shackle	115'
Jib Halyard	3/8"	Snapshackle	83'
Main Sheet	7/16"	Eye splice	56'
Jib Sheet	3/8"		35'
Traveller Control Lines	3/8"	Eye splice	19'
Lazy Jack	3/8"		50'
Lazy Jack Vinyl	3/16" 7x7	Two Thimbles	20'
Anchor Line	1/2"	Shackle	150'

All lines low stretch Dacron except anchor line which is nylon.

All rigging is supplied by SECO SOUTH.

VISION 32 OWNER'S MANUAL

OWNER'S MANUAL

I. INTRODUCTION

- A. Brief History
- B. Warranty Card
- C. Welcome To The Hunter Marine Family
- D. Glossary of Sailing Terms (6 pages)

II. GENERAL HANDLING & OPERATION

- A. Pre-departure Check List
- B. Float Plan
- C. Closing Up Your Boat After Sailing
- D. For Safe Boating
- E. General Handling & Operation

III. SAILS & RIGGING

- A. Vision 32 Sail Plan - dwg. #V32A2636
- B. Tuning and General Mast Information
- C. Vision 32 Lazy Jacks
- D. Vision 32 Mast Installation - dwg. #V32A2620
- E. Vision 32 Running Rigging - dwg. #V32A2618
- F. Vision 32 Traveller Detail - dwg. #GENA2611
- G. Vision 32 Rigging Specifications
- H. Vision 32 Deck Layout (two pages) - dwg. #V32A2633
- I. Vision 32 Rigging Lengths - dwg. GENA2605
- J. Vision 32 Spinnaker Package - dwgs #V32A2634 & #V32A2635
- K. Mast Step Detail V32A2650
- L. Mainsheet Vang Layout V32A2652

IV. ELECTRONICS

- A. Marincos Shore Power Cable Set Instruction Sheet
- B. Marincos Boaters Guide
- C. Entertainment Owner's Manual
- D. Autohelm ST50 Speed Manual
- E. Autohelm ST 50 Depth Manual
- F. VHF Radio

VISION 32 OWNER'S MANUAL

OWNER'S MANUAL

V. GALLEY/HEAD SYSTEMS

- A. Water System Operation
- B. Alcohol Stove Instructions
- C. Manual Marine Toilet
- D. Automatic Water System Pump
- E. Electric Water Heaters
- F. Grohe Faucets - Specialty, Centerset, Kitchen & Bar

VI. SPECIFICATIONS & TECHNICAL INFORMATION

- A. Vision 32 Interior Plan - dwg. #V32A2632
- B. Vision 32 Thru-hull Location - dwg. #V32A2631
- C. Vision 32 Supply Water System - dwg. #V32A2625
- D. Vision 32 Waste Water System - dwg. #V32A2626
- E. Vision 32 Head Plumbing Diagram - dwg. #GENA2620
- F. Vision 32 Auto Bilge Pump Layout - dwg. #GEN2613A
- G. Vision 32 Engine System - dwg. #V32A2624
- H. Pumps, Strainers, & Filters
- I. Vision 32 Pan Electrical System - dwg. #V32A2630
- J. Vision 32 Headliner System - dwg. #V32A2629
- K. Vision 32 Light Bulb Specifications
- L. Vision 32 Curtain Diagram - Dwg. #H32A2619
- M. Vision 32 Filler Cushion Storage
- N. Winch Wiring Diagram HUNA1803

VII. MAINTENANCE

- A. Instructions For Preparation For Bottom Painting
- B. Teak Care
- C. Maintenance (3 pages)
 - 1. Engine, Transmission and Drivetrain
 - 2. Steering
 - 3. Electrical Systems
 - 4. Plumbing Systems
 - 5. Fuel Systems

VISION 32 OWNER'S MANUAL

OWNER'S MANUAL

Maintenance Continued.

- 6. General Care/Fabric Care
- 7. Winch Maintenance
- 8. General Hardware Maintenance
- D. Maintenance Electrolysis & Galvanic Protection
- E. Alignment Procedure
- F. Alignment Diagram - dwg. #GEN2619A
- G. Storage & Winterization (two pages)
- H. Corian (R) Care & Cleaning
- I. Viplax Acrylics Care & Cleaning
- J. Edson Pedestal Maintenance Guide
- K. Marine Rigging
- L. Barient Service Manual #2

VII. GENERAL INFORMATION & WARRANTY CARDS

- A. Edson International Registration Card
- B. UK Sailmakers/Warranty Registration Card
- C. Hunter Marine Limited Warranty
- D. Hunter Five Year Bottom Blister Limited Warranty
- E. Compass Warranty & Information
- F. Nationwide Battery
- G. Seaward Product Information & Warranty
- H. Racor Fuel Filter Information
- I. Grohe America
- J. Perko Water Strainer
- K. Foss Rudder Information

IX. BOATING SAFETY

- A. Coast Guard Auxiliary Public Education
- B. Courtesy Marine Examination
- C. Federal Requirements for Recreational Boats

VISION 32 DECK HARDWARE LAY-OUT (see diag.)

	PART	MANUFACTURER	MFG.#	HUNTER PART #
1.	Stem plate w/roller	Southcoast	NA	HW1578
2.	Bow rail	Southcoast	NA	HW2378
3.	Water tank fill	Nordic	6124-00	PL1130
4.	Mooring cleat	Y/S	YS7107E-8"	HW0975
5.	Hunter hatch, fwd.	Custom	NA	KC010008
6.	Genoa track	Schaefer	SK6300	HW0315
	End stop	Schaefer	74-35-G	HW0293
	Block lead	Schaefer	32-88	HW0294
	Bullseye	Schaefer	615	HW0172
7.	Halyard lead block, sm.	Isomat	559-232S	RI0536C
	Halyard lead block, lg.	Isomat	559-232L	RI0536D
8.	Deck organizer	Garhauer	10-90	HW0170
9.	Handrails	Custom	NA	HW2438
10.	Opening port, thru plexi	Beckson	PO414DBS20	HW0023
11.	Mainsheet traveller	Schaefer	SK6198	HW0203
	End stop	Schaefer	74-93	HW0205
	Car	Schaefer	72-92	HW0238
	Block, single	Schaefer	701-03	HW0242
	Block, port	Schaefer	74-58	HW0245
	Block, starboard	Schaefer	74-59	HW0246
12.	Hunter hatch, aft	Custom	NA	KC010017
13.	Companionway sldr. track	Bomar	NA	HW0178A-32'
14.	Pinboard keeper	Bomar	NA	HW0179A-32'
15.	Opening port, cockpit	Lewmar	NA	KC010058
16.	Inspection port	Perko	DP40-W	HW0045
17.	Diesel fuel fill	Nordic	6125-03	PL1126
18.	Stem rail	Custom	NA	HW2288
19.	Swim ladder	Custom	NA	HW2158
20.	Stanchions	Custom NA		HW2078
21.	Sheet stopper	Garhauer	11-13	HW1280
22.	Opening port, thru deck	Lewmar	8912	HW0049
	Screen	Lewmar	8912	HW0049A-32'
23.	Halyard winch	Bariet	22-39CST	HW2544
	Winch handle	Bariet	10CX	HW2564
	Winch handle	Bariet	V10LIC	HW2566
24.	Turning block	Schaefer	501-39	HW0312
25.	Primary winch	Bariet	21-33	HW2542
26.	Engine panel cover	Custom	NA	HW3389F
	Engine stopswitch/cable	Yanmar	NA	HW3389E
27.	Cockpit shower	Stowaway	48500	PL0189
28.	Waste pump out	Nordic	6126-00	PL1140

VISION 32 OWNER'S MANUAL

OWNER'S MANUAL

Boating Safety Continued.

- D. ASA Pamphlet
- E. Boating Basics - Blueprint For Safe Boating
- F. Visual Distress Signals for Recreational Boats
- G. Getting Help on the Water
- H. Tips for Safe Boating

X. ENGINE INFORMATION & WARRANTY

- A. Yanmar Owner's Manual
- B. Yanmar Warranty Card
- C. Mack Boring Bulletins
- D. Yanmar On-Board Spare Parts Kit
- E. Yanmar Diesel Engine Delivery Report

PRE-DEPARTURE CHECK-LIST

- Check bilge for excess water.
- Check weather conditions and tides.**
- Check food supply.
- Foul weather gear.
- Linen, sleeping bags.
- Fuel.
- Water.
- Sunscreens and sunglasses.
- Tools.
- Docking and anchor gear.
- Check radio operations.
- Navigation charts and instruments.
- Float plans to a friend or Coast Guard.** *(See next page.)*
- Fuel for stove.
- Cooking and eating utensils.
- Check battery water level.
- Oil level, tight V-belts.
- Check for loose electrical connections in engine room.
- Secure tools or any loose equipment in engine room so as not to get fouled in engine.
- AC systems off; electrical cord stowed.
- Doors and drawers secured.
- Check steering lock to lock.
- Check mast for rigging irregularities and tightness.
- Halyards and sheets are clear and ready to run.
- No lines or other obstructions near the propeller or bow.
- Anchor ready to run.
- Check lifelines for tightness.
- Turn on fuel and water lines.
- Stow all loose gear.
- Open engine cooling water intake thru-hull valve.

FLOAT PLAN

1. Name of person reporting and telephone number:

2. Description of boat:

NAME _____ TYPE _____
MAKE _____ LENGTH _____ REGISTRATION # _____
HULL COLOR _____ STRIPE COLOR _____ DECK COLOR _____
OTHER DISTINGUISHING MARKS _____

3. Persons aboard:

NAME	AGE	PHONE #
_____	_____	_____
ADDRESS _____		
NAME _____	AGE _____	PHONE# _____
ADDRESS _____		
NAME _____	AGE _____	PHONE # _____
ADDRESS _____		

4. Engine:

TYPE _____ H.P. _____ FUEL CAPACITY _____

5. Safety equipment:

PFDs Flares Mirror Flashlight
 Food Water EPIRB Raft/Dinghy

6. Radio:

TYPE _____ FREQUENCIES _____

7. Trip expectations:

DEPARTING AT (APPROX. TIME) _____ ON (DATE) _____ FROM (LOCATION) _____
GOING TO (LOCATION) _____ RETURNING (DATE) _____ IN NO EVENT LATER THAN (TIME & DATE) _____

8. Automobile:

LICENSE # _____ STATE _____
MAKE _____ COLOR _____ PARKED AT _____

9. If not returned by _____, call the Coast Guard or:

at: _____

CLOSING UP YOUR BOAT AFTER SAILING

When leaving your Hunter, Legend, Passage or Vision at the dock for more than a short time, it is a good idea to review the following check list to make sure everything is in order. This will help protect the various parts of your boat and add considerably to their attractiveness and usable life.

- Fold and bag headsails and stow below.
- Furl mainsail and cover, or remove and also bag.
- Remove and stow all portable deck hardware such as snatch blocks, winch handles, etc.
- Secure the boom to the topping lift and set it firmly amidships with the mainsheet purchase. (It is also a good idea to rig a line from the steering wheel or tiller to a convenient cleat to keep the rudder from swinging back and forth with the motion of the water.)
- Attach the shackle ends of all halyards to convenient fittings and take up slack.
- Cleat and coil halyard tails and permanent sheets, hanging them off the deck to promote drying.
- Coil and stow all other lines.
- Cover the winches and steering pedestal when leaving the boat for several days or more.
- Close all fuel lines and gate valves.
- Turn off the electrical system.
- Pump the bilge.
- Check air vents, secure ports and hatches, and swab the deck, particularly if you have operated on saltwater.
- Make a final check of mooring lines, chafing gear, fenders, etc.

FOR SAFE BOATING

BE PREPARED

Take a safe boating course from the Coast Guard. You can call 800-336-BOAT for information on courses in your area.

Carry all safety equipment required by federal and state law. Federal requirements are discussed in "Federal Requirements for Recreational Boats" which can be acquired from U.S. Coast Guard Office of Boating, Public, and Consumer Affairs, Washington, D.C. 20593. State requirements will come from your local State Boating Administration. The Coast Guard also recommends a first-aid kit, a pump or bailer, a transistor or weather radio, extra fuel, a paddle, anchor and line, and extra drinking water; also, if not a requirement, flares.

Get a Coast Guard Auxiliary Courtesy Examination. This is a free, confidential safety inspection. Call your local Coast Guard Auxiliary for details.

Be familiar with the use of distress signals and PFDs.

AVOID FIRES

Handle fuels carefully.

Read labels on any stove fuels.

Read the engine owner's manual for proper fuel-system maintenance and inspect your engine's fuel system periodically.

Heed fire extinguisher regulations and keep them in good condition.

While refueling:

- Fill the portable tanks on the dock.
- Tie the boat securely.
- Extinguish cigarettes and all flames on the boat. Turn off all engines and electrical equipment.
- Keep the hose nozzle in contact with the fuel can or fill.
- Wipe up all fuel spillage.
- Ventilate the engine and fuel compartment.
- Check boat for fumes.

BEFORE GETTING UNDERWAY

Leave a float plan. (See example under Float Plan)

Perform pre-departure check list. (See Pre-departure Check List)

Check the weather: do not venture out if the weather is threatening.

WHILE UNDERWAY

PFDs should be worn by children and non-swimmers at all times. *Everyone should wear them if conditions become hazardous.*

Do not operate a boat if intoxicated, fatigued or stressed. These human factors cause 50 percent of all boating accidents.

Keep a good lookout. This is especially true of sailboats. Keep a watch to leeward under the headsail. Keep away from swimmers, divers and skiers.

Obey state and federal laws. Know your local laws and "rules of the road."

Respect bad weather: try to get to shore if the weather turns bad. Get and carry a radio with a NOAA "weather band" on FM 162.40-162.55MHZ.

IF TROUBLE OCCURS

Radio for help. Use the emergency VHF, channel (i.e., 156.8MHZ).

Put on PFDs immediately.

Stay with the boat. In cold water, huddle together to prevent hypothermia.

FLOAT PLAN

Make copies of the Float Plan page and use before each trip. Fill it out and leave it with a reliable person who will notify the Coast Guard or other rescue organizations if you fail to return on time. Do not forget to cancel the float plan upon your return.

GENERAL HANDLING & OPERATION

Diesel Engine

An engine owner's manual is supplied with your boat and should be read thoroughly. The manual contains technical specifications, running instructions and maintenance schedule on lubricants and fluids. For long engine life, follow routine maintenance schedules.

You should check engine oil, transmission fluid and coolant levels. Water, rust, scale and dirt will cause serious damage to the injectors on diesel engines. You should check your filters frequently and change when necessary.

If you start your engine, run it a minimum of 15 minutes to bring it up to operating temperature. This insures that any condensation is evaporated. Your engine should "run-out" at 3/4 throttle at least once a month to clean out carbon build-up and moisture.

Starting:

1. Visually check engine compartment to see that the throttle linkage, shifting controls, electrical connections and fuel lines are properly secured.
2. *Before each start* check oil in engine and transmission.
3. Insure that engine shut-off cable is properly secured and operating.
4. Place the shift lever in the neutral position.
5. Move the throttle or "fuel" lever forward to approximately the half-speed position.
6. Insert the starter key and turn to the "on" position.
7. Press the starter button and hold until engine starts, then release. The buzzer and/or light should then go off.
8. Back the throttle off to an idle position (700 to 800 rpm); allow cold engine to warm up a minimum of five minutes.
9. Check that the lube oil pressure warning light and the charge lamp go off. If any of the warning lamps do not go off above 1,000 rpm, the engine is malfunctioning and should be stopped immediately. Consult your nearest engine dealer.

NOTE: To stop engine at any time, pull "engine stop" lever all the way out. Before stopping, however, it is a good idea to idle the engine in neutral for about five minutes, then race it in the full-throttle position for a moment, then return to idle and stop engine.

CAUTION: Do not turn safety main switch to "off" while engine is running. This can seriously damage the alternator.

Motoring:

If your boat is equipped with 110V shore power, remember to unplug it upon departure. When engine is warm, move the shift lever to forward and reverse to insure that it engages properly. To increase RPM's push throttle lever forward and pull back to decrease RPM's.

VISION SERIES

Your Vision is equipped with an aluminum mast. This mast is anodized to give the best possible corrosion protection for years of trouble free maintenance.

This free standing rig reduces tuning to the minimum. Once the mast is stepped only a small amount of tension is required on the forestay. This style of rig eliminates compression on the mast.

Since there is no backstay or shrouds, the bending moments are very substantial at the deck level. This is why it is very critical to not drill any holes within 3 feet of the deck level of this mast. If you wish to add spinnaker gear, it must be done above this point.

Another characteristic of the free standing mast is that the boom can swing past the 90 degree limit of the gooseneck bracket. It is very important to check the length of the mainsheet with the traveller set all the way to leeward. The boom must not be allowed to swing past the maximum 90 degree angle or the gooseneck bracket could be pulled off of the mast.

Another feature, is the single line reefing system. This system allows you to reef your mainsail with one line lead aft to the cockpit. Just ease off on the main halyard, and take up on the single reef line and both tack and clew of the sail will reef together. Thus eliminating the need to go to the mast to set the reef.

If you have to power through a seaway, you may find that the flexible mast swings forward, making the forestay slack when you go through waves. When the mast swings back, the forestay snaps tight putting unnecessary stress on the rig. Therefore attach the main halyard to the end of the boom and winch it tight against the mainsheet in such conditions to stabilize the top of the spar.

GENERAL HANDLING & OPERATION

Motoring Continued:

CAUTION: Your rigging will conduct electricity. Always check for overhead high tension wires before proceeding. Once clear, you may increase your speed in a reasonable and safe manner as desired.

IMPORTANT: Do not shift from forward to reverse or back without first lowering engine rpm to idle. When sailing, it is best to start the engine before the sails are lowered. This way, it is still possible to maneuver if the engine should not start.

Electrical System

Your Hunter is fitted with an electrical system designed for both AC and DC. While in port, you can operate any tool, appliance or other device designed to function on regular house current (120V) simply by plugging your dockside power cord into a convenient outlet on shore and turning your AC main breaker on.

CAUTION: Do not allow your dockside power cord to come in contact with the water. Never operate any AC power tool or other electrical equipment while you or the device are in contact with the water.

When leaving port, disconnect the dockside power cord and turn the main DC breaker on. This allows you to use the ship's lights and other equipment designed to operate on direct current. Keep in mind that your DC power source is a 12-volt battery and, just as with your automobile, it must be charged regularly by operating the engine. Unless a state of charge is maintained, there may not be enough power to operate the starter motor. Dangerous situations can result if the engine cannot be started when needed.

Make a regular visual check of battery(ies) to insure proper water level and inspect terminals for signs of corrosion. If your boat sits for long periods without use, it is often a good idea to remove the battery(ies) and attach them to a trickle charger to keep them fully charged and ready to use.

Water System

The water heater operates either on 120 volts AC or when the engine is running. To obtain hot water from the engine, it must run a minimum of one-half hour.

CAUTION: Do not turn the water heater on until you are sure the tank is filled with water. To do so will destroy the heating element, which is not covered by the warranty.

Pressure water pumps are the demand type. Once the circuit breaker switch is on, opening the faucet will produce water flow.

NOTE: Intermittent operation of the freshwater pump while all faucets are closed usually indicates a leak somewhere in the lines. Trace the lines to locate the leak and repair.

Please refer to your manual under Heads & Galley systems for more specific information.

GENERAL HANDLING & OPERATION

Toilet:

IMPORTANT: When not in use, lever must be left in the "dry" position to prevent flooding.

Before using, place the lever in the "wet" position and pump slowly to partly fill and wet the inside of the bowl. Return to "dry" position.

After using, return the lever to the "wet" position for flushing and pump until the bowl is thoroughly cleaned. Continue with several more full strokes to flush discharge lines. Return lever to the "dry" position and pump slowly until bowl is empty.

Note: Always close seacocks when sailing or when boat is not in use.

Pumps:

All pumps should be checked frequently to insure proper operation. *This is an especially important regular maintenance item since functioning of a pump could save your vessel from serious damage at some future time.*

Inspect all hoses for chafing and dry rot. See that hose clamps are tight. Check that the pump impeller area is clean and free of obstructions. Inspect electrical wiring for corrosion. Make sure float switch moves freely and is making an electrical connection.

Docking:

Docking your boat should be handled carefully to avoid potential damage. Under normal wind and water conditions, the following considerations should be made:

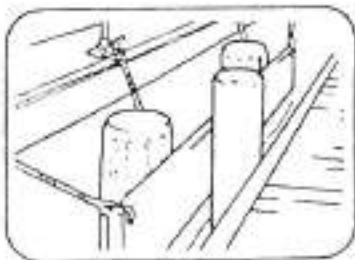

1. Whenever possible, your approach should be made against the prevailing wind and current to assist in stopping the boat. Where these conditions are contrary, the strongest should be used to determine approach.

2. Approaching the dock-dock lines and fenders should be at ready, loose gear stowed and decks cleared. Determine the

direction of wind and current, and, once you decide which side of the boat will be against the dock, rig dock lines and fenders on the appropriate side. One dock line should be attached to the bow cleat, another to the stern cleat opposite the side that will lie against the dock. **NOTE:** If the boat is to lie against a piling, rig a fender board across two or more fenders

GENERAL HANDLING & OPERATION

3. Tying up—attach bow and stern lines to dock, hauling boat in with fenders against dock. Rig crossing spring lines to limit motion forward and aft. Be sure to allow some slack in all lines to compensate for tidal activity if present. Never use bow rail, stern rail or stanchions to secure vessel, even for brief periods. For other types of moorings, or for abnormal wind or water conditions, consult your *Chapman's* or other approved boating guide.



Anchoring:

Your Hunter comes with an on-deck anchor well and a burying-type anchor as standard equipment. The anchor is selected to suit the size and weight of your boat under normal anchoring conditions, and provides its best holding characteristic in muddy or sandy bottoms.

When anchoring, pay particular attention to the scope of your anchor rode (i.e., the relationship between the depth of the water and the length of the rode). A good rule of thumb is to allow a scope of about 7:1 (a rode seven times as long as the vertical distance from the bow to the bottom). A helpful aid is to mark the rode every 20 feet or so with knots or other types of indicators. Before dropping anchor, make sure the bitter end is secured to the cleat in the anchor well.

Also, be sure to consider wind direction, currents, mean low tide depths and other local conditions when anchoring, as well as the positions of any boats already anchored nearby.

CAUTION: Anchoring in unusual water and/or weather conditions will require additional precautions. Consult your *Chapman's* or other approved guide for suggestions.

To weigh anchor, motor or sail (under main only) slowly forward. When at a point directly above the anchor, a quick tug should free it from the bottom. Take care not to damage the topsides when hauling the anchor aboard. It is good practice to thoroughly clean the anchor prior to placing it in the anchor well.

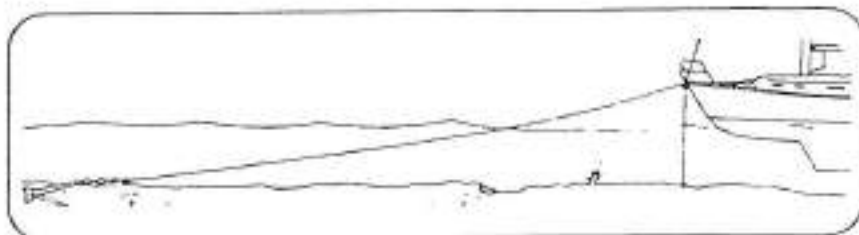

HUNTER

VISION 32 MAST STEP DETAIL V32A2650

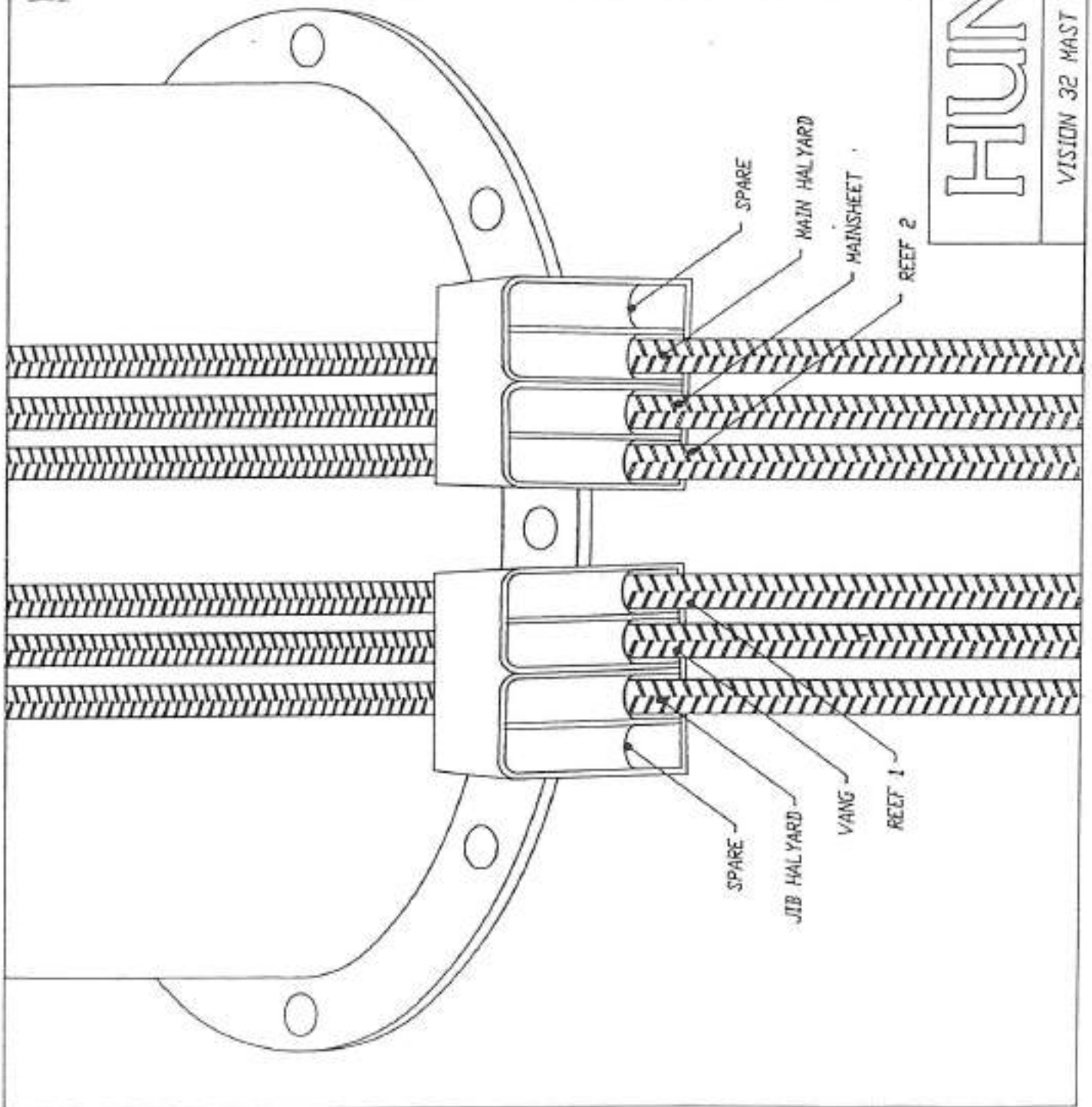

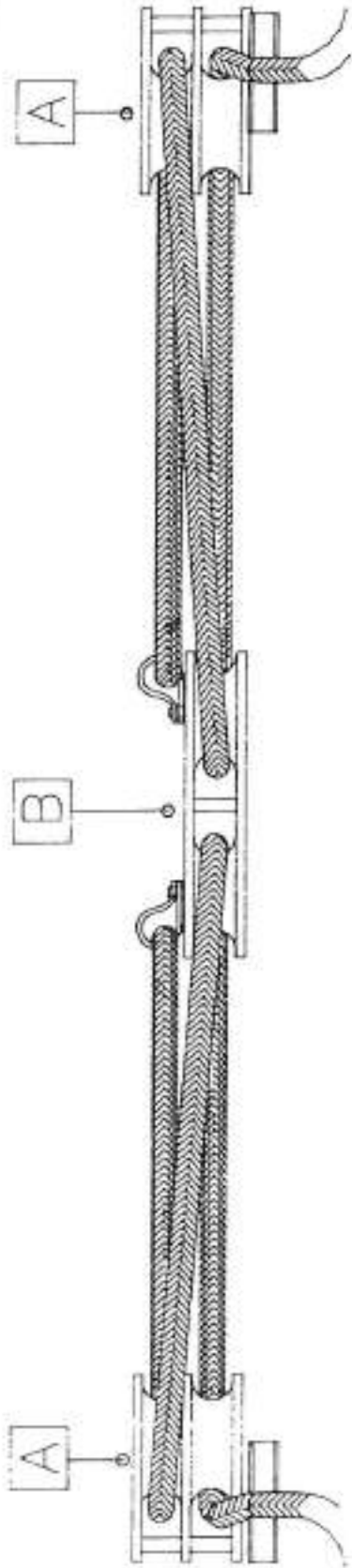

- [A] DOUBLE BLOCK WITH CAM CLEAT
SCHAEFER #74-56 (PORT)
SCHAEFER #74-57 (STB)

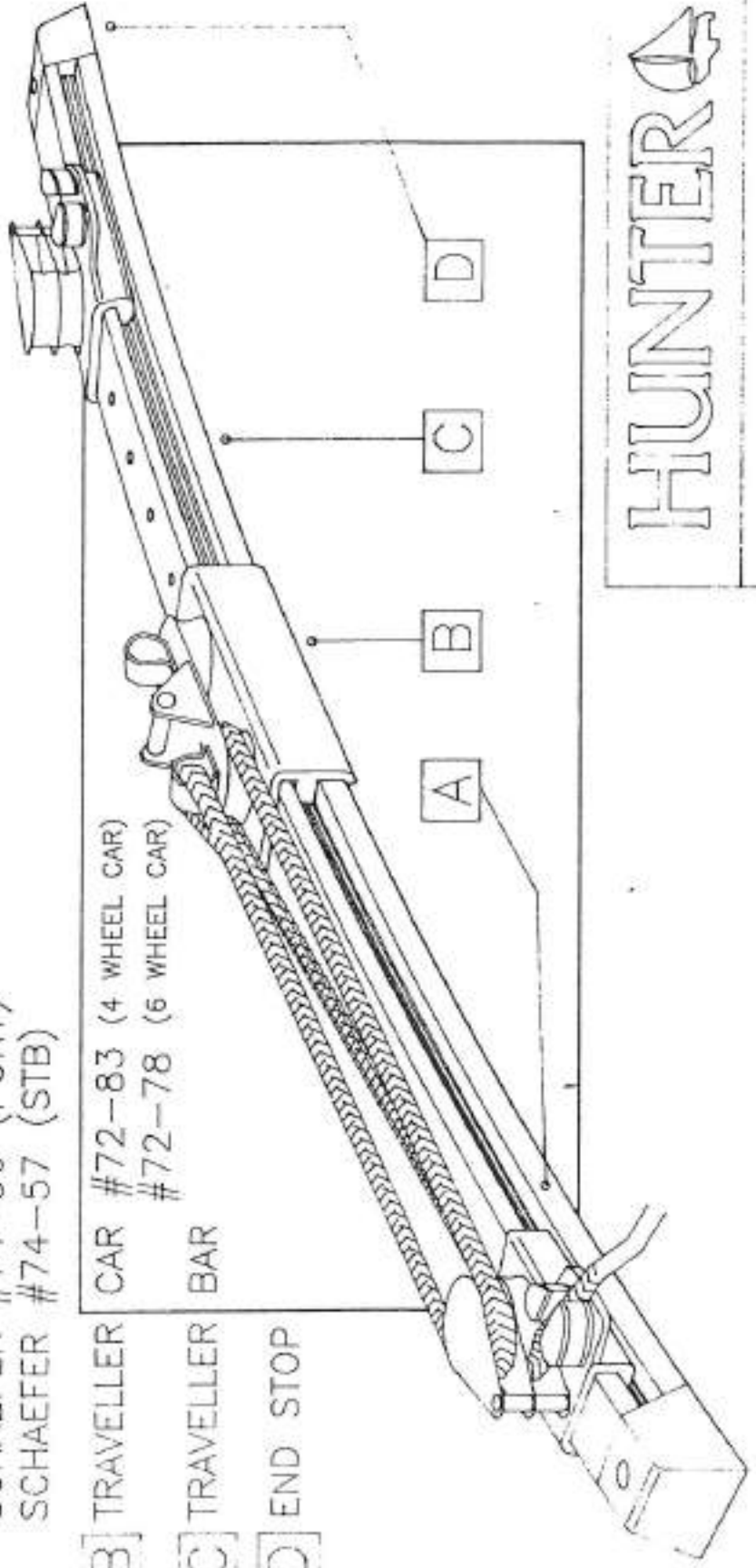

- [B] TRAVELLER CAR #72-83 (4 WHEEL CAR)
#72-78 (6 WHEEL CAR)
- [C] TRAVELLER BAR
- [D] END STOP

HUNTER

TRAVELLER DETAIL GENA2611

INSTALLATION

1. PLACE ALUMINUM RING ON SPAR
2. PLACE RUBBER MAST PARTNER ON SPAR W/ WEDGE DOWN
3. STEP MAST
4. ROTATE MAST TO ALIGN GOOSE NECK W/ CENTERLINE OF BOAT
5. ON DECK-TIGHTEN BOLTS IN ALUMINUM RING IN STAR PATTERN PROGRESSIVELY AROUND SPAR UNTIL TIGHT (THERE SHOULD BE A CONSISTANT DISTANCE BETWEEN ALUMINUM RING AND DECK WHEN BOLTS ARE TIGHT)
6. BELOW-DRILL 9/16" HOLES THROUGH MAST AND MAST STEP AT DIMPLES ON MAST STEP (ONE PORT, ONE STBD)
7. INSTALL 14 1/4" X 1/2" BOLT THROUGH HOLES AND TIGHTEN
8. ON DECK - CAULK AROUND RUBBER MAST PARTNER AND SPAR

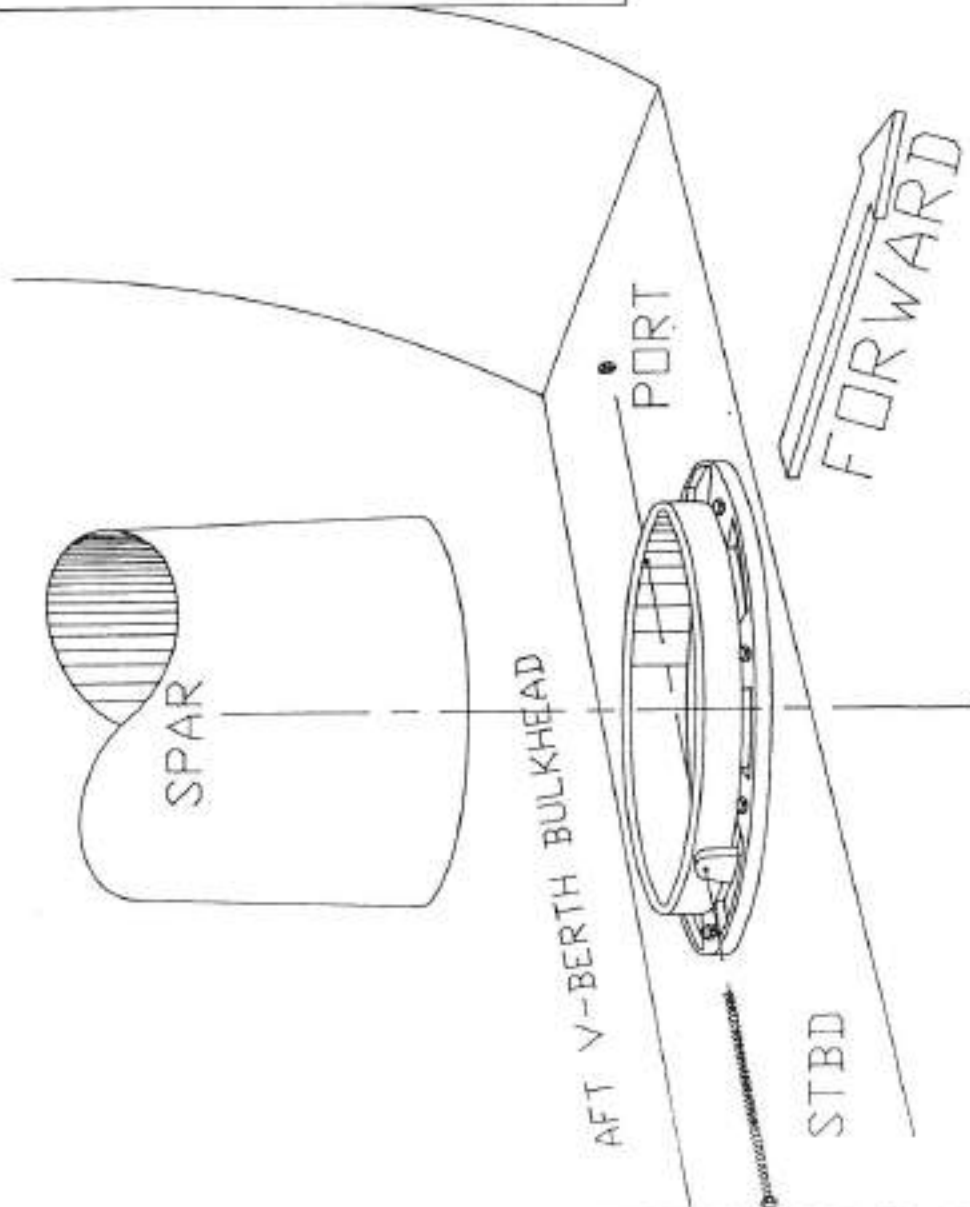

HUNTER

VISION 32 MAST INSTALLATION V32A2620

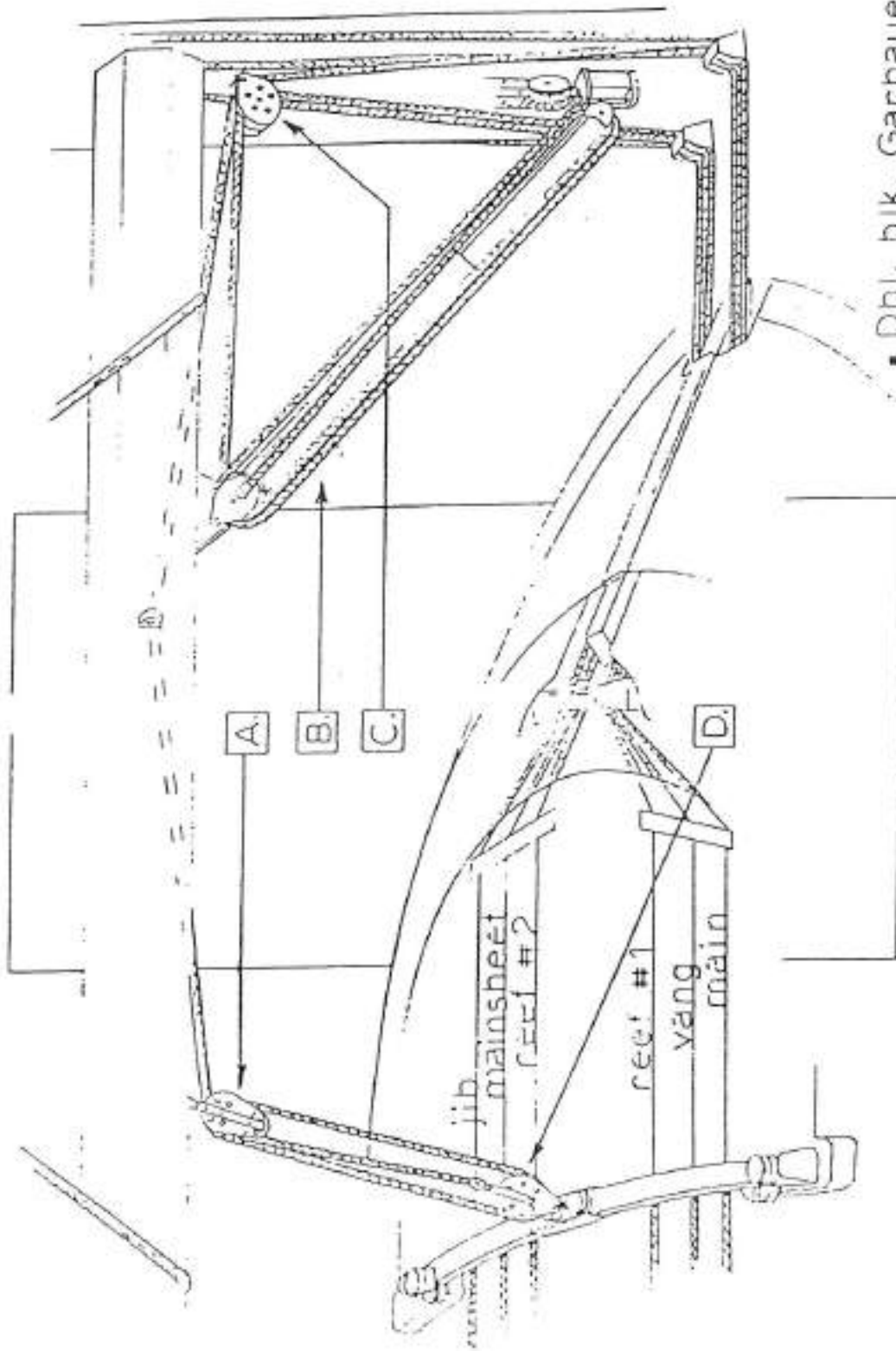

• Dbl. blk. Garhauer
see Isoreef System

A Fiddle block Schaefer #07-46

B Isovang

C Double blk. Sch. #05-23

D Single blk. w/ bucket Sch. #07-13

HUNTER

VISION 32 RUNNING RIGGING H32A261B

VISION 32 RIGGING SPECIFICATIONS

STANDING RIGGING

FITTINGS

<u>Description</u>	<u>Wire Size</u>	<u>Upper End</u>	<u>Lower End*</u>	<u>Overall Length</u>
Headstay	7/32 1x19	Marine eye	7-12-12	33'9 3/4"

- * "X-X-X" represents the tumbuckle size as follows:
Wire size - body size - pin diameter in 32nd's of an inch. Example"
7-12-12 is a diameter in the tumbuckle that accepts a 7/32" wire, has a
3/8", (12/32"), thread diameter in the body, and uses a 3/8", (12/32") pin.

RUNNING RIGGING

<u>Line</u>	<u>Size</u>	<u>Attachments</u>	<u>Overall Length</u>
Main Halyard	7/16"	Headboard shackle	115'
Jib Halyard	3/8"	Snapshackle	83'
Main Sheet	7/16"	Eye splice	56'
Jib Sheet	3/8"		35'
Traveller Control Lines	3/8"	Eye splice	19'
Lazy Jack	3/8"		50'
Lazy Jack Vinyl	3/16" 7x7	Two Thimbles	20'
Anchor Line	1/2"	Shackle	150'

All lines low stretch Dacron except anchor line which is nylon.

All rigging is supplied by SECO SOUTH.

HUNTER

VISION 32 DECK HARDWARE V32A2633

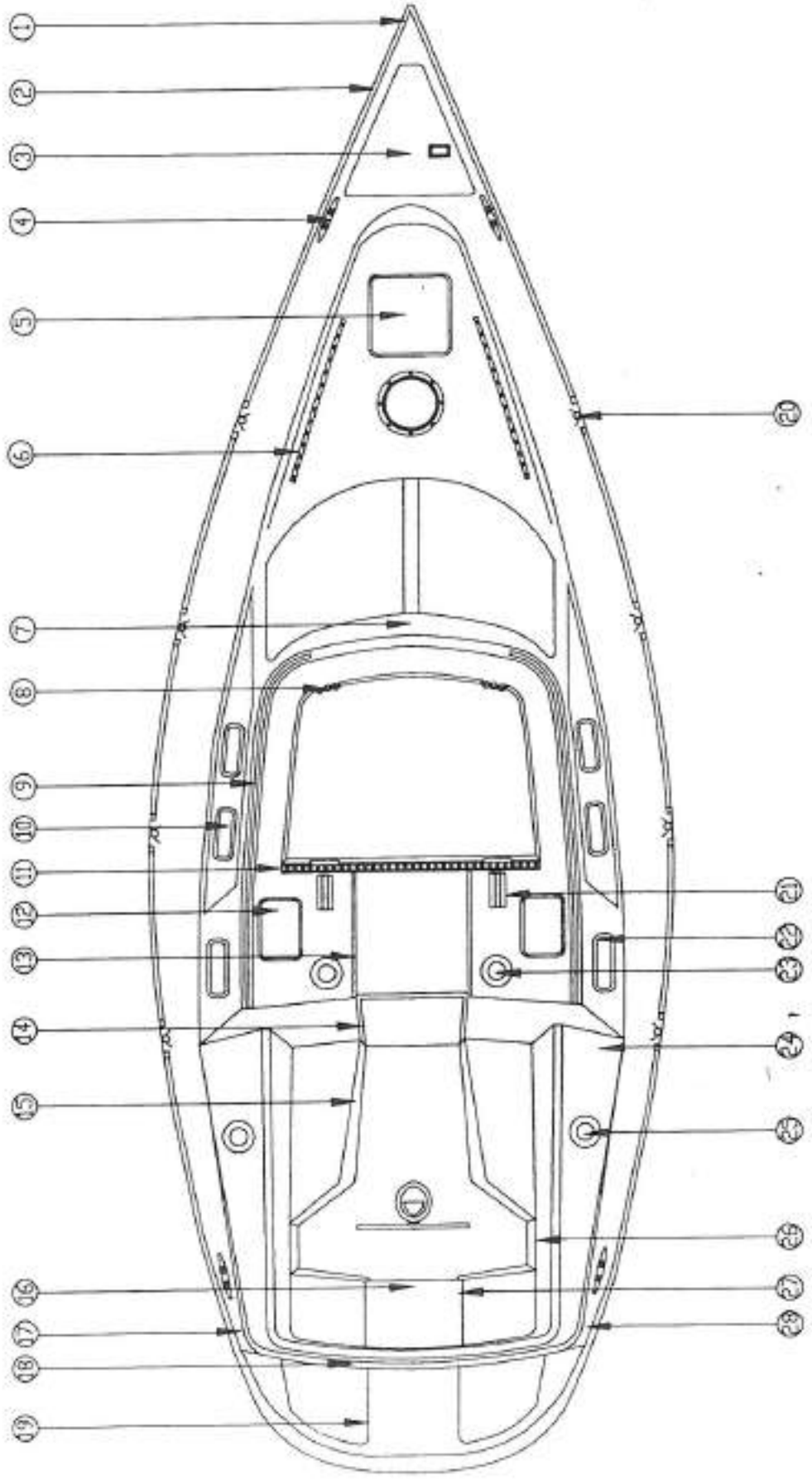

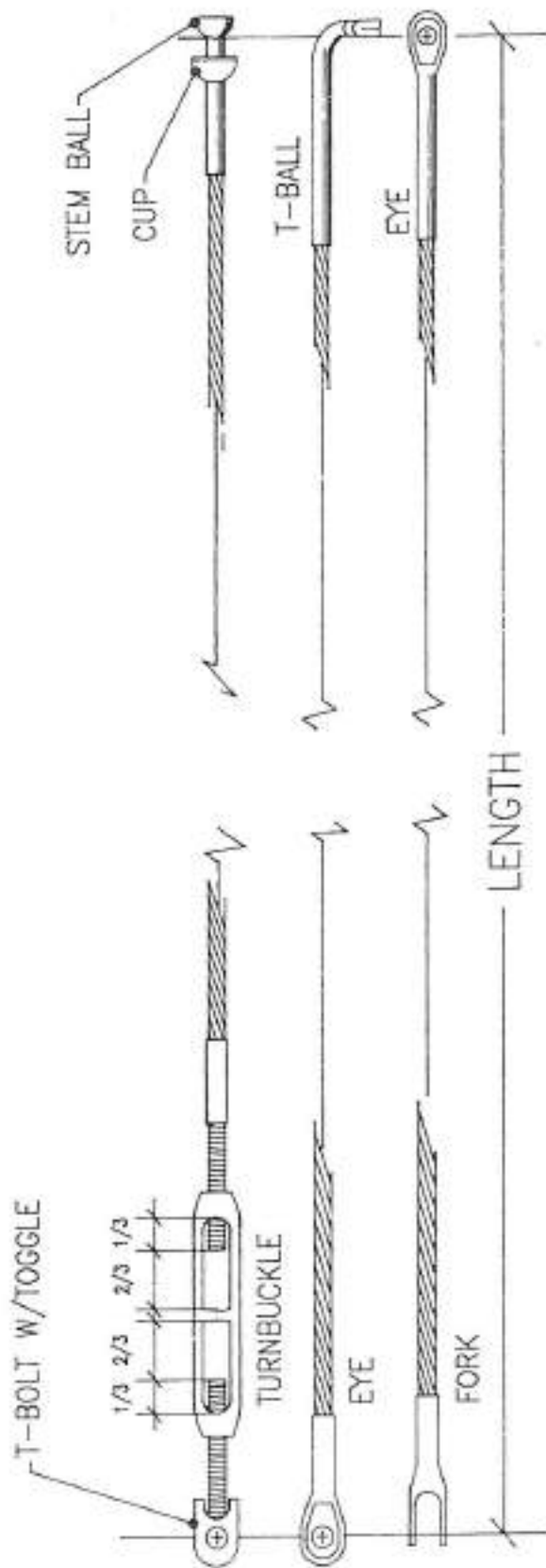

HUNTER

RIGGING LENGTHS GENA2605

MARINCO SHORE POWER CABLE SET

INSTRUCTION SHEET

WARNING - To minimize shock hazard, connect and disconnect cable as follows:

1. Turn off the boat's shore connection switch before connecting or disconnecting shore power cable.
2. Connect shore power cable at the boat first.
3. If polarity warning indicator is activated, immediately disconnect cable and have the fault corrected by a qualified electrician.
4. Disconnect shore-power cable at shore outlet first.
5. Close inlet cover tightly.

DO NOT ALTER SHORE-POWER CABLE CONNECTORS.

STORAGE

Your MARINCO shore power cable set is intended for use outdoors. To prolong the life of the set, store indoors when not in use.

MAINTENANCE

WARNING - To prevent electrocution, always disconnect from power source before performing maintenance.

General:

The metallic parts of your MARINCO cable set are made to resist corrosion. In salt water environment, life of the product can be increased by periodically wiping the exposed parts with fresh water, drying and spraying with a moisture repellent.

A soiled cable can be cleaned with grease cutting household detergent. A periodic application of vinyl protector will help both ends and cable maintain their original appearance.

In case of Salt Water Immersion:

Rinse plug end and/or connector end thoroughly in fresh water, shake or blow out excess water and allow to dry. Spray with a moisture repellent before re-use.

REPAIR

If either plug or connector end requires replacement (component or molded type), it can be replaced with the following MARINCO devices.

CABLE RATING	PLUG	COVER	CONNECTOR	COVER
30A-125V 2 pole, 3 wire	305CRP	102	305CRC	103R
50A-125V 2 pole, 3 wire	6361CR	7717	6360CR	7715CR
50A-125/250V 3 pole, 4 wire	6365CR	7717	6364CR	7715CR

HUNTER

VISION 32 LAZY JACK

- A Pad eye 2ea. on mast
- B D-shackle 2ea.
- C Block Schaefer 303-03 2ea.
- D Boom bale
- E Cleat on
- F 3/16 7X7 pvc coated wire 2ea.
- G 3/8 Samson braid

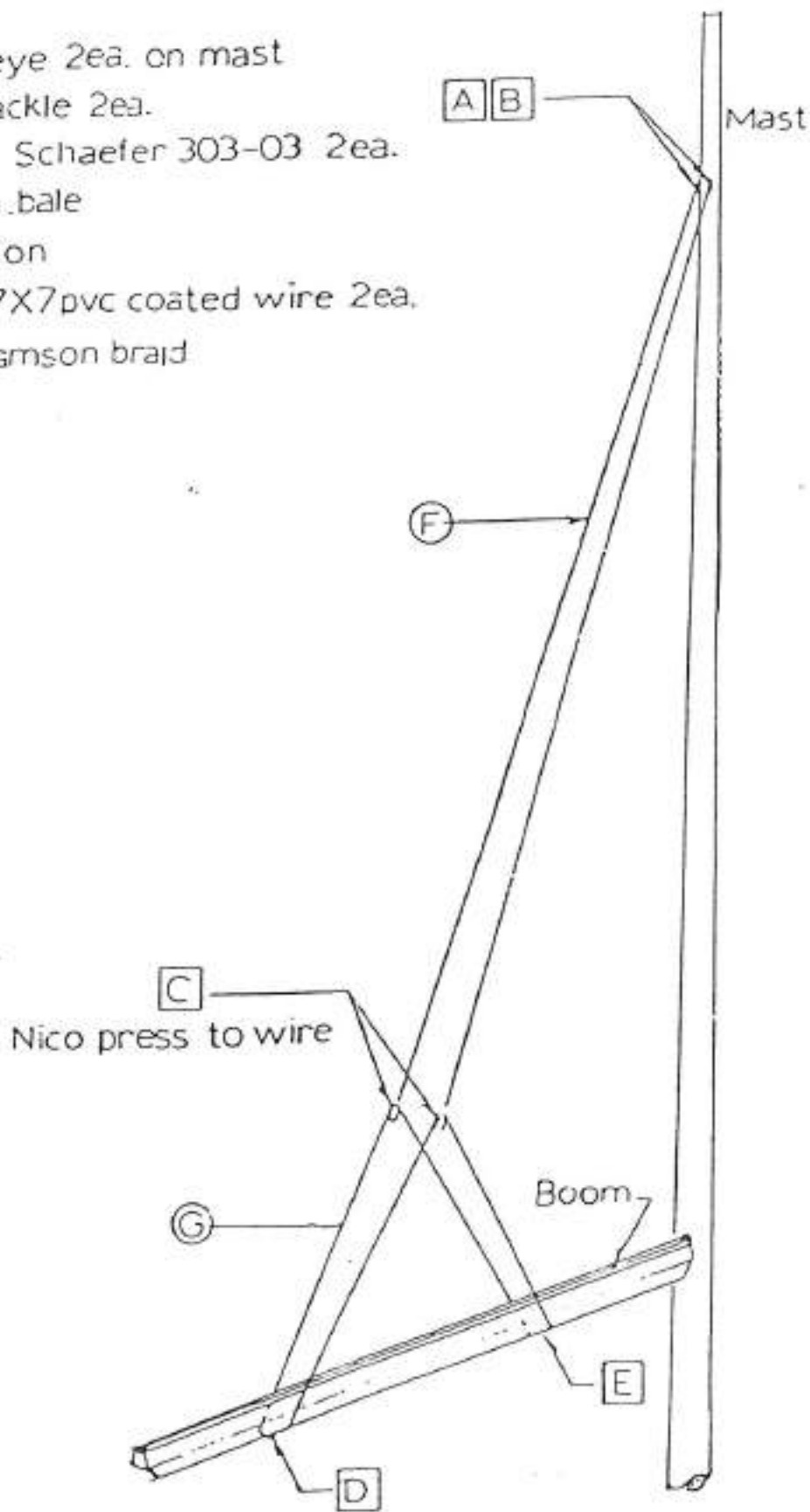

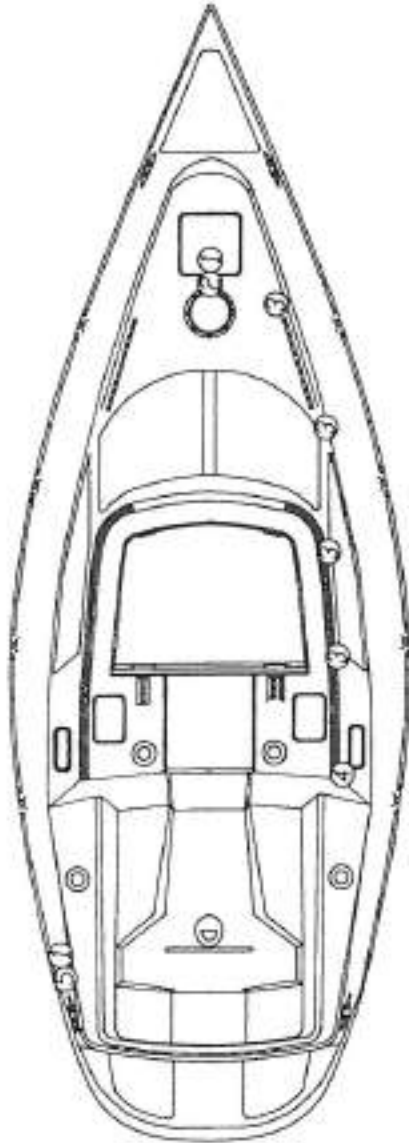
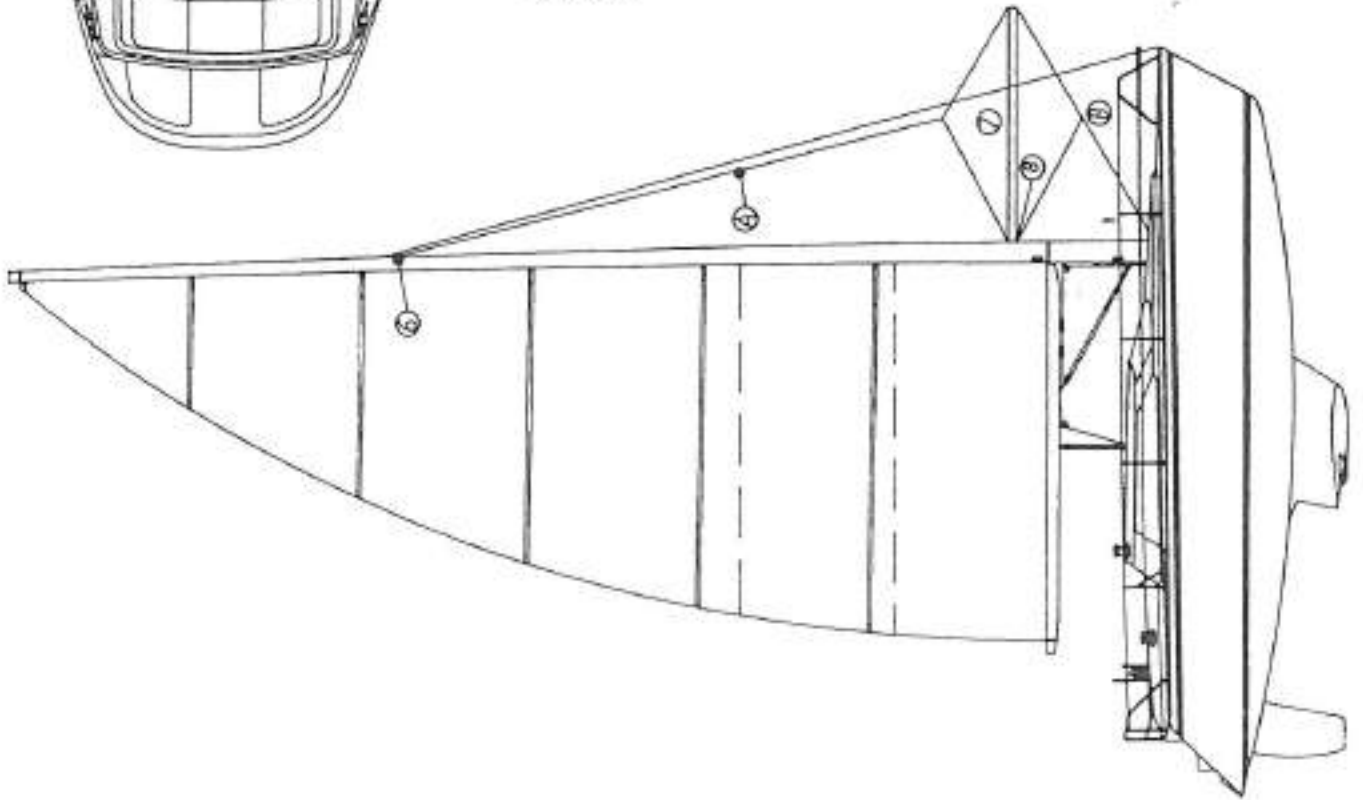

<u>ITEMS</u>		<u>LINES</u>	<u>LENGTH (FEET)</u>	<u>SNAPSACKLES</u>
A	SPINNAKER POLE TOPPING LIFT	3/8"	90'	7200-210
B	FOREGUY	3/8"	30'	7200-210
C	SPINNAKER SHEETS (TWD)	3/8"	64'	7210-220
D	SPINNAKER HALYARD	3/8"	90'	7210-220

DECK FITTINGS

- | | |
|-----------------------------------|---------------------|
| <u>ITEMS</u> | <u>MANUFACTURER</u> |
| 1 PAD EYE (2) | SCHAEFER 78-01 |
| 2 FOREGUY BLOCK | SCHAEFER 05-05 |
| 3 BULLSEYE (4) | NICRO FICO 615 |
| 4 CAM CLEAT | SCHAEFER 70-37 |
| 5 SPINNAKER SHEET BLOCKS (TWD) | SCHAEFER 501-15 |
| 6 TOPPING LIFT BLOCK | ISOMAT |
| 7 SPINNAKER POLE (10') W/BRIDLES | ISOMAT |
| 8 SPINNAKER POLE CAR WITH CONTROL | ISOMAT |

CLASS SPIN. MEASUREMENTS: SPL = 10'
 SHV = 18'
 LL = 32'-9"

NOTE:
 SPINNAKER POLE TOPPING LIFT BLOCK (6) IS 6' BELOW FORESTAY.
 SPINNAKER HALYARD EXIT IS 18' ABOVE FORESTAY.

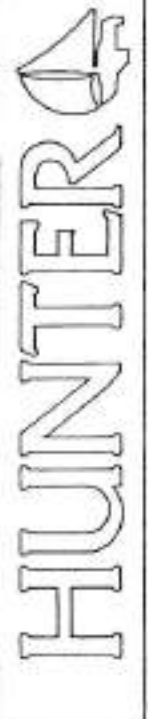

VISION 32 SPINNAKER PACKAGE V32A2634

HUNTER

VISION 32 SPINNAKER PACKAGE V32A2635

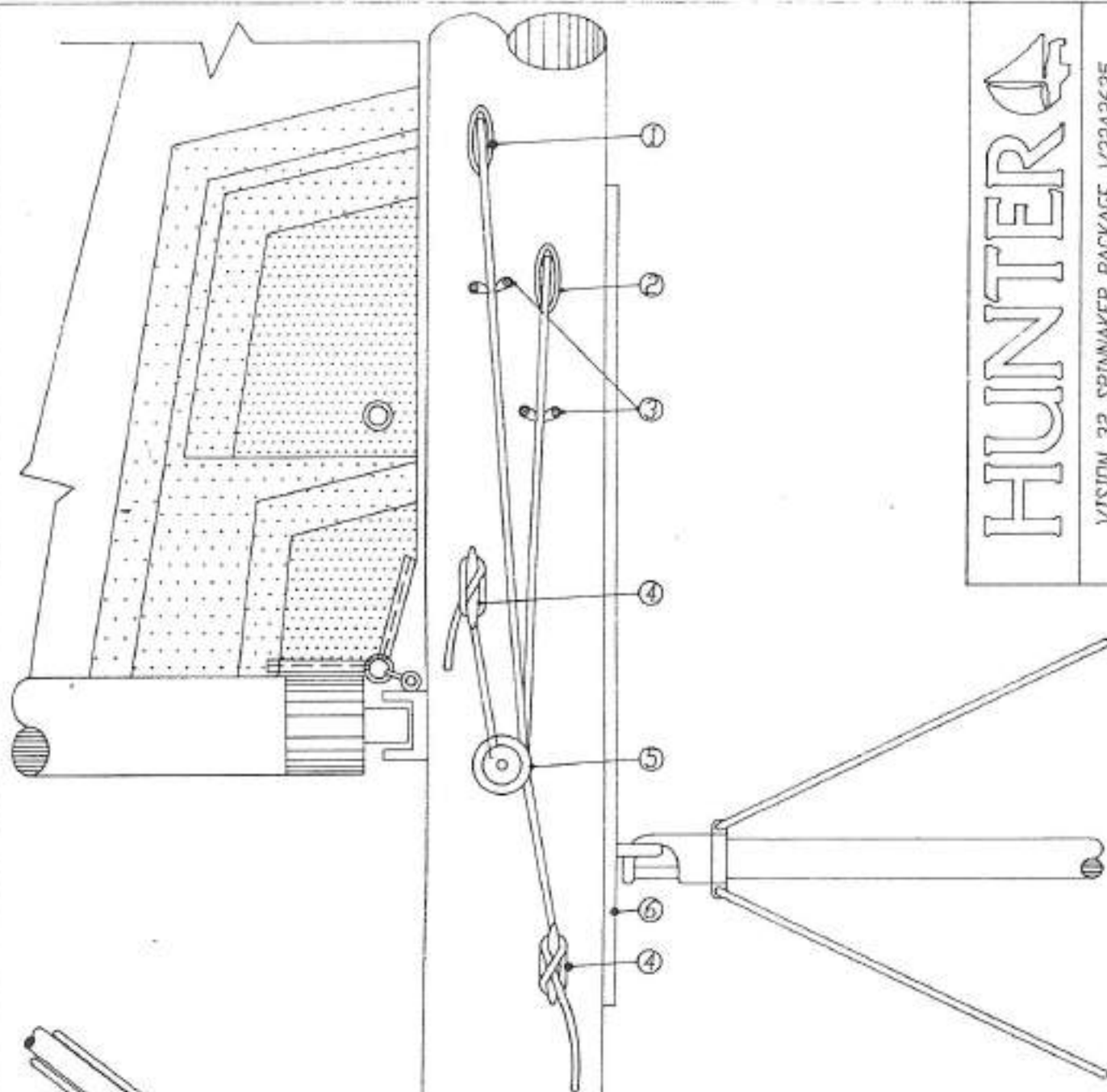

ITEM	MANUFACTURER
1 SPINNAKER EXIT	ISOMAT
2 POLE TOPPING LIFT EXIT	ISOMAT
3 CAM CLEAT (2)	HARKEN #150
MOUNTING BASE (2)	SCHAEFER #55-75
4 OPEN BASE CLEAT (2)	ISOMAT #T160
5 WINCH	BARIENT #8
6 SPINNAKER TRACK	SCHAEFER #40-44
SPINNAKER SLIDER	SCHAEFER #73-32
END STOP	SCHAEFER #74-35G

NOTE: TO MOUNT BARIENT #8 WINCH REMOVE CLEAT DIRECTLY ABOVE GOOSENECK. MOUNT WINCH SO THAT WINCH BASE COVERS THE HOLES FROM THE CLEAT.

L.O.A.	32'-0"
L.W.L.	28'-9"
BEAM	11'-4"
DRAFT	4'-3"
DISPLACEMENT	11,400 LBS.
BALLAST	4,500 LBS.
HEADROOM	6'-3"
E	16'-0"
J	8'-3"
P	43'-9"
I	33'-0"
MAST HEIGHT (From DWL)	53'-0"
SAIL AREA	
MAIN	431 SQ. FT.
100% FORETRI.	136 SQ.FT.
SAIL WEIGHTS	
MAIN (DACRON)	7 OZ.
LAPPER (DACRON)	7 OZ.

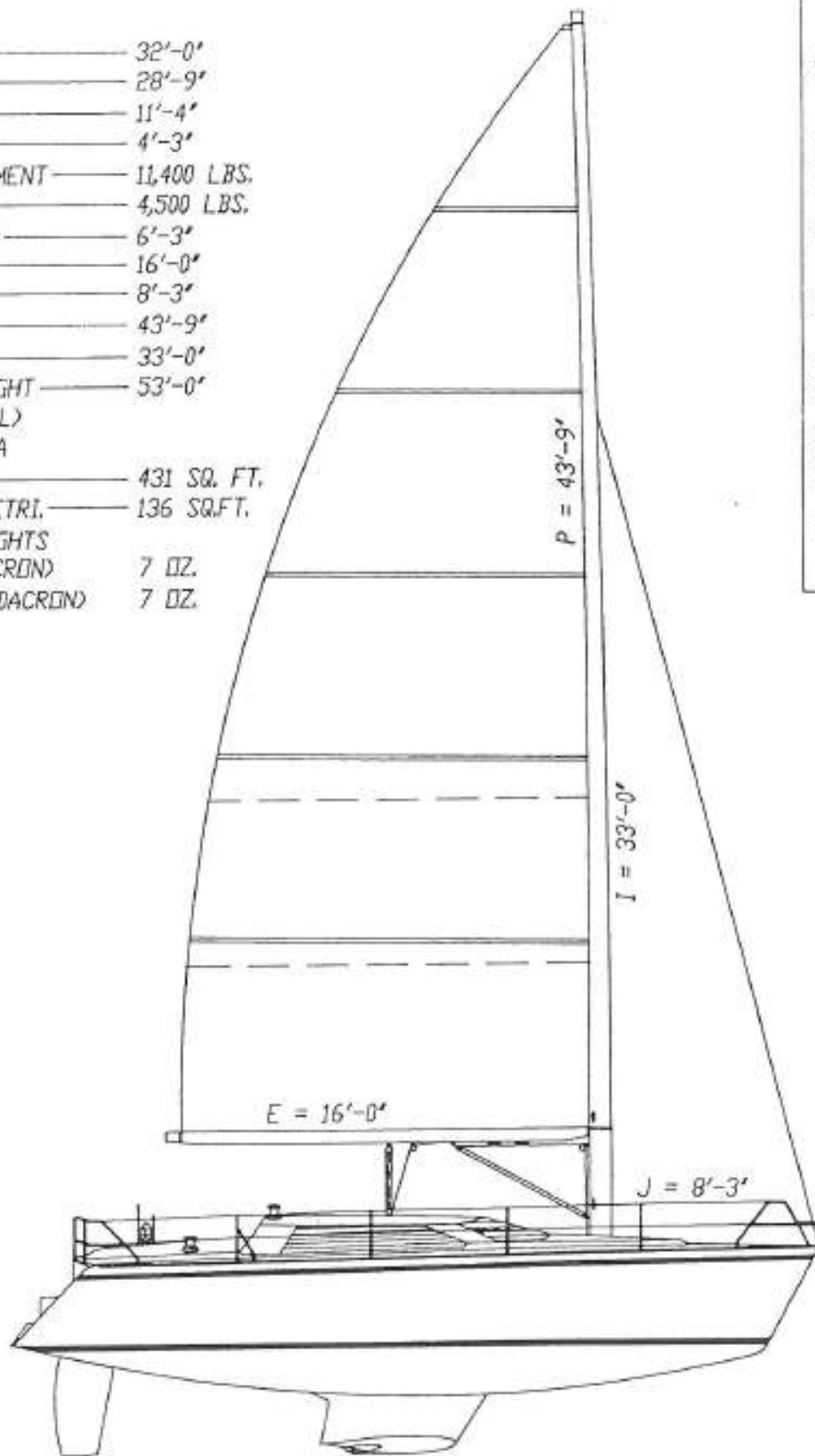

HUNTER

VISION 32 SAIL PLAN V32A2636

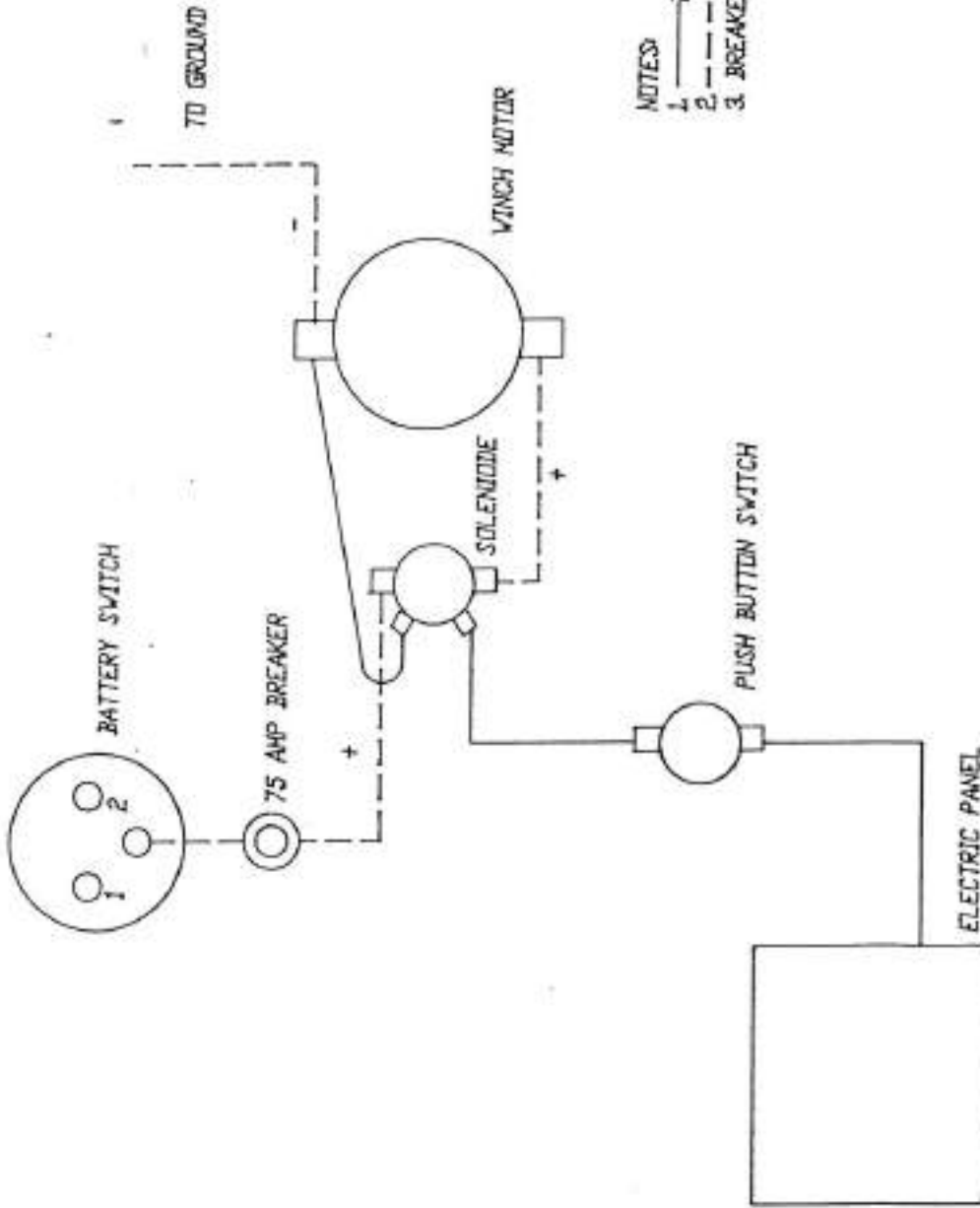

NOTES:

1. — 2 GA. WIRE
2. - - - 16 GA. WIRE
3. BREAKER IN ELEC. PANEL TO BE 5 AMP.

PROPRIETARY INFORMATION: This document discloses information for which HUNTER MADE CORP. has proprietary rights.	
<h1>HUNTER</h1>	
DRAWING TITLE: V32-36 WINCH WIRING DIA	
PAPER SIZE: A	DATE: 9-25-91
SCALE: 1=1	DRAWING NO.: HUNA1803
DESIGNER: LDM	CHECKED: N/A
DRAWN BY: N/A	APPROVED: N/A
DATE: 9-25-91	SCALE: NONE
HUNTER PART NO.	DRAWING NO.
N/A	HUNA1803
PLUT SCALE: 1=1	
DO NOT SCALE	
REVISIONS	
NO.	DATE
1	
2	
3	
4	
5	
6	
7	
8	
9	
10	
11	
12	
13	
14	
15	
16	
17	
18	
19	
20	
21	
22	
23	
24	
25	
26	
27	
28	
29	
30	
31	
32	
33	
34	
35	
36	
37	
38	
39	
40	
41	
42	
43	
44	
45	
46	
47	
48	
49	
50	
51	
52	
53	
54	
55	
56	
57	
58	
59	
60	
61	
62	
63	
64	
65	
66	
67	
68	
69	
70	
71	
72	
73	
74	
75	
76	
77	
78	
79	
80	
81	
82	
83	
84	
85	
86	
87	
88	
89	
90	
91	
92	
93	
94	
95	
96	
97	
98	
99	
100	

To Pull Back:

pull and rap curtain around self, then secure on snap cap **A**.

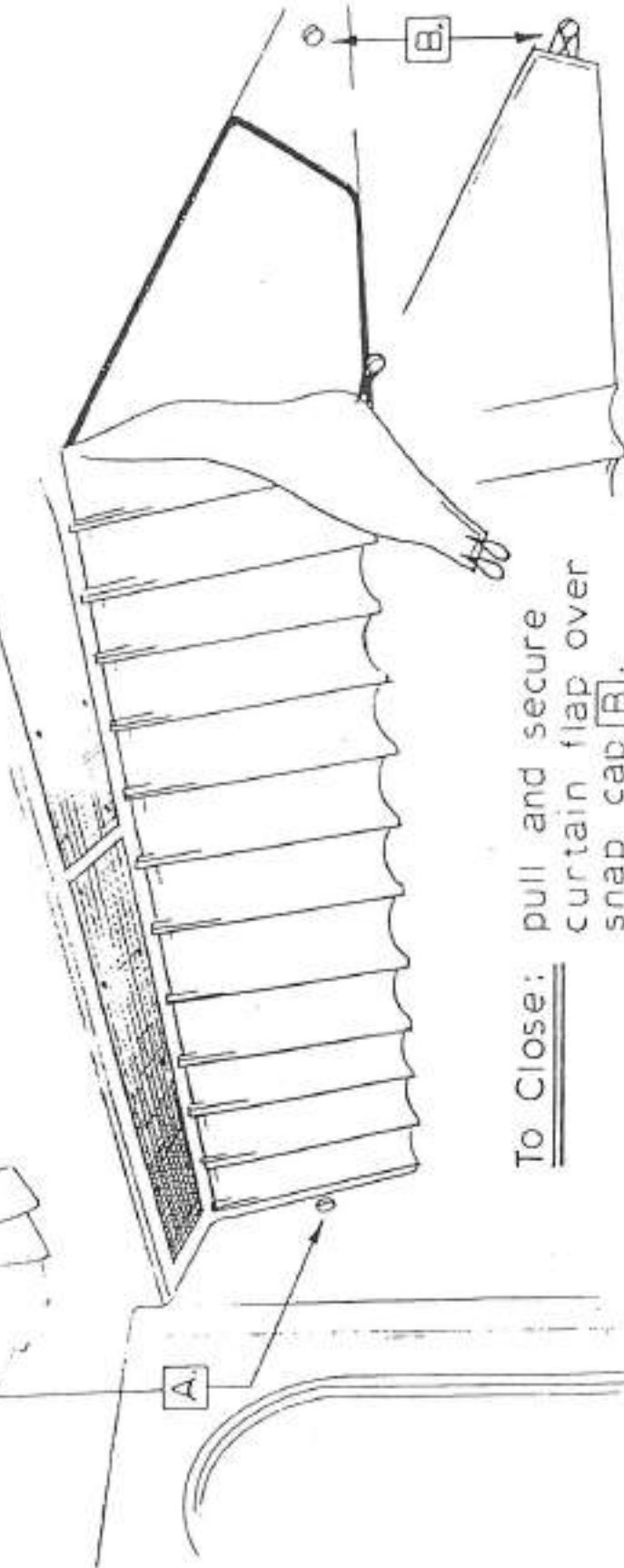
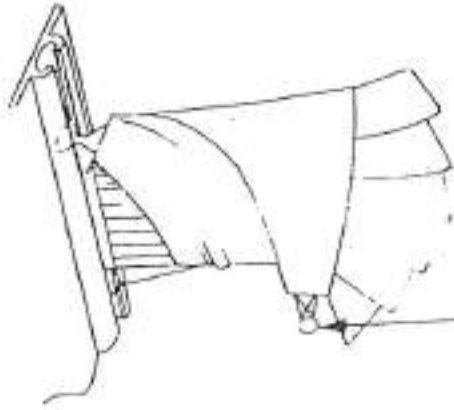

To Close: pull and secure curtain flap over snap cap **B**.

HUNTER

VISION 32 CURTAIN DETAIL H32A2619

Filler Cushion Storage

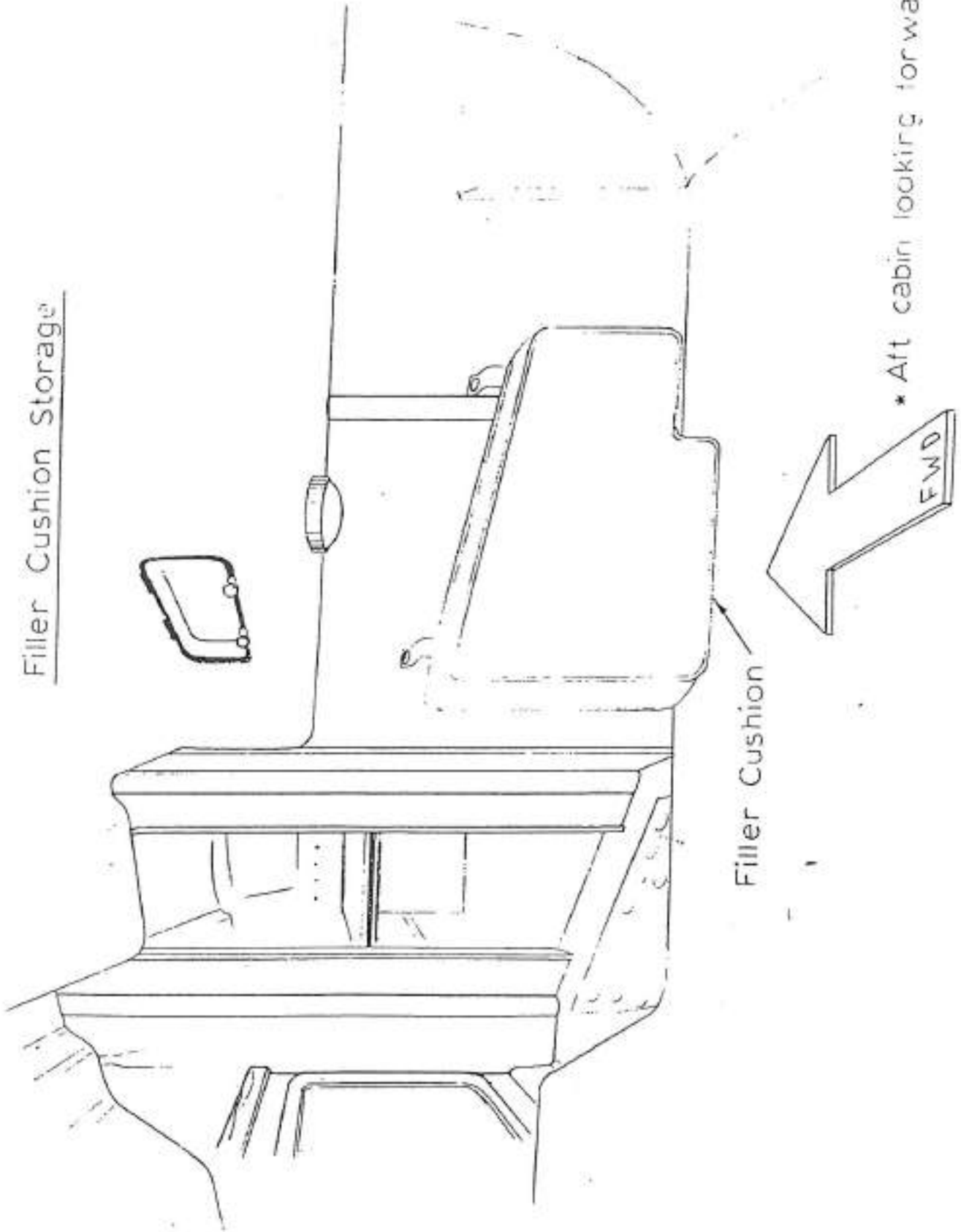

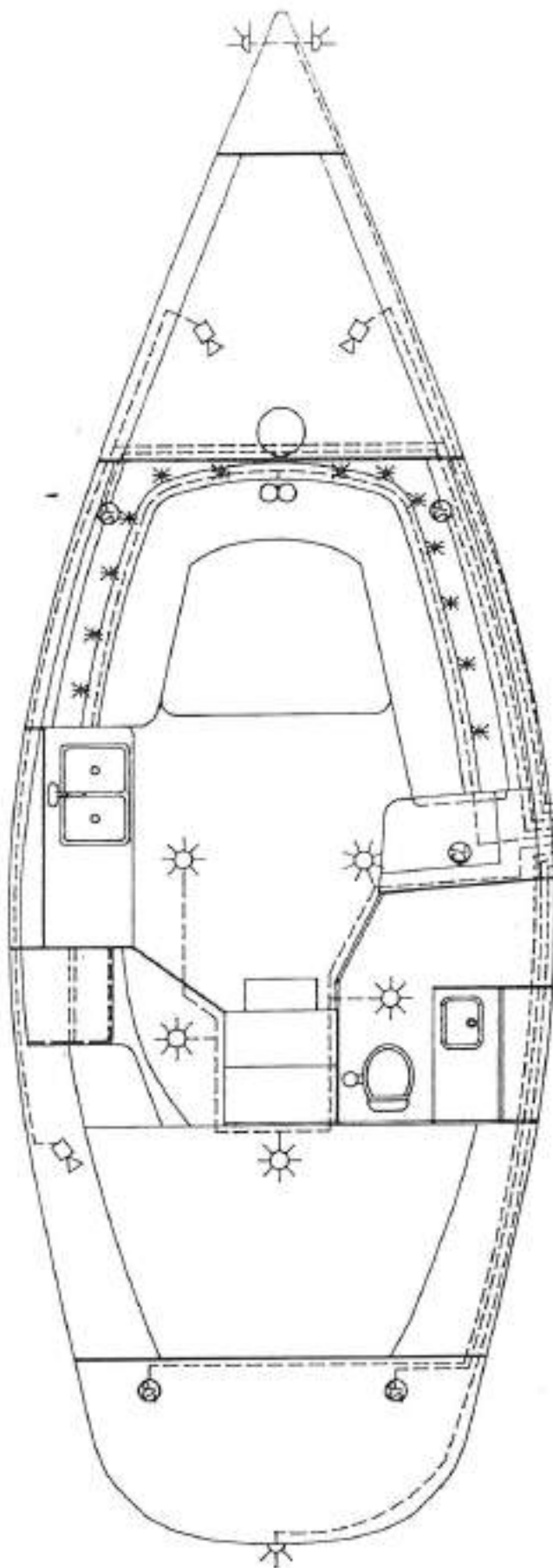

LEGEND

- ⊙ CHART LIGHT
- ⊖ DOUBLE LIGHT
- * STRIP LIGHTING
- ☀ DOME LIGHT
- ☼ SWIVEL LIGHT
- ⊕ STERN LIGHT
- ⚓ STBD. BOW LIGHT
- ⚓ PORT BOW LIGHT
- ⊙ SPEAKER

LINE TYPE

- 16 GAUGE WIRE

TO PANEL

NOTE:
 WIRES LEADING TO ALL INTERIOR LIGHTS ARE IN PAIRS OF 16 GAUGE BLACK AND BLUE.
 WIRES LEADING TO BOW AND STERN LIGHTS ARE IN PAIRS OF 16 GAUGE BLACK AND WHITE.
 WIRES LEADING TO STARBOARD SIDE SPEAKERS ARE IN PAIRS OF 16 GAUGE BLACK AND BROWN.
 WIRES LEADING TO PORT SIDE SPEAKERS ARE IN PAIRS OF 16 GAUGE BLACK AND YELLOW.

HUNTER

VISION 32 THRU HEADLINER ELECTRICAL SYSTEM V32AR629

VISION 32 LIGHT BULB SPECIFICATION

Your Vision 32 has 12 interior lights, three navigation lights and two lights on the mast. Of the interior lights 5 are dome lights, 3 are swivel lights, 2 clear tube lights, 1 double eyeball light and 1 light which is removable from its bracket and installed over the chart table.

LIGHT

REPLACEMENT BULB

INTERIOR

Dome	#1572 and Wagner #S8-1141
Swivel	#1831 and Wagner #S8-1073
Tube	Vista TAC15'-3-CL
· Eyeball	Jensen RT1057
Chart	Aqua Signal #90400282

EXTERIOR

Red bow	Osram 12V #6411, 24V #6429, Philips 12V #12866, 24V #13866
Green bow	Same as above.
Stern	Same as above.
Running	Perko 68 12V 20W
Anchor	Aqua Signal #90400200

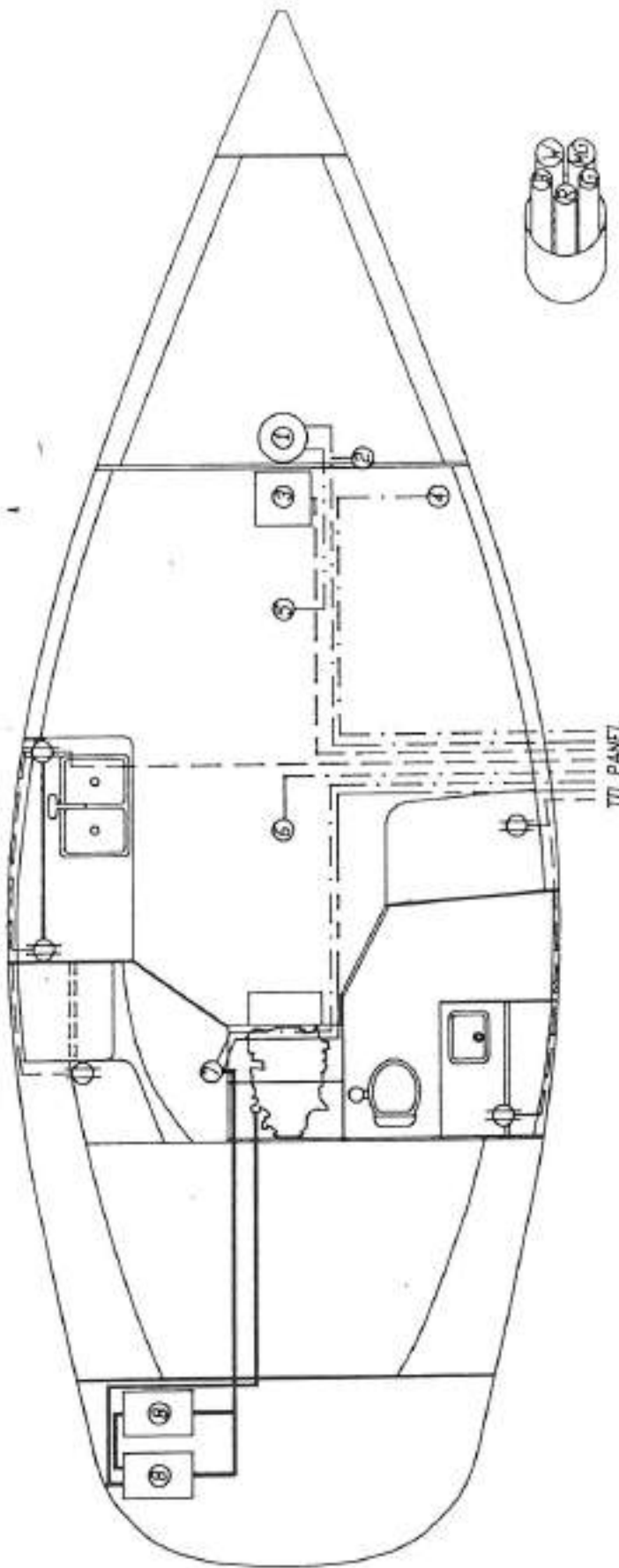

- LEGEND**
- ① MAST HEEL
 - ② BUZZ BAR
 - ③ WATER HEATER
 - ④ WATER PUMP
 - ⑤ GROUNDING PLATE
 - ⑥ BILGE PUMP
 - ⑦ SELECTOR SWITCH
 - ⑧ BATTERY
 - ⊕ RECEPTACLE

- LINE TYPES**
- _____ 1/0 BATTERY CABLE
 - #8 WIRE
 - 10 GAUGE WIRE
 - 12 GAUGE WIRE
 - 14/3 WIRE
 - MAST LIGHT HARNESS

SYMBOL	COLOR	GAUGE	APPLICATION
B	BLACK	16	GROUND
R	RED	16	ANCHOR
G	GREEN	16	STEERING
W	WHITE	COAX	VHF
MG	BLACK	8	MAST GROUND

HUNTER

VISION 32 PAN ELECTRICAL SYSTEM V32A2630

PUMPS, STRAINERS, FILTERS

COMPONENT

MANUFACTURER AND PART NUMBER

Bilge pump

Rule 800 or Mayfair 800

Waste pump

ITT Jabsco #142M

Water pump

ITT Jabsco Flo-Jet 4405-143-C

Water strainer

ITT Jabsco 364000-1000

Engine strainer

1/2" Perko 493-004 PLB

Fuel filter

Racor 110

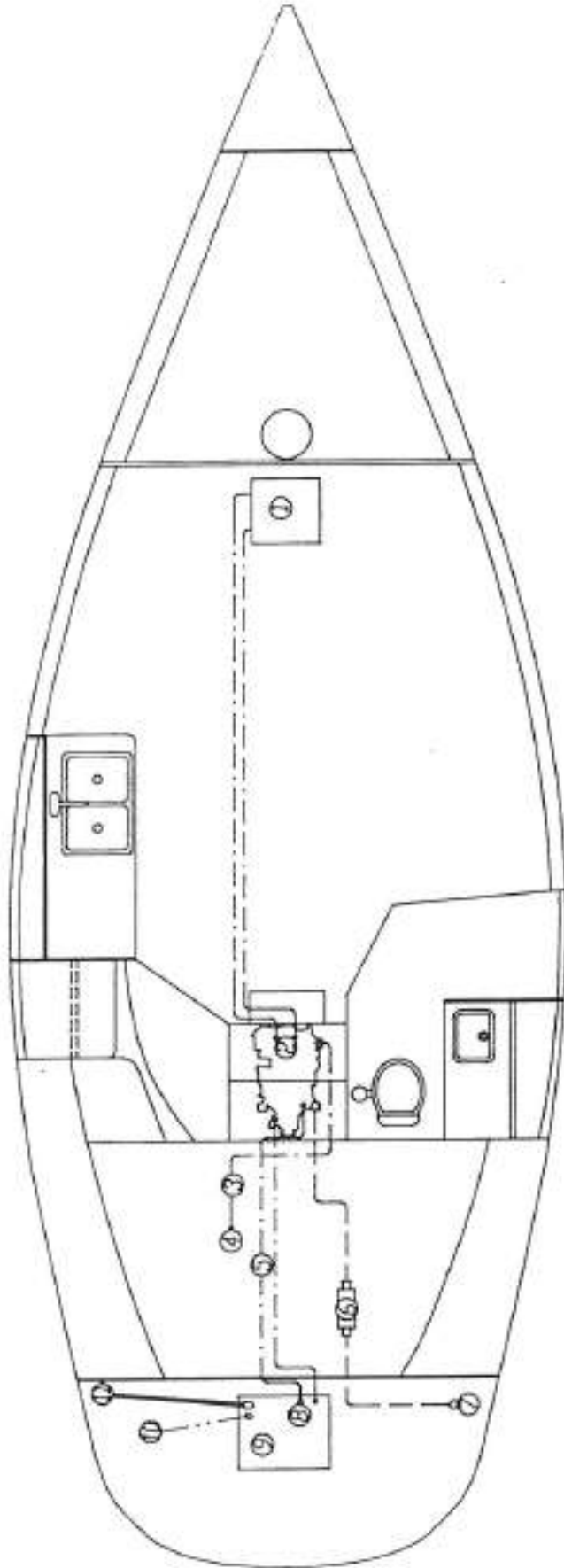

LEGEND

- ① WATER HEATER
- ② HEAT EXCHANGER
- ③ ENGINE INTAKE WATER FILTER
- ④ ENGINE WATER INTAKE, THRU HULL
- ⑤ FUEL FILTER
- ⑥ MUFFLER
- ⑦ ENGINE EXHAUST, THRU HULL
- ⑧ FUEL VALVE
- ⑨ FUEL TANK
- ⑩ FUEL TANK VENT, THRU COCKPIT
- ⑪ FUEL FILL, THRU DECK

LINE TYPES

- 1/4" FUEL HOSE
- 3/4" SHIELDFLEX
- 5/8" SHIELDFLEX
- 1 1/2" SHIELDFLEX
- 2" EXHAUST HOSE

HUNTER

VISION 32 ENGINE SYSTEM V32A2624

- [A] BILGE PUMP
- [B] AUTO FLOAT SWITCH
- [C] HOSE CUFF
- [D] HOSE CLAMP
- [E] CHECK VALVE
- [F] SHIELDVAC HOSE
- [G] WOOD BACKING BLOCK
- [H] THRU-HULL FITTING

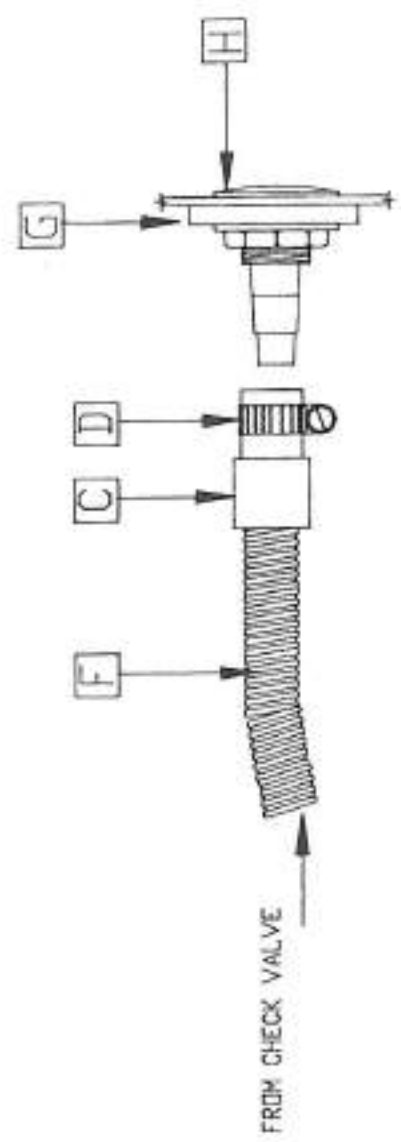
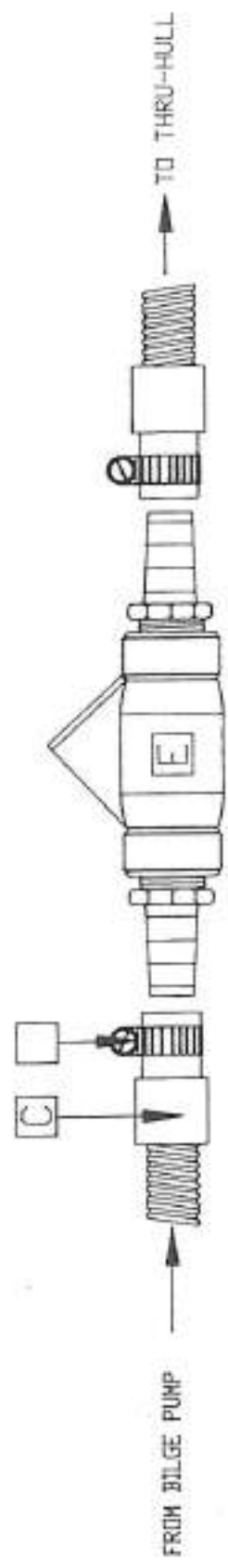
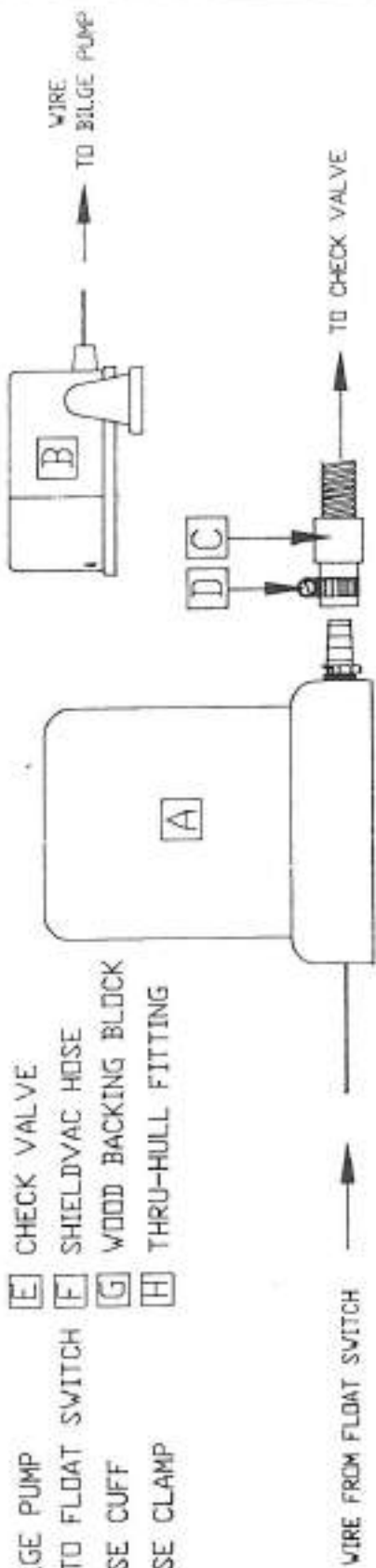

HUNTER

AUTO BILGE PUMP LAYOUT GENA2613

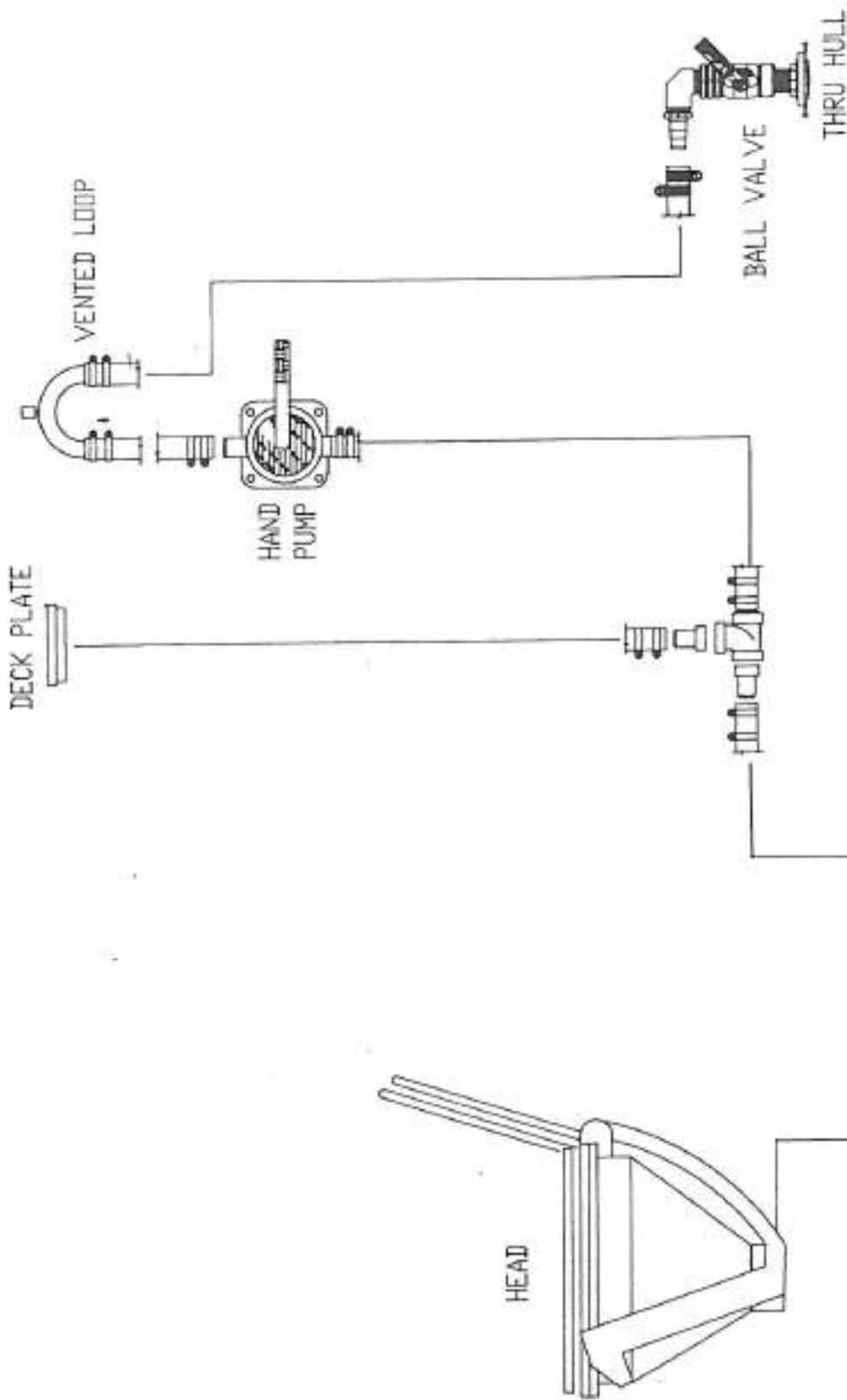

HUNTER

HEAD PLUMBING DIA. GENA2620

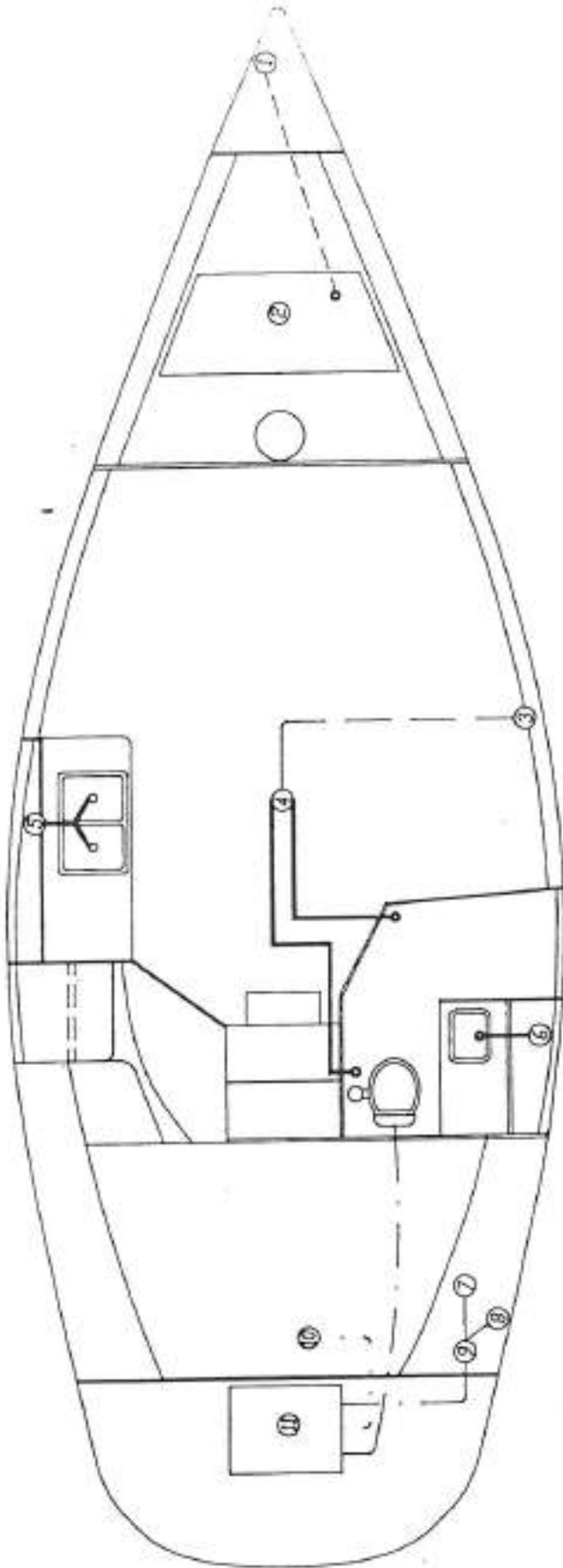

LEGEND

- ① WATER TANK OVERFLOW, THRU HULL
- ② WATER TANK
- ③ BILGE PUMP OUT, THRU HULL
- ④ BILGE PUMP
- ⑤ GALLEY DRAIN, THRU HULL
- ⑥ VANITY DRAIN, THRU HULL
- ⑦ WASTE TANK PUMP OUT, THRU HULL
- ⑧ WASTE TANK PUMP OUT STATION
- ⑨ WASTE TANK HAND PUMP
- ⑩ WASTE TANK VENT, THRU COCKPIT
- ⑪ WASTE TANK

LINE TYPES

- 3/4" SHIELDVAC
- 1" SHIELDVAC
- 1 1/4" SHIELDVAC
- 1 1/2" SHIELDVAC

HUNTER

VISION 32 WASTE WATER SYSTEM V32A76P6

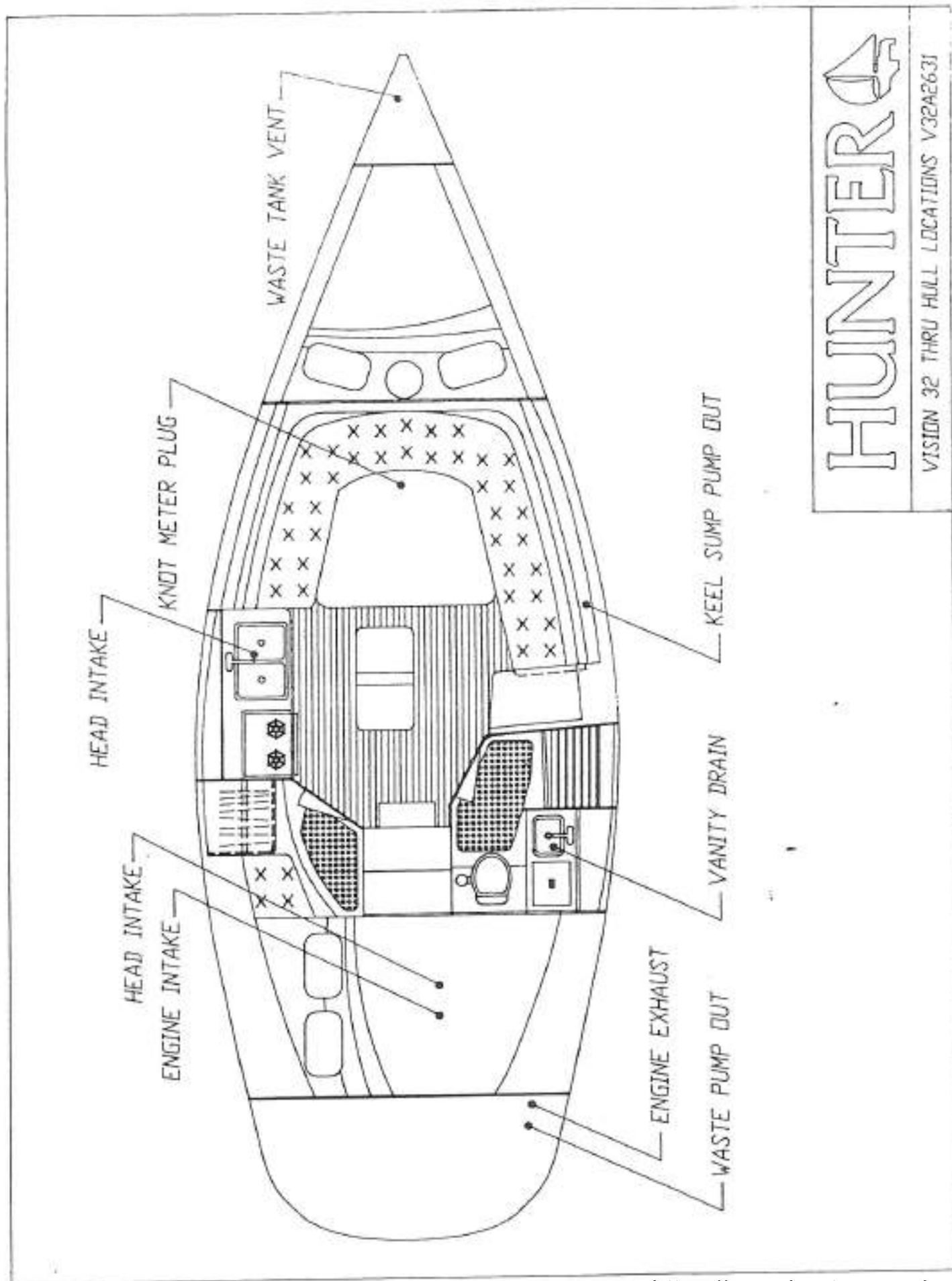

HUNTER

VISION 32 THRU HULL LOCATIONS V32A263J

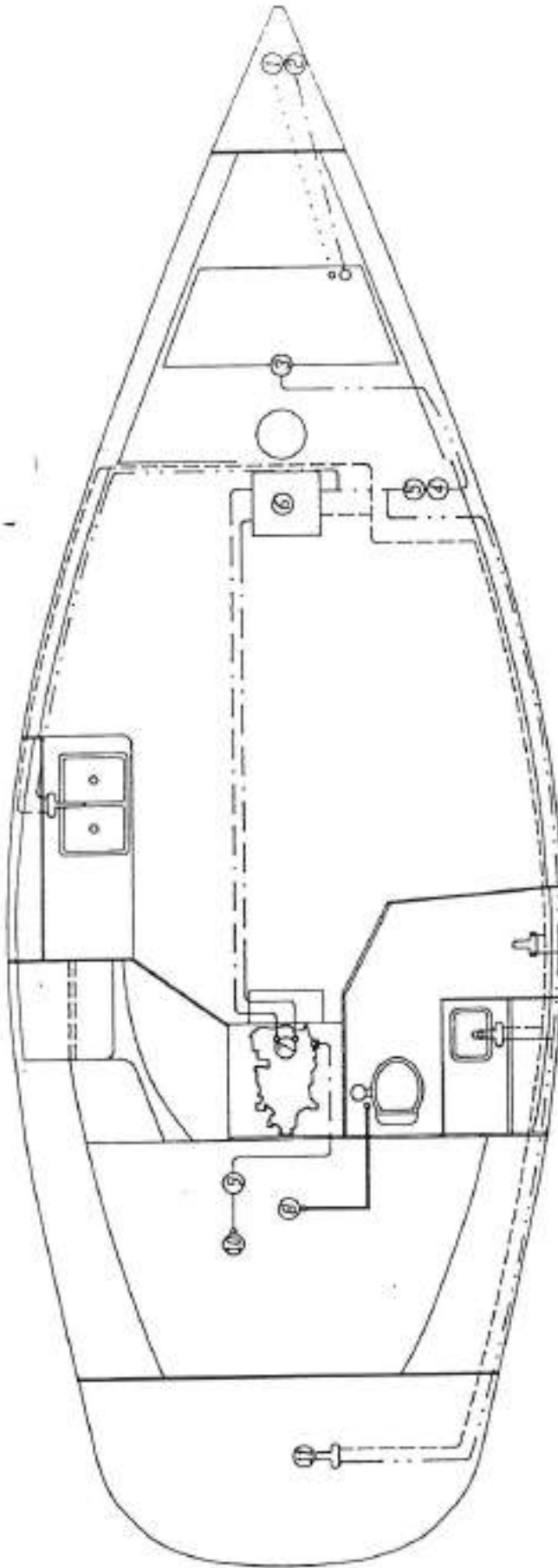

LEGEND

- ① WATER TANK VENT
- ② WATER TANK FILL
- ③ WATER SHUT OFF VALVE
- ④ WATER FILTER
- ⑤ WATER PUMP
- ⑥ WATER HEATER
- ⑦ HEAT EXCHANGER
- ⑧ HEAD WATER INTAKE
- ⑨ ENGINE WATER FILTER
- ⑩ ENGINE WATER INTAKE
- ⑪ COCKPIT SHOWER

LINE TYPES

- 1/2" POLY COLD
- 1/2" POLY HOT
- 5/8" SHIELDFLEX
- 3/4" WATER HOSE
- 3/4" SHIELDVAC
- 1 1/2" SHIELDVAC

HUNTER

VISION 32 SUPPLY WATER SYSTEM V32A2625

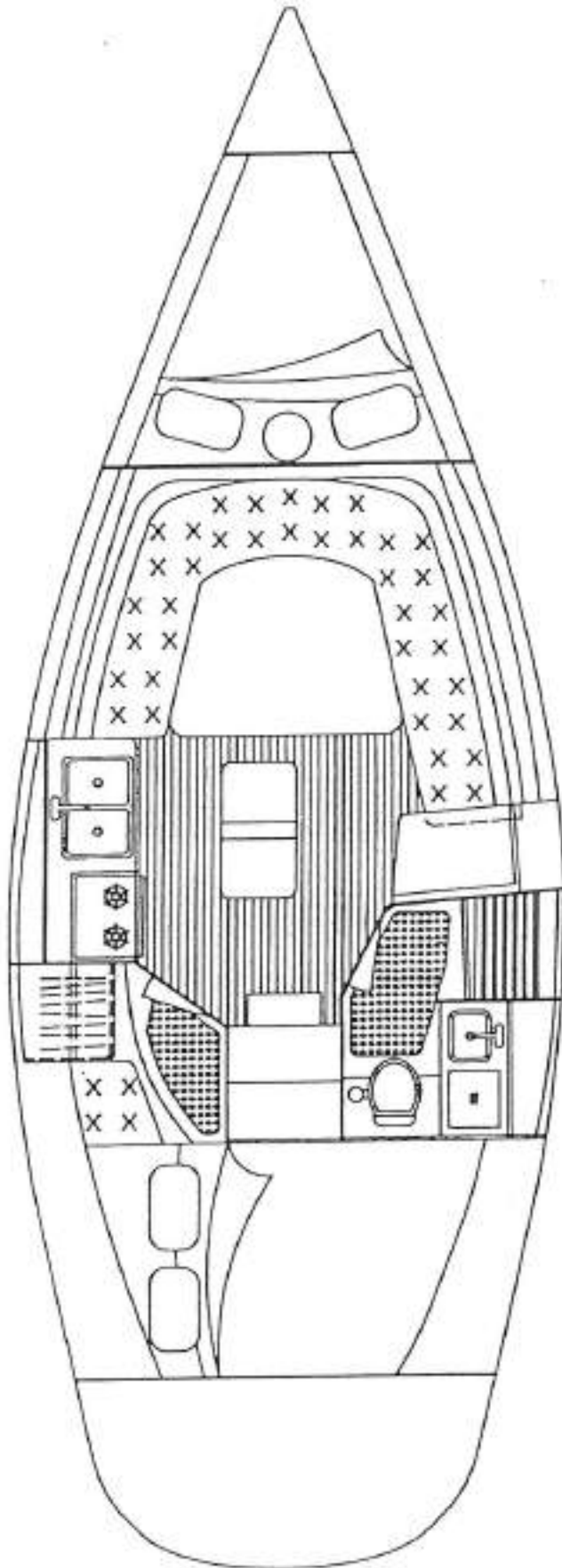

HUNTER

VISION 32 INTERIOR LAYOUT V32A2632

INSTRUCTIONS FOR PREPARATION FOR BOTTOM PAINTING

WARNING!

Do not use any sanding, sandblasting or other abrasive preparation of the bottom as this will void your hull blistering warranty. More information on the warranty is available in this owner's manual.

BOTTOM PAINTING

Choose a bottom paint system that suits the environment in your area.

Follow the procedure recommended by the manufacturer of the paint, while making sure not to void the Hunter Hull Blistering Warranty. The procedure for preparing for and painting the bottom varies between paint manufacturers, but should always include dewaxing, etching and sometimes priming of the surface.

The rudder should always be bottom painted using a white bottom paint, to avoid heat build-up in the rudder, which colored paints can contribute to, when the boat is on land. For further instructions on preparation of the rudder, see the instructions sheet from *Foss Foam, Inc.* under the General Information heading within this manual.

TEAK CARE

Teak wood is a high quality, extremely durable wood with a high oil content. In order to help you protect the original beauty of your teak interior, we have sealed the beauty of your interior with a 3 to 4 coat finish system of high quality Seafin Teak Oil, manufactured by *Dalys* (wood finishing products). This material is a penetrating oil that dries to a low sheen to seal and protect the wood from moisture and weathering. It creates a durable, non-slip surface to repel water and resist wear. It won't chip, peel or blister. It reduces work and maintenance cost because it is easy to maintain and repair. With proper maintenance it will out live urethane varnish on interior and even exterior surfaces. (floor, bulkheads, trim wood & furniture).

MAINTENANCE

When oiled surfaces require renewing, simply wipe the surface area free of loose dirt, dust or other contaminants. Dampen a cloth with the Seafin Teak Oil and wipe on. Let stand for 5-15 minutes then polish dry.

REPAIRS

When wood work is damaged from scrapes or abrasions that go into or thru the finish, take the following steps:

1. Take 180 to 220 grit wet/dry sand paper to smooth out rough spots.
2. Wipe clean of dust and dirt with a clean rag. Note - before applying oil wood surface must be dry.
3. Wipe or brush on oil, allow to penetrate 5-15 minutes while surface is still wet.
4. Sand until smooth with a 400A wet/dry sandpaper.
5. Wipe dry with a clean rag. Allow 8-12 hours drying time.
6. Apply 2nd coat, and repeat above procedure.

This process may be repeated as many times as needed to bring damaged area back up to its original finish. If you have trouble with getting the same sheen, you may apply with a completely dampened/rung out cloth, a very light coat over this area and/or whole surface area to get an even sheen.

DALYS
3525 STONEMAN NORTH
SEATTLE, WA 98103
(206) 633-4200

MAINTENANCE

Engine, Transmission and Drivetrain

ENGINE: Follow the fuel and lubrication requirements in the Engine Manual. Check the engine oil level before and after operation and use quality motor oil (refer to Engine Manual). Be certain the proper amount of oil is in the crankcase at all times.

Engine alignment: The engine should be aligned by experienced marine service personnel. Final alignment should be done after launching, with all normal gear aboard. A description of the procedure follows:

The coupling flanges must come together evenly at all points, a feeler gauge is used to check the gap. If adjustment is necessary, the engine is tilted up or down and/or side to side until the flanges meet equally. Severe vibration will result from misalignment and can cause strut bearing and shaft damage.

Alignment should be checked again after several weeks of use.

(Refer to this manual's alignment drawing)

Any questions or problems concerning the engine, please contact our distributor, Mack Boring at (201) 964-0700.

TRANSMISSION: Follow the lubrication requirements of the Engine Manual. The oil level should be checked immediately after operation.

DRIVETRAIN: The shaft log (stuffing box) should be inspected periodically.

The stuffing box is held to the shaft log tube by a rubber tube secured by hose clamps. The clamps should be tight and no water should leak from this location. A slight drip from the stuffing box at the shaft exit is necessary (four drops a minute) and is normal.

To adjust, loosen the lock nut, tighten gland nut one-quarter turn, and retighten lock nut. If excessive water flow persists after adjustment, replace the packing and then adjust as above.

Steering

Refer to the manufacturer's instructions for maintaining pedestal steering system. Cables should routinely be inspected for proper tension. Lightly oil all cables.

Electrical Systems

The electrical system is a 12-volt, negative ground installation. The owner should weekly inspect battery(ies), terminals and cables for signs of corrosion, cracks, and electrolyte leakage. Battery terminals are to be kept clean and greased. Refer to separate instructions on batteries, wiring diagram, and electronics.

MAINTENANCE

Plumbing Systems

All pumps should be checked frequently to insure proper operation. **This is an especially important regular maintenance item since proper functioning of a pump could save your vessel from serious damage in the future.**

Inspect all hoses for chafing and dry rot. See that hose clamps are tight. Check that the pump impeller area is clean and free of obstructions.

Inspect electrical wiring for corrosion. Make sure float switches move freely and are making an electrical connection. Refer to Engine Manual.

The owner should become familiar with the layout of the water and waste systems by walking through the boat with the diagrams provided in this manual. It is especially important that the owner knows all thru-hull valve locations and inspects for leaks frequently. Refer to plumbing diagrams in Spec & Tech section.

General Thru-hull List (*varies from boat to boat-see diagrams in Spec & Tech Info.*)

- 1) Engine cooling system
- 2) Galley sink
- 3) Head sink
- 4) Head toilet (water intake)
- 5) Holding tank discharge
- 6) Scupper drains

Fuel System

The owner should inspect the condition of fuel lines for cracks or leaks. A primary source of fuel-related problems is water in the system. The owner should seek out only well maintained fueling facilities and make sure fuel fill caps are tightly secured after filling. Check and maintain fuel filters periodically. Refer to your Engine Manual for additional information.

General Care

CLEANING FIBERGLASS SURFACES: Fiberglass surfaces should be cleaned regularly. Normal accumulations of surface dirt can be removed simply by occasional rinsings with water. If your boat is operated in salt water, more frequent rinsing will be required. To remove stubborn dirt, grease or oil, use a mild detergent and a soft brush. Rinse with clean fresh water.

It is also a good idea to wax the fiberglass once or twice a year to maintain a deep , glossy appearance. Your local marine supply should be able to provide an appropriate wax.

Sail Care: Sunlight is a sail's worst enemy, so cover the sails when they are not in use. An ultraviolet guard, fitted down the leech of a roller headsail, will protect the exposed part from the weathering effect of the sun and from dirt and grit. Mildew, which discolors, is prevented by storing sails dry and by hand-washing twice a season.

MAINTENANCE

Sail care continued.

Check all sails regularly for chafe, particularly where they chafe on deck fittings or rigging, at reef points, batten sleeves and the foot of the headsail. Sail batten pockets should be inspected on a regular basis.

To stow the mainsail, start at the leech and flake it on to the boom, left and right, in about 18-in. (46-cm) folds, while pulling the leech aft. Secure with a sail tie and continue to the luff. Lash to the boom with sail ties or shock cord.

The headsail, neatly rolled and fastened, can be temporarily stowed along the lifelines. To stow below, flake it into a length; 1. then roll from luff to leech, 2. Take care not to crease the leech. Pack in a clearly marked bag.

Fabric Care

If wet, prop cushions vertically to promote airflow around each cushion. Cushions can be cleaned by most dry cleaners. Dry clean **only**.

Winch Maintenance

Follow the maintenance instructions prescribed by the winch manufacturer. We recommend a minimum of an annual cleaning and light greasing.

General Hardware Maintenance

Check all fittings regularly to be sure screws are tight. Occasionally lubricate (use silicone lubricants) all moving parts on such fittings as blocks, turnbuckles and cam cleats, as well as the locking pins of snatch blocks, track slides, spinnaker poles, etc. Inspect cleats and fairleads for roughness and smooth with fine grained emery paper if necessary. Also, replace any missing or damaged cotter pins in turnbuckles and shackles, and either tape them or use protective covers manufactured for that purpose.

MAINTENANCE

Electrolysis and Galvanic Protection

Salt water allows electric current to flow from anodic to cathodic material. Any two metals from two components, and their relative positions in the galvanic rating table, will determine which loses material (the anode) and which remains largely undisturbed (the cathode). The rate of wear is determined by the distance apart on the galvanic table of two metals. Thus a sacrificial zinc anode is often fitted to the underwater area of a boat to attract any destructive currents away from bronze or steel propeller shafts, for example.

It is not enough to know that your boat does not suffer from electrolysis: a newcomer in the adjacent marina berth may start a too-friendly association with metal components on it. An easy place to fit an anode is on the propeller shaft, or covering the propeller nut. The anode should not be painted because this will only defeat the purpose.

To prevent electrolysis in sea water, the difference between the voltage of two adjacent metals should not exceed 0.20V. Zinc and carbon steel, for example, used together, risk corrosion, while lead and active stainless steel are compatible. Metals with a high voltage corrode faster and need a larger area to diffuse the electro-chemical reaction.

MAINTENANCE

Alignment Procedure

1. Separate the coupling, move the shaft end back to clear the pilot in the center.
2. Establish the shaft in the center of the shaft log by raising the shaft until it touches the top of the log - note position - lower the shaft until it touches bottom of the log - note position - repeat sidewise and locate shaft in the center; block shaft in this position, using a block of wood under the shaft packing gland.
3. Now, adjust the engine mounts to allow the pilot on the coupling halves to slip together without moving shaft up, down, or sideways.
4. Adjust the engine mounts as necessary until a 0.004" feeler gauge will not enter anywhere along the edge of the flange between the faces.
5. Tighten the locks on the adjustable mounts.
6. Re-check coupling with feeler, re-adjust if necessary.
7. Check stuffing box (allow to drip slightly).

STEP 2

USE FEELER GAUGE TO CHECK COUPLING GAP. THE TOLERANCE SHOULD BE .004". MAKE SURE TO CHECK ALL THE WAY AROUND THE COUPLING.



NOTE: CHECK COUPLING GAP WITHOUT COUPLING BOLTS IN PLACE.

STEP 1

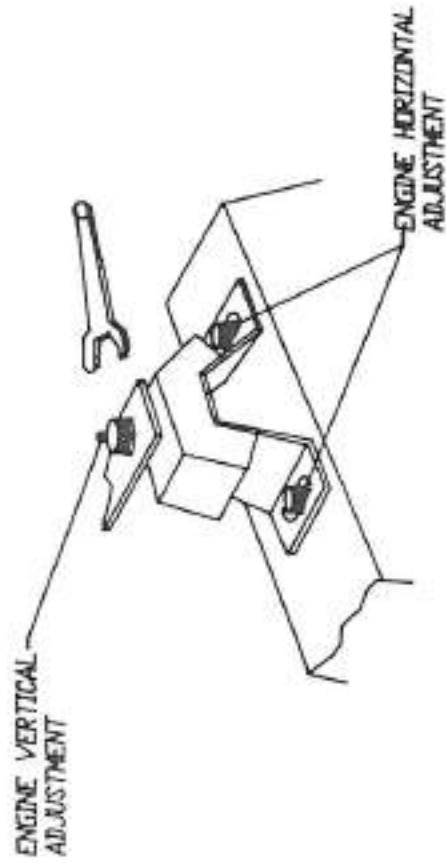

HUNTER

ALIGNMENT DIAGRAM GEN2619A



4400 - 126th AVENUE NORTH
CLEARWATER, FLORIDA
34622
AREA CODE (813) 577-0478

FOSS FORM, INC. // POLYURETHANE FORM

YOUR FOSS FIBERGLASS AND URETHANE RUDDER

Foss Foam Inc. has been producing sailboat rudders for over twenty five years for most major boat companies. The fiberglass blade with it's rigid urethane core has proven to be an extremely strong dependable rudder.

The near neutral bouyancy of your rudder helps the performance of your boat by reducing total weight, as well as reducing the moment of inertia in the stern. Near neutral bouyancy also is helpful should the rudder ever need to be removed for steering system repairs. The boat does not need to be hauled out of the water to remove the rudder.

Tough fiberglass and urethane plastic used in the construction of your rudder is nearly indestructable. The urethane core is composed of a strong rigid closed cell urethane. Water, diessel, solvents or marine borers will not damage your rudder blade, even if the glass coating has been damaged.

The edge seam should not be ground flush unless you re-glass the seam. If it is ground flush without re-glassing it will cause it to seperate.

When you paint your rudder the first time, particular attention should be paid to the paint manufacturer's instructions for preparing the surface. Solvent washing is not enough. The rudder must be sanded heavily to remove a heavy coating of mold release. We recommend white paint be used. White is a popular color as it is easy to see weeds and other debris which can catch on your rudder.

Cosmetic surface repairs may be performed by cleaning, drying and roughing up the damaged area and applying Marine bondo or any similar filler with a putty knife. Should a small blister appear, it may be filled with resin or cut away and repaired. Once the patch has dried, it may be sanded smooth and painted directly with bottom paint or any coating you desire.

We do not recommend the use of dark colors on your rudder, as they generate heat when the boat is out of the water in the sun. Since the rudder is made of cellular material this heat can cause dimentional changes and cosmetic damage. If the rudder is painted with a dark color it should be shielded from the sun with a white wrapping when the boat is out of the water. The rudder Warranty excludes damage caused by heat.

You should make periodic inspections of your rudder and look for possible damage from grounding or electrolysis. Slight bends or shaft erosion often are not noticed until the shaft fails in heavy sea conditions.

Should you have any questions about your rudder, feel free to call us at (813)577-0478

To properly maintain the moving parts in the top of the pedestal, it is necessary to remove the compass and its cylinder. For proper alignment when re-installing the compass, we recommend placing three or four lengths of tape on the pedestal and compass as shown below. Slit the tape when removing compass, align the strips of tape when re-installing the compass for visual realignment. Your compass **MUST** then be checked out for accuracy. Lubrication of needle bearings should be done by squeezing Edson Fig 827 Teflon Lubricant into the holes located on top of the bearing housings inside the pedestal bowl. Spin the wheel when squeezing the lubricant in to make sure the entire bearing is serviced. Winch grease or water pump grease can be used as an alternative, but don't let the bearings run dry. Do not over grease as it will run onto the brake pads. Oil the chain with #30 weight motor oil. Do **NOT** grease chain as it does not penetrate the links.

Inspect the condition of the wire, tension of the wire and lightly oil Edson recommends placing about five layers of "Kleenex" on the palm of your hand, squirt oil on the tissues and lightly oil the wire. This will lubricate the strands but will also "flag" a broken or hooked strand by tearing off a small section of tissue. If you do have a wire break, replace the wire immediately. See Edson Fig 775 Wire and Chain Replacement Kits. (Caution: Wire splinters can cause painful cuts.) Replace the wire after 5 years. If still good, keep the old wire on board as a spare.

STEERING WIRE TENSION

A top quality roller chain to wire steering system can be kept in "as new" sensitivity by keeping the wire at a correct tension. To check for proper wire tension, lock the wheel in position by using the pedestal brake, or by tying off the wheel. Cable tension is best when you cannot

move the quadrant or drive wheel by hand with the wheel locked in place. Over tightening will greatly reduce the sensitivity of the system.

It must be emphasized that all on board must be familiar with the care and operation of the Steering System and engine controls. One person must be assigned the job of maintenance and must be thoroughly familiar with the operation and intent of all the equipment. If at any time your Steering System makes strange noises or reacts differently than it has previously, you must find the causes immediately and correct the problem.

Screws, nuts, bolts, as well as clevis and cotter pins that are part of the steering system, engine controls or pedestal accessories, must be checked regularly for tightness and wear. Failure to inspect all steering parts, engine controls and pedestal accessories may cause loss of control or failure of the engine or steering system. *All boats must have an emergency tiller or its equivalent and all on board must be familiar with its location and operation. An emergency tiller drill is just as important as a man-overboard drill and must be regularly conducted.*

On a new boat and at least once a year, inspect the system when under a strong load. On a calm day and under power, go away from the other boats and with the person who is assigned the maintenance watching from below, put the wheel hard over at full throttle. The maintenance man should watch carefully for all parts of the system bending, distorting, creaking, or giving any indication of failing if placed under a heavy load for a period of time. If, for any reason something did fail or needs adjusting, the day is early and you will have plenty of time.

When leaving your boat at her mooring or slip, make sure that your wheel is properly tied off. **DO NOT LEAVE THE STEERING SYSTEM TO FREE WHEEL.**

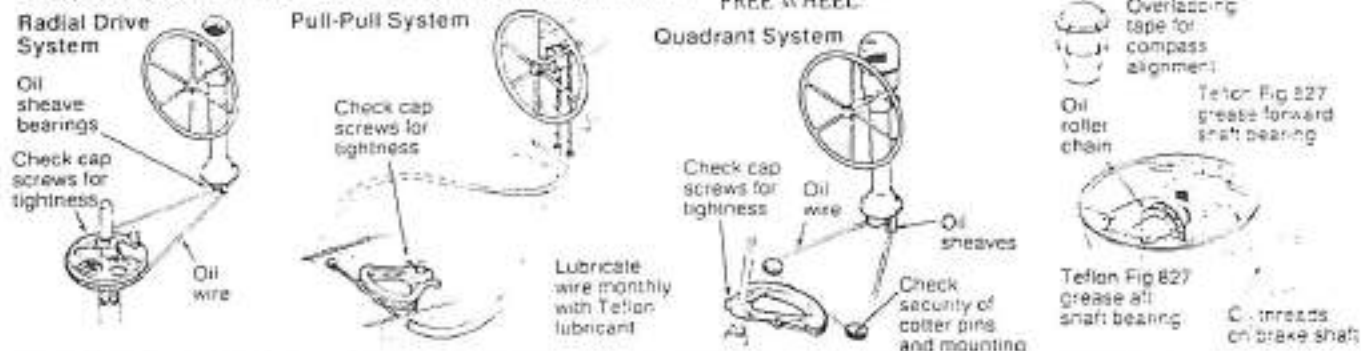

CLEANING STAINLESS STEEL

Pedestal guards, steering wheels and shafts are all made from top quality stainless steel. The implication of its name "stainless steel" does not mean it is totally rustproof. All stainless steel will rust to a certain degree due to chemical reaction to air and saltwater. This is mainly cosmetic and will require an occasional polishing with an abrasive type cleaner such as "Brasso" or equivalent.

CLEANING PEDESTAL AND ACCESSORIES

Clean them with soap and water; don't use chemicals such as MEK or acetone as they break down the super finish on your Edson pedestal

system, compasses and instruments. Most manufacturers of compasses and electronic instruments suggest that they all be removed during winter storage and kept in a warm dry area. Compasses are normally held in place by two or three slotted-head screws, placed near the top of the compass. A Fig 672 Rubber Connector will assist in removing the compass. Instruments can be removed by the screws in the Edson faceplate. Just unplug the instrument and you are all set.

CAUTION: When the equipment is in the tropics or in charter service, the maintenance schedule must be speeded up. Or, to put it in a few words: clean it up, oil it, inspect it, cover it. The effects of sun, saltwater and inexperienced operators can be severe.

LUBRICATION RECORD

component	lubricant	schedule	1st year	2nd year	3rd year	4th year	5th year	6th year	7th year
			19__	19__	19__	19__	19__	19__	19__
sheave bearings	#30 oil*	check and oil monthly							
pull-pull cables	Teflon Fig 827	check and grease monthly							
wire rope	#30 oil*	check and oil annually							
roller chain	#30 oil*	check and oil annually							
pedestal shaft bearings	Teflon Fig 827	check and grease annually							

*Any light oil is suitable. We recommend #30 weight motor oil since most boat owners have it aboard.

CAUTION: 1.) On extended voyages your steering system should be inspected each day and lubricated weekly. Carefully inspect your steering system at least 4-6 weeks before a vacation cruise to avoid last minute maintenance.
2.) When the boat is unattended secure the wheel with the brake or a line. In rough weather the rudder can swing violently from side to side causing damage.

As a further service to our customers we have an illustrated parts breakdown showing the design and construction of your Edson Pedestal Steerer. These parts drawings will assist you in the proper maintenance of your steering system.

If disassembly should become necessary, the following instructions will provide a simple but precise method of removing and replacing the steering shaft and its components.

DISASSEMBLY

1. With the wheel and brake assembly removed, replace the wheel nut with any standard thread $\frac{3}{4}$ " or 1" hex nut.
 2. Loosen the steering cables and chain by backing off the take-up eyes at the Quadrant or Radial Driver. Lift the chain off the sprocket and tie to the forward part of the bowl.
 3. Put a cloth just under the sprocket so no parts drop down.
 4. Align the notch in the alt nylon washer with the "V" stamped on the sprocket.
 5. Carefully drive the pin out of the sprocket (drive from the round end toward the grooved end).
 6. With a piece of wood against the $\frac{3}{4}$ " or 1" hex nut, gently tap the wheel shaft from the housing (see illustration); be careful not to drop the shaft components into the pedestal.
 7. Remove the sprocket, two nylon washers and forward needle bearing.
 8. Remove aft needle bearing and washers.
 9. Wipe out any dirt or old grease before reassembly.
- To reassemble, reverse the above procedure; do not grease the bearings until reassembly is completed.

NOTE: Check your compass for possible readjustment.

When ordering spare parts give the pedestal serial number, part number, part name, and quantity. Your order will be filled promptly.

If you have any questions don't hesitate to call the Edson factory. We will be pleased to assist you. All steerer parts are under Fig 960; see price pages.

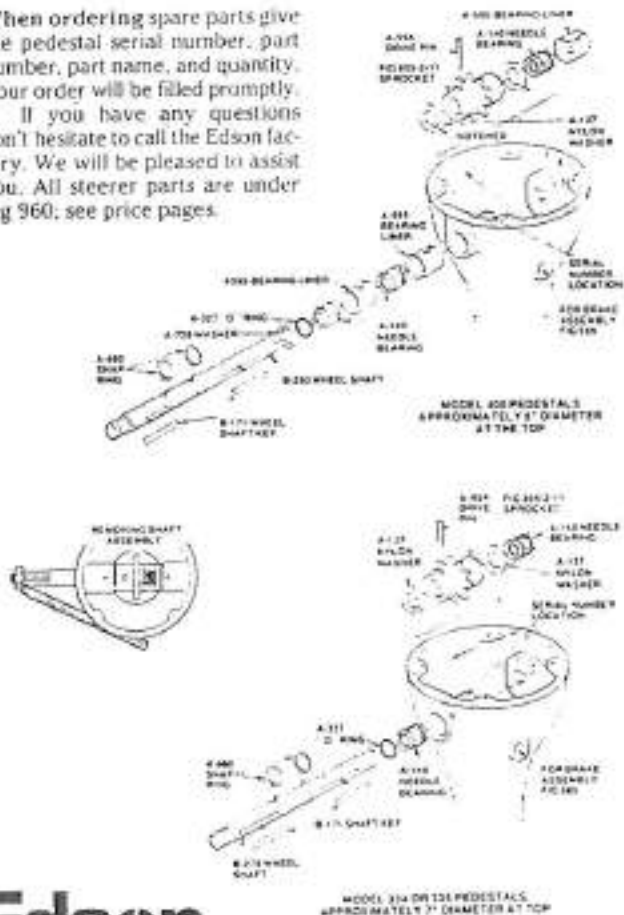

ENGINE CONTROLS INSTALLATION

Great care must be taken to assure ease and safety of engine controls operation. Components must be installed and adjusted so the engine goes into gear smoothly and completely, and the throttle operates easily. Cables must be installed straight or in broad curves. Refer to the Engine Connections illustrations (opposite) for installation procedures. Don't force engine controls when operating above idle. Force-shifting can result in broken cables and loss of boat control. Familiarize yourself with the operation of the engine controls. Caution and train all those on board.

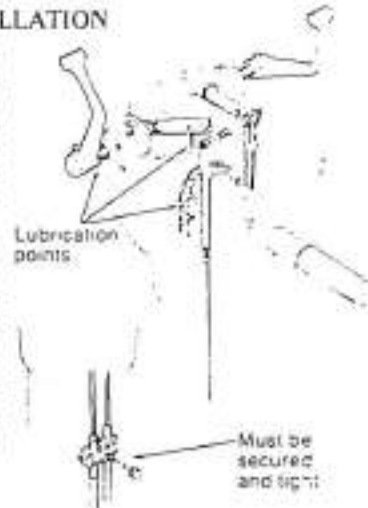

ENGINE CONNECTIONS

NOTE: Use the information below as a guideline. Most engine and control cable manufacturers furnish instructions for installing their products. Use their instructions if there is any variance with the instructions shown below.

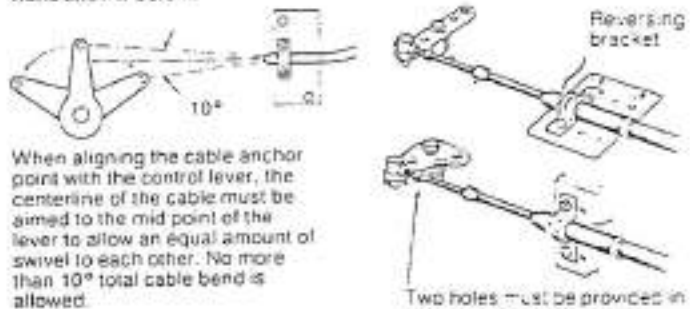

Two holes must be provided in the engine throttle lever to optionally select the proper travel. Holes, both 1 1/2\"/>

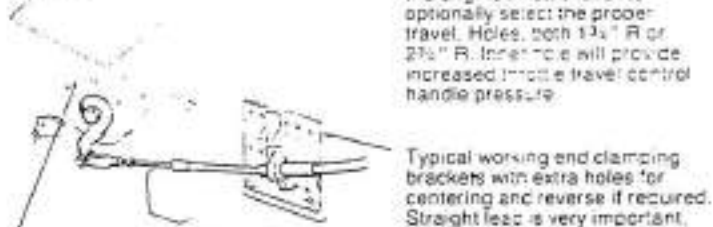

Another method of reversing the transmission

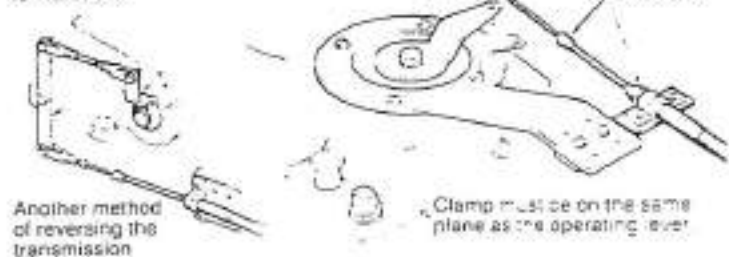

ENGINE CONTROLS MAINTENANCE

Oil the control handle shaft bearings with #30 motor oil. Use a good grade of Teflon spray with an extender nozzle for the pedestal end of the engine control push/pull cables.

At the engine, clean off the control cable metal ends and spray with Teflon grease. This will increase cable life and make operation easier. Engine cables are subject to high heat from the transmission, and salty bilge water, both very hard on moving parts. If still, replace.

VIPLEX ACRYLICS FOR MARINE USE

CARE AND CLEANING

Dont's

- * Do not subject acrylic material to high temperature when polishing.
- * Do not use glass cleaning sprays, scouring compounds, or solvents like acetone, gasoline, benzene, carbon tetrachloride or laquer thinner.
- * Do not use masking tapes, duct tapes or packing tapes on your acrylic materials.
- * Do not drill holes without proper drill bits in your acrylic materials (special bits are used in acrylic material to avoid damage).

Do's

- * Wash your acrylic hatches, windshields, and other acrylic components on your boat with a mild soap and plenty of lukewarm water.
- * Use a clean soft cloth, applying only light pressure.
- * Rinse with clear water and dry by blotting with a damp cloth or chamois.
- * Grease, oil or tar may be removed with a good grade of hexane, aliphatic naphtha, or kerosene. These solvents may be obtained at a paint or hardware store and should be used in accordance with the manufacturers recommendations.
- * To maintain a high-luster finish on your acrylics, we recommend that after properly cleaning, apply Megulars Mirror Glaze #10 with a soft towel. Note: If slight scratches appear on acrylics, use Megulars Mirror Glaze #17.

STORAGE/WINTERIZATION

IMPORTANT: Winter storage is recommended to be done in one of the following three ways: either 1) by blocking the boat via a cradle; or 2) with chained stands on level ground; or 3) by storing the boat in the water with a bubbler system to prevent icing. Damage to your boat, including engine misalignment caused by twisting, is not covered by the warranty.

SAILS

Sails should be properly folded and stowed in a dry, well ventilated place. Many sailboat owners send their sails back to the sail manufacturer at the end of each season. The sailmaker will check the stitching and sailcloth for wear and store the sails until the start of the next season.

ELECTRICAL

Remove battery from boat. (Refer to Engine Manual.) and charge. It is a good idea to also to remove the electronics (Radio, Radar, etc.) and store in a safe place.

CUSHIONS

Cushions should be removed and stored at home if possible. If not, prop them vertically to promote airflow around each cushion. *Dry Clean Only!*

HATCHES

Tenting the deck during storage will help prevent ice from forming and damaging hatches and deck fittings. The installation of a passive vent will help with ventilation while the boat is in storage.

WATER SYSTEM - WATER HEATER

WATER SYSTEM:

Open a faucet and allow the pump to empty the tank. Then add approximately two gallons of non-toxic anti-freeze solution to the tank and repeat the pumping out procedure.

A second method is to disconnect the hoses at the pump, allowing them to drain. Find the lowest point in the system and disconnect the fitting. Open all faucets to allow the lines to drain. If possible, use a short piece of hose on the faucet to blow through the lines to clear all water. A diluted solution with baking soda will help freshen the system.

WATER HEATER:

Open valve and drain fully. Leave valve open during lay-up time.

TOILET AND HOLDING TANK

Drain and flush toilet. Using automotive anti-freeze (ethyleneglycol) in a 50/50 mixture with water, pump through toilet and into holding tank. Refer to Galley/Head section for instructions.

STORAGE/WINTERIZATION CONTINUED.

ENGINE

1. Drain the cooling water completely out of the engine and flush the line thoroughly with fresh water. Don't use high pressure through the line.
2. Remove the fuel completely from all fuel lines.
3. Disconnect the main battery cables from the battery terminals.
4. To prevent corrosion inside the cylinders, pour a little lubricating oil into the suction pipe while turning the engine. Enough oil to reach the intake/exhaust valve is sufficient.
5. Put the piston at top dead center of compression stroke so that the intake/exhaust valves are completely closed.
6. Apply a thin anti-corrosion treatment to the plating and exposed painted surfaces.
7. The engine should be in a well ventilated area, and protected from any kind of dampness.
8. Put a dust cover over the engine.
9. Check your operation manual for engine diagram and for "Manufacturer's Recommended Winterizing Procedures."

OUTBOARD ENGINE

Take it home and store it in a safe place. Be very careful storing the gas tank as the gasoline is very flammable. Refer to "Engine Manual" for specific maintenance schedule.

DEPARTURE FROM THE BOAT

The check list for leaving a boat unattended is very important because items overlooked often will not be remembered until you are far from the boat and corrective actions are impractical or impossible. Primary choices for this list are items relating to the safety and security of the unattended craft—turning off fuel valves, the proper settings for electrical switches, pumping out the bilge and leaving the switch on automatic (or arranging for periodic pumping out). Other departure check list items are securing ports, windows, hatches, and doors.

ROUTINE MAINTENANCE

Routine maintenance check lists should include items based on how much the boat is used (usually in terms of engine hours) and on calendar dates (weekly, monthly, or seasonal checks). Typical of the former are oil level checks and changes, and oil and fuel filter changes.

On a calendar basis the lists should note such matters as electrolyte levels in storage-batteries, pressure gauges on dry-chemical fire extinguishers, and all navigation lights. Check the operation of automatic bilge alarms or pump switches by running water into the boat. Periodically close and open seacocks several times to ensure their free and easy operation in case they are needed in an emergency. Equipment and supplies carried on board for emergencies should be inspected for any signs of deterioration.

Raytheon

RAY 82 VHF/FM Radiotelephone

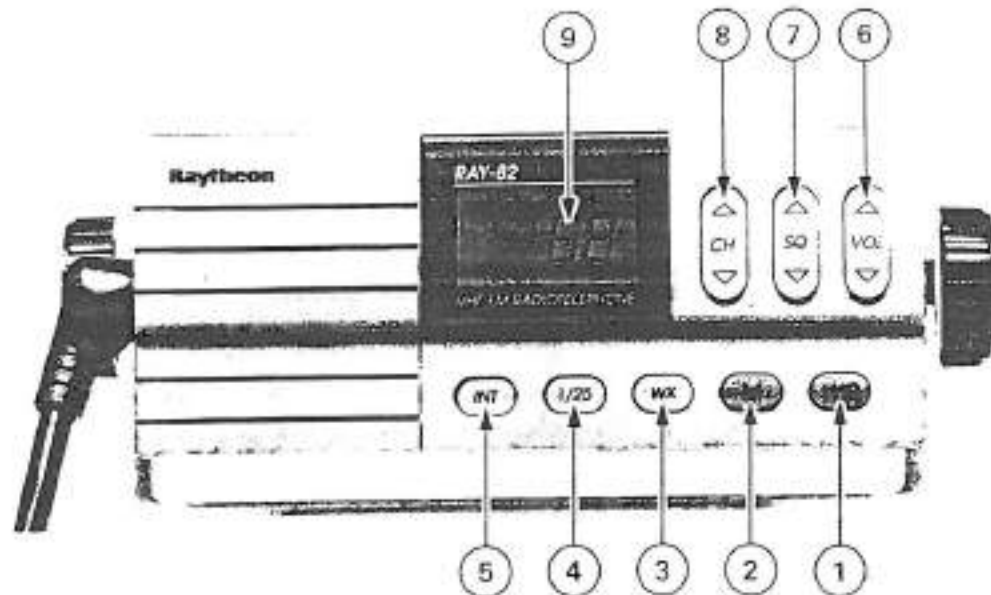

CONTROLS

- | | |
|---------------------------|--------------------|
| ① PWR (Power) Key | ⑦ SO (Squelch) key |
| ② CH 16 key | ⑧ CH (Channel) key |
| ③ WX (Weather) key | ⑨ LCD Mode Display |
| ④ 1/25 key | |
| ⑤ INT (International) key | |
| ⑥ VR (Volume) key | |

OPERATING PROCEDURES

Initial Setting of Controls:

PWR key — OFF
Squelch Control — Minimum

- | | |
|---------------------------|---|
| 1) POWER ON | — Press [PWR] key (Unit turns ON and automatically selects CH 16, USA). |
| 2) SET VOLUME | — Press Volume control key [▲] or [▼] for a comfortable level. |
| 3) SET SQUELCH | — Press Squelch control key [▲] or [▼] until noise ceases. |
| 4) SELECT DESIRED CHANNEL | — USA: Press CH up, down key |
| | — International: press [INT], then press CH up, down key |
| | — Weather, press [WX], then press CH up, down key. |
| 5) TO TRANSMIT | — a. Select desired power level 1W or 25W. Press 1/25 key.
(In U.S. harbors 1W is recommended) |
| | — b. Press PTT, speak into microphone. |
| | — c. Release PTT to receive. |

Table 3-1
RAY-83 MARINE VHF RADIOTELEPHONE CHANNELS

CHANNEL DESIG	DISPLAY	FREQUENCY		SIMPLEX DUPLEX	CHANNEL DESIG	DISPLAY	FREQUENCY		SIMPLEX DUPLEX
		SHIP RX	SHIP TX				SHIP RX	SHIP TX	
01	01+	160.650	156.050	D	62	62+	160.725	156.125	D
1A	01	156.050	156.050	S	62	62	160.725	156.125	D
02	02+	160.700	156.100	D	63	63+	160.775	156.175	D
2A	02	156.100	156.100	S	63A	63	156.175	156.175	S
03	03+	160.750	156.150	D	64	64+	160.825	156.225	D
3A	03	156.150	156.150	S	64	64	160.825	156.225	D
04	04+	160.800	156.200	D	65	65+	160.875	156.275	D
4A	04	156.200	156.200	S	65A	65	156.275	156.275	S
05	05+	160.850	156.250	D	66	66+	160.925	156.325	D
5A	05	156.250	156.250	S	66A	66	156.325	156.325	S
06	06+	156.300	156.300	S	67	67+	156.375	156.425	D
6	06	156.300	156.300	S	67	67*	156.375	156.375	S
07	07+	160.950	156.350	D	68	68+	156.425	156.475	D
7A	07	156.350	156.350	S	68	68	156.425	156.425	S
08	08+	156.400	156.400	S	69	69+	156.475	156.525	D
08	08	156.400	156.400	S	69	69	156.475	156.475	S
09	09+	156.450	156.450	S	70	70+	156.525	156.575	S
09	09	156.450	156.450	S	70	70	156.525	156.525	S
10	10+	156.500	156.500	S	71	71+	156.575	156.625	D
10	10	156.500	156.500	S	71	71	156.575	156.575	S
11	11+	156.550	156.550	S	72	72+	156.625	156.675	D
11	11	156.550	156.550	S	72	72	156.625	156.625	S
12	12+	156.600	156.600	S	73	73+	156.675	156.675	S
12	12	156.600	156.600	S	73	73	156.675	156.675	S
13	13+	156.650	156.650	S	74	74+	156.725	156.725	S
13	13*	156.650	156.650	S	74	74	156.725	156.725	S
14	14+	156.700	156.700	S	75	75+	156.775	-----	---
14	14	156.700	156.700	S	75	75	156.775	-----	---
15	15+	156.750	156.750	S	76	76+	156.825	-----	---
15	15	156.750	-----	S	76	76	156.825	-----	---
16	16+	156.800	156.800	S	77	77+	156.875	156.875	S
16	16	156.800	156.800	S	77	77	156.875	156.875	S
17	17+	156.850	156.850	S	78	78+	161.525	156.925	D
17	17	156.850	156.850	S	78A	78	156.925	156.925	S
18	18+	161.500	156.900	D	79	79+	161.575	156.975	D
18A	18	156.900	156.900	S	79A	79	156.975	156.975	S
19	19+	161.550	156.950	D	80	80+	161.625	157.025	D
19A	19	156.950	156.950	S	80A	80	157.025	157.025	S
20	20+	161.600	157.000	D	81	81+	161.675	157.075	D
20	20	161.600	157.000	D	81A	81	157.075	157.075	S
21	21+	161.650	157.050	D	82	82+	161.725	157.125	D
21A	21	157.050	157.050	S	82A	82	157.125	157.125	S
22	22+	161.700	157.100	D	83	83+	161.775	157.175	D
22A	22	157.100	157.100	S	83A	83	157.175	157.175	S
23	23+	161.750	157.150	D	84	84+	161.825	157.225	D
23A	23	157.150	157.150	S	84	84	161.825	157.225	D
24	24+	161.800	157.200	D	85	85+	161.875	157.225	D
24	24	161.800	157.200	D	85	85	161.875	157.275	D
25	25+	161.850	157.250	D	86	86+	161.925	157.325	D
25	25	161.850	157.250	D	86	86	161.925	157.325	D
26	26+	161.900	157.300	D	87	87+	161.975	157.375	D
26	26	161.900	157.300	D	87	87	161.975	157.375	D
27	27+	161.950	157.350	D	88	88+	162.025	157.425	D
27	27	161.950	157.350	D	88A	88	157.425	157.425	S
28	28+	162.000	157.400	D	89	89+	156.025	156.025	S
28	28	162.000	157.400	D	* 60A	89	156.025	156.025	S
60	60+	160.625	156.025	D	90	90+	156.075	156.075	S
60	60	160.625	156.025	D	* 61A	90	156.075	156.075	S
61	61+	160.675	156.075	D	91	91+	156.125	156.125	S
61	61	160.675	156.025	D	* 62A	91	156.125	156.125	S
					92	92+	156.225	156.225	S
					* 64A	92	156.225	156.225	S

* These channels are available only in the International (INT) mode.

⊗ These channels are assigned by the Canadian Government. Ensure proper authorization prior to use.

S: SIMPLEX, D: DUPLEX, ---: NO TX

* These Channels are programmed to Transmit at 1 watt. 25W may be selected, whenever necessary, by pressing the 1/25 key.

CHANNEL DESIG.	DISPLAY	FREQUENCY			
		SHIP RX	SHIP TX		
W1	1	162.550	-----	Rev	NOAA Weather
W2	2	162.400	-----	Rev	NOAA Weather
W3	3	162.475	-----	Rev	NOAA Weather
W4	4	161.650	-----	Rev	Canada Weather
W5	5	162.425	-----	Rev	NOAA Weather
W6	6	162.450	-----	Rev	NOAA Weather
W7	7	162.500	-----	Rev	NOAA Weather
W8	8	162.525	-----	Rev	NOAA Weather
W9	9	161.775	-----	Rev	Canada Weather

Raytheon

Document No. G263392-3 Rev-1/90
Printed in Japan

ORIGO 6000

U.S. Pat. No. 4,416,617 other patents pending

INSTRUCTIONS

ORIGO 6000 is a non-pressurized alcohol stove with the fuel absorbed in a non-flammable pulp. ORIGO 6000 has no valves to develop leaks or other components in need of regular service. This makes ORIGO 6000 safe and easy to maintain.

As always — when working with a naked flame — certain precautions are required. Accordingly read the following simple instructions carefully before using your new ORIGO 6000 stove.

If an accident should ever occur, remember that burning alcohol can be extinguished with water.

LOCATION OF YOUR NEW ORIGO 6000

Your stove should be located in a well-ventilated space. Avoid excessive draft. Mount the stove as far away from combustible materials as possible. Preferably mount the stove in a metal lined space.

DESCRIPTION (Photo 1)

- 1 Stove top burner opening
- 2 Stove top regulator knob
- 3 Catch button
- 4 Locking screw, oven burner lid
- 5 Oven burner regulator knob
- 6 Oven thermometer

TO FILL TOP BURNERS, OPEN THE STOVE TOP

For safety reasons the stove top can only be opened when the flames are extinguished, so turn the knobs to 0 position. Press the catch button and lift the top (Photo 2).

Lift out tank unit. Tank must not be filled near an open flame or a hot object.

It is essential that the flame from previous use has been completely extinguished, and that there is no heat glow on burner top. During use, the tanks are heated and the fuel requires space to expand. It is therefore important to avoid overfilling the tanks. The tank openings are recessed to facilitate filling.

Hold the tank as shown in photo 3, with the recess pointing down and pour the fuel directly into the opening covered by the wire mesh.

Check quantity by raising to vertical. When fuel is visible in recess, stop filling (Photo 4).

After filling, make certain no excess fuel remains in stove. Always wipe tanks dry. Place tanks in stove. Check that they fit properly in mountings. Close the stove. Knobs in 0 position! Fold down the stove top, the catch will lock. (Make certain that the regulating plates cover the burner openings so that the stove top is level).

TO LIGHT (Photo 5)

Turn regulator knob counter-clockwise to open burner. Place a lighted match or lighter (optional extra) at burner opening. (Match can be dropped in and removed at next filling).

If the stove is warm (from previous use), burner may ignite suddenly and simultaneously extinguish. If this happens, blow down into burner opening to dissipate alcohol vapor, and re-light. Winterize your stove by burning remaining fuel.

TO EXTINGUISH

Turn regulator knob fully clockwise.

TO REMOVE GRID (Photo 6)

At the back of the stove top is an oblong hole, into which the grid retaining hook fits. To remove grid, slide hook out of retaining hole, and grid can be lifted off.

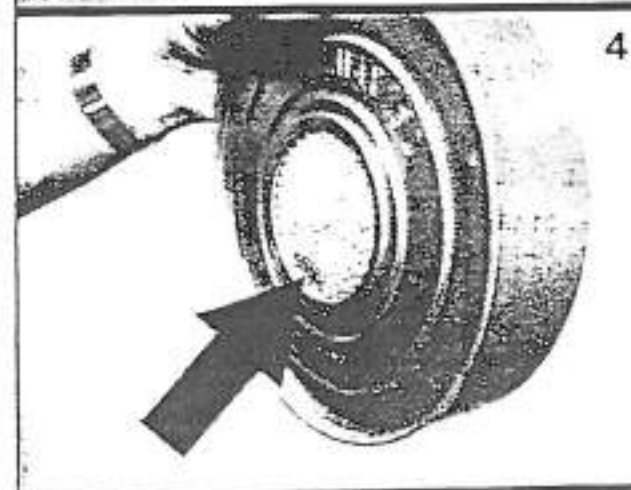
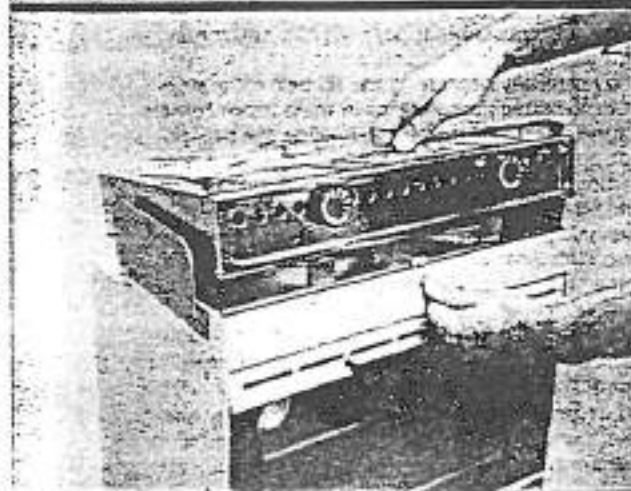
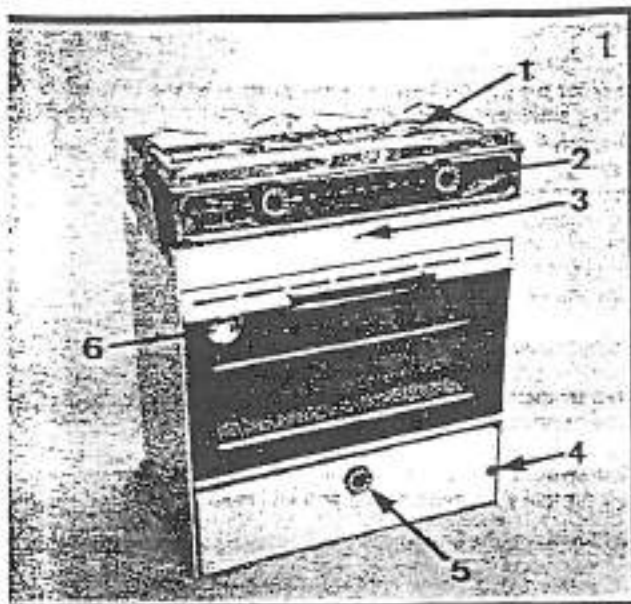

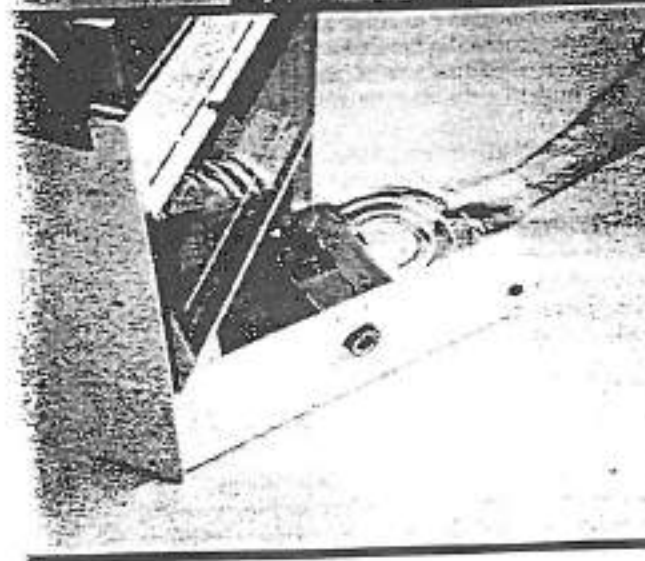
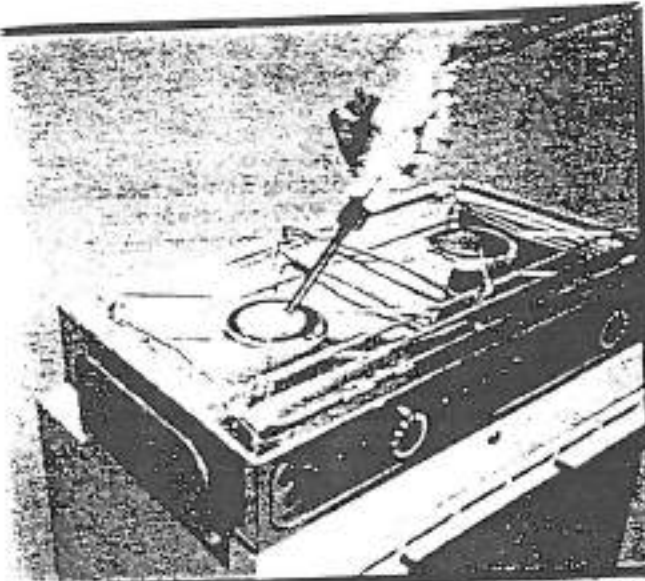

OVEN

The tank and burner for the oven is located in the bottom of the stove. Access to filling and lighting is through the lower lid. Unscrew the locking screw and open lid. Pull out the tank, while pressing the click spring (Photo 7) and fill according to instructions above. When reinserting the tank into its compartment, check that it is in the right position and that the click spring has engaged. The burner can now be lighted as described above and lid closed. Access to light the oven can also be gained by lifting the bottomlid inside the oven.

Extinguish by turning regulator knob fully clockwise.

Heat oven to desired temperature with burner fully open and reduce flame when the temperature is reached.

The first time you use your oven you will experience quite a strong smell. This is normal with most ovens and will cease after a while.

INSTALLING

ORIGO 6000 is delivered with gimbals. It is recommended that these are used, but it is also possible to screw it to a horizontal surface, should this be preferred. It is possible to open the oven burner lid widely by carefully depressing the lid below the stopper to gain access to the attachment means in the bottom corners. When fitting the stove with gimbals, first determine the best position for the pivot points. This can be done by placing the stove in the desired position, open the stove top and mark through the holes in the gimbal sideplates. Remove the stove, fasten the pivot arms with fiber washers and screws removed. Fit one fiberwasher with round hole on each pivot and lift the stove from below up between the pivots so that the gimbal sideplates will spring into place on the pivots. With open stove top fit the fiber washers with oblong holes, make certain that they fit properly on the pivots so they can't rotate. Fit steelwashers, screws and tighten. Adjust the tension of the screws to desired friction.

Whether the fixed or gimballed installation is used or not, it is very important that there is ample distance to the surrounding fittings. To secure the distance along the sides, the gimbal side plates shall not be removed.

At the back of the stove is an outlet for hot air. A clearance of 4 inches to the fittings behind is required. If gimballed, allow for ample room to swing.

GASKETS

The stove is supplied with rubber gaskets. They may be used if your stove is stored for some time. They also prevent evaporation in hot climate.

Use this way: fold up the stovetop, check that the stove has become cold. Put the gaskets over the tank openings. Fold down the stovetop to horizontal position and open the burners to lock the top in closed position.

OPTIONAL EXTRAS

Potholders
Lighter

WARNING

TO BE USED ONLY WITH DENATURATED ALCOHOL.
MUST NEVER BE USED WITH GASOLINE, KEROSENE,
DIESEL OR ANY OTHER TYPE OF FUELS.

TECHNICAL DATA

Height:	approx. 21 1/8" (537 mm)	excl. cooking grid
Depth:	approx. 13 3/16" (335 mm)	
Length:	approx. 18 1/4" (464 mm)	
	approx. 20 1/16" (510 mm)	incl. gimbal
Fuel tanks:	approx. 2,5 pints each tank (1,2 L)	
Fuel:	denatured alcohol	
Efficiency:	Will boil 2 pints of water in approx. 7 minutes	

ORIGO USA INC.
1121 LEWIS AVE.
SARASOTA
FLORIDA 33577
USA

GALLEY/HEAD SYSTEMS

WATER SYSTEM OPERATION

Fill fresh water tank at deck fill. The tank filler cap will be marked "water". When tank is full, water will back up through the vent hose and exit through a vent located on the side of the hull

To activate the water system, flip the "water pressure" switch on the electrical panel. This will start the pump and pressurize the system. When the pressure builds, the pump will shut off . With continued use of fresh water the pressure in the system is reduced, automatically re-starting the pump. Make sure there is water in the system while pump is in operation to prevent damage to the motor.

If pump kicks in frequently without system use, you may have a leak in the system and it should be checked. **Do not activate water heater unless there is water in the system.**

To operate shower, turn on hot & cold faucets until desired temperature is reached, while shower head is retracted at sink. Pull the shower head out and use. The faucets must be turned off to prevent system drainage.

Opening the faucet will allow the pump to empty the tank. Flushing the tank and lines will be necessary for winterization. Refer to Maintenance & Winterization section for more information.

SPECIALTY FAUCET

with Pull-Out Spray



Spray Head In

□ 31.546 Chrome



Spray Head Out

□ 31.546 Chrome

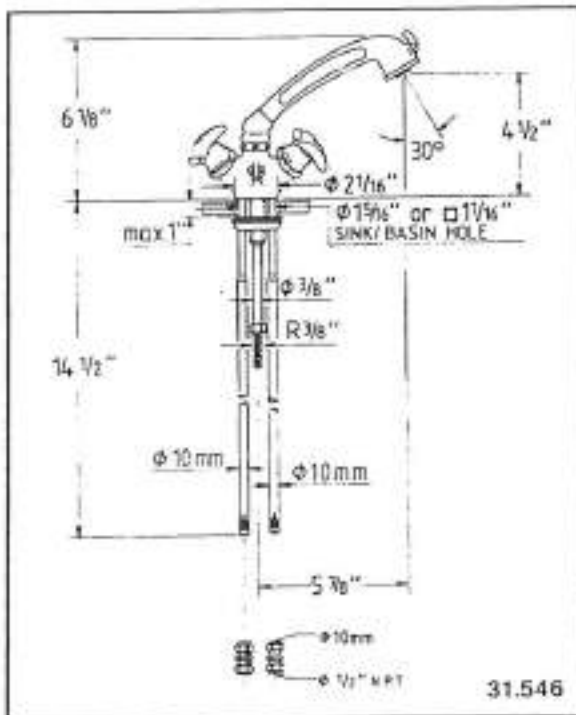

SPECIFICATIONS

- Two handle special use faucet with pull out spray
- All brass body with longlife compression cartridges
- Single hole mounting through $1 5/16"$ round or $1 1/4"$ square basin hole
- Vandal resistant color coded handles
- Spray or stream flow head
- 59" metal hose
- 14 1/2" metric supply tube
- Metric to U.S. 1/2" NPT adapters supplied
- Maximum test pressure 230 psi
- Maximum operating pressure 150 psi
- Recommended operating pressure 15-75 psi
- Maximum water temperature 180°F

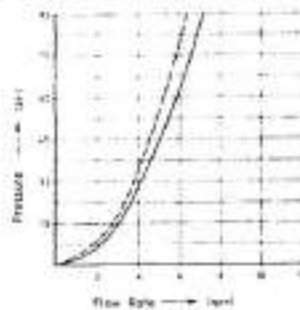

Standard—
Spray--

GROHE AMERICA



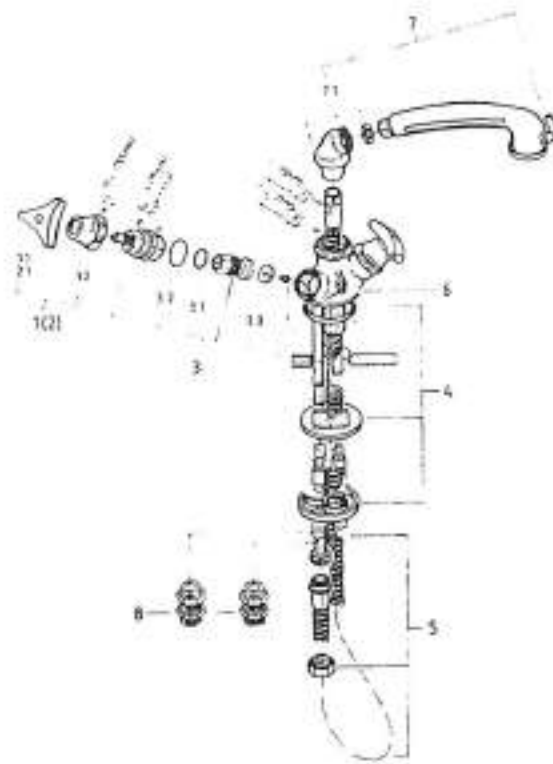

31.546

DRG REF	PART DESCRIPTION	PART NUMBER	PACK SIZE	MODEL NUMBER
1	Tricorn Handle, Blue with Flange	45.080	1	X
1.1	Tricorn Handle, Blue	06.113	1	X
1.2	Flange	01.702	1	X
2	Tricorn Handle, Red with Flange	45.081	1	X
2.1	Tricorn Handle, Red	06.114	1	X
3	Cartridge	07.146	1	X
3.1	Cartridge Spindle "O"-Ring	01.283	20	X
3.2	Body Seal "O"-Ring	03.924	10	X
3.3	1/2" Seat Washer	05.291	50	X
4	Mounting Set	45.046	1	X
5	Metal Hose	28.112	1	X
6	Chain Support	01.161	1	X
7	Hand Spray	28.011	1	X
7.1	Elbow	06.349	1	X
8	Connector 10mm x 1/2"NPT	12.080	1	X

GROHE AMERICA

GROHE AMERICA, INC. 
 900 Lively Blvd., Wood Dale, IL 60191
 312/350-2600

<https://www.boat-manuals.com/>

PAR

Models 29090-0000 29120-0000



OPERATION

Manual Marine toilets have traditionally been somewhat cumbersome and confusing to operate and maintain. The PAR toilet has been designed with user convenience in mind. The pump assembly is angled forward to provide a natural, smooth stroke action. It has a top mounted wet/dry bowl selector which can be operated with the same hand used for pumping without releasing the pump handle.

The PAR toilet is surprisingly easy to operate. Simply move the wet/dry bowl selector to the wet bowl position (left) and pump handle up and down a few times to add some water to the bowl prior to use. After using, flush by again pumping handle up and down (in wet bowl position) until bowl is thoroughly rinsed and evacuated. Then move the wet/dry bowl selector to the dry bowl position (right) and continue pumping until only about one cup of water remains in the bottom of bowl. Leave the wet/dry bowl selector in the dry bowl position when toilet is not use.

APPLICATION

The PAR Manual toilet is designed to meet the requirements of onboard marine applications. It may be installed above or below the waterline (special plumbing requirements apply to below waterline installations). The toilet may be plumbed so waste is discharged to holding tank, directly overboard (where permitted by law) or into a certified waste treatment device. For installation versatility, the pump assembly may be positioned on the left or right hand side of the bowl. Its multi-angle discharge port will allow routing of discharge hose in almost any direction for ease of installation and neat appearance.

The toilet is available with either a compact china bowl to fit restrictive areas or a large bowl with household size seat assembly for maximum comfort. Its forward angled double action pump with convenient top mounted dry bowl selector is easy and natural to operate. It is self-priming with a dry suction lift of up to 3 feet (1 meter) and a discharge head to 9 feet (3 meters). A full-flow triadic joker valve resists blockage while providing positive back-flow prevention.

WARNING: Hazard of flooding. If toilet is installed below the waterline, it must be installed with properly positioned vented loops. Failure to do so may result in flooding which can cause loss of property and life.

MANUAL MARINE TOILET

FEATURES

- Easy to clean white ceramic bowl
- Sturdy wood seat with durable baked enamel finish
- Forward angled pump for easy operation
- Convenient top-mounted dry bowl selector
- Reversible pump mounting for right or left hand installation
- External seal housing/rod guide for easy replacement
- Smooth external surfaces with skirted base to maintain cleanliness
- Triadic full-flow joker valve to avoid accidental blockage
- Multi-angle discharge port for versatility of plumbing connection

Specifications: Inlet port – $\frac{3}{4}$ ", Discharge port – $1\frac{1}{2}$ "
Weight – compact bowl: 26 lb.
 large bowl: 32 lb.

MODELS AVAILABLE

29090-0000	Compact Size Bowl & Seat
29120-0000	Household Size Bowl & Seat

Models 29090-0000 29120-0000

Positioning and Mounting

The PAR Manual Toilet is assembled at the factory for operation with the right hand. If preferred, or required by available space, the pump and bowl may be rotated 180 degrees to provide left hand operation. To do this, remove hose from inlet elbow (back of bowl) and rotate elbow 180 degrees. It may be necessary to remove the elbow, loosen spud retaining nut and rotate the spud fitting so elbow will be tight when pointing in the opposite direction. Remove, rotate 180 degrees and reinstall both the bowl and pump assembly. Reconnect hose to inlet elbow and the toilet is ready for left hand operation.

The toilet must be installed on a well supported flat surface. Ideally, if underside of mounting surface is accessible, the toilet base should be through-bolted (using 5/16" bolts, washers and locknuts) to the mounting surface. If the underside of mounting surface is not accessible, the use of 5/16" lag bolts and washers is an acceptable alternative.

Before installing, position toilet in location to be installed. Ensure there is adequate space around toilet to easily operate pump and raise seat and lid to a fully opened position. Seat and lid should swing open at least 110 degrees and be supported when open to avoid strain on hinges. Ensure the base drain plug is accessible and inlet and discharge hoses can be routed to their respective ports. The discharge elbow may be rotated (by loosening two flange screws, rotating elbow and retightening screws) to accept the most convenient routing of the discharge hose.

When proper installation has been established mark the four base mounting holes on mounting surface and remove toilet. Ensure that no wiring or plumbing is positioned under the mounting surface which may be accidentally damaged when the surface is drilled. Drill appropriate size holes for fasteners being used. Mount toilet using flat washers between head of bolts and plastic toilet base. If desired a small bead of silicone or latex sealant may be applied around base where it contacts the mounting surface to prevent moisture from getting under the toilet base.

NOTICE: Do not use Polysulfide base sealants because they may chemically attack the plastic which may result in breakage.

DIMENSIONAL DRAWING
INCHES (mm)

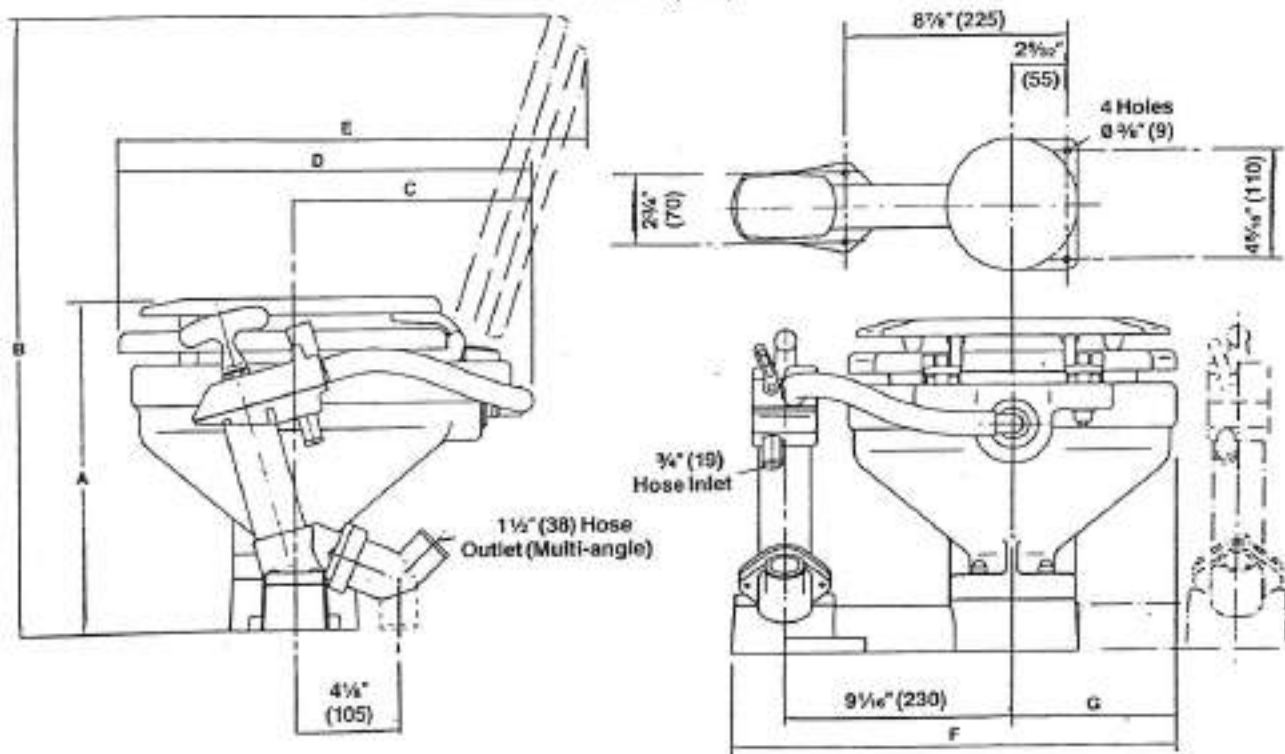

	A	B	C	D	E	F	G
29090-0000	13 3/16 (335)	24 1/4 (615)	9 3/4 (247)	16 3/4 (425)	19 1/8 (485)	17 3/4 (450)	6 1/2 (165)
29120-0000	13 3/16 (345)	27 3/4 (700)	11 (280)	19 9/16 (490)	22 7/8 (580)	18 5/16 (465)	7 1/8 (180)

One Year Limited Warranty

A. LIMITED WARRANTY: ITT warrants that at the time of shipment, the products manufactured by ITT and sold hereunder shall be in conformity with applicable written specifications and descriptions referred to or set forth herein, free from defects in material and workmanship, merchantable, and suitable for a particular purpose, provided such is implied by State law under the circumstances of this sale.

B. WARRANTY ADJUSTMENT:

- ITT agrees to repair or furnish a replacement for, but not to remove or install, any product or component thereof which, within one (1) year from date of purchase, shall upon test and examination by ITT prove defective within the above warranty. Receipt verifying purchase date is required to obtain adjustment.
- Buyer shall notify ITT of any defect within this warranty no later than ninety (90) days after the defect is discovered.
- No product will be accepted for return or replacement without the prior written authorization of ITT. Upon such authorization, and in accordance with instructions from ITT, the product will be returned to ITT, shipping charges prepaid by Buyer. Products returned to ITT will be addressed as follows:

ITT JABSCO
1485 Dale Way
Costa Mesa, California 92626-3998

Or to such alternate locations as may be designated on the product, its container, or this sheet.

Repair or replacement made under this warranty will be shipped prepaid to Buyer.

C. EXCLUSIONS FROM WARRANTY AND LIMITATION OF LIABILITY:

- The foregoing warranty is limited solely as set forth herein and applies only for the period designated above.

2. ITT SHALL NOT BE LIABLE FOR ANY LOSS, DAMAGE, SPECIAL OR CONSEQUENTIAL DAMAGE OF ANY KIND, WHETHER BASED UPON WARRANTY, CONTRACT, NEGLIGENCE, OR STRICT LIABILITY ARISING IN CONNECTION WITH THE SALE, USE, OR REPAIR OF THE PRODUCT.

3. THE MAXIMUM LIABILITY OF ITT IN CONNECTION WITH THIS WARRANTY SHALL NOT IN ANY CASE EXCEED THE CONTRACT PRICE FOR THE PRODUCT CLAIMED TO BE DEFECTIVE OR UNSUITABLE.

4. This warranty does not extend to any product manufactured by ITT which has been subjected to misuse, neglect, accident, improper installation, or use in violation of instructions furnished by ITT.

5. This warranty does not extend to or apply to any unit which has been repaired or altered at any place other than ITT's factory, or by persons not expressly approved by ITT, nor to any unit the serial number, model number, or identification of which has been removed, defaced or changed.

6. Components manufactured by any supplier other than ITT shall bear only that warranty made by the manufacturer of that product.

7. This warranty applies to products defined as "consumer products" by the Consumer Product Warranties Act as from time to time amended.

D. CONSUMER RIGHTS: This warranty gives you specific legal rights, and you may have other rights which vary from state to state. Some states do not allow exclusion or limitation of damages.

STANDARD WARRANTY: If the products manufactured and sold hereunder are not Consumer Products, the warranty extended to Buyer shall be as set forth in subparagraphs (a), (b), and (c), EXCEPT THAT ALL EXPRESS OR IMPLIED WARRANTIES OR MERCHANTABILITY OR SUITABILITY FOR ANY PARTICULAR PURPOSE ARE EXCLUDED.

ITT JABSCO
A Unit of ITT Corporation

1485 Dale Way, P.O. Box 2158, Costa Mesa, California 92626-2158, Telephone: (714) 545-8251
Bingley Road, Hoddesdon, Hertfordshire EN11 0BU England, Telephone: +44-992-467191

EXPLODED VIEW

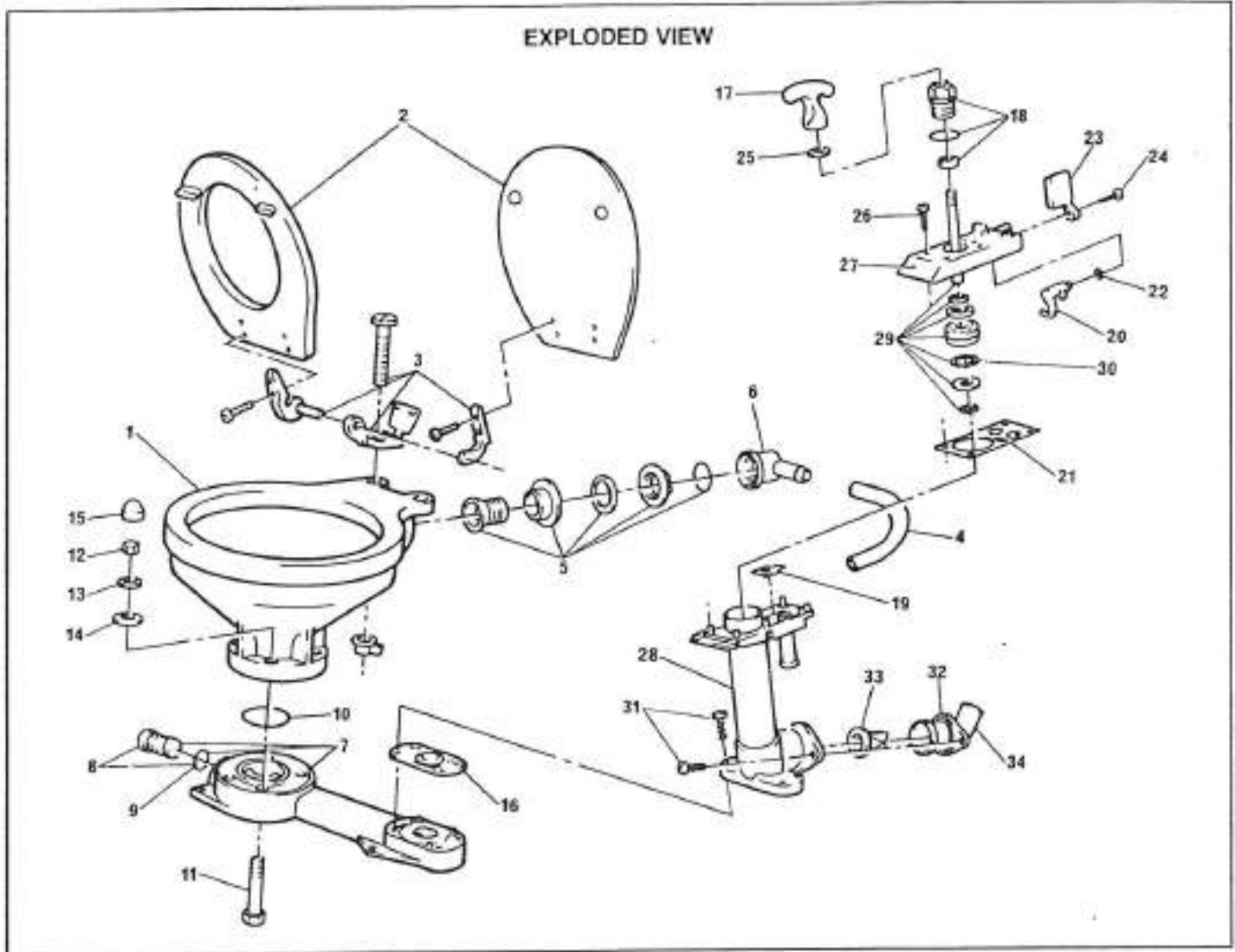

REPAIR KITS AVAILABLE

KIT	PART NO.	DESCRIPTION
A	29045-0000	MAJOR SERVICE KIT, PUMP
B	29040-1000	PUMP ASSEMBLY
C	29094-0000	VALVE COVER ASSEMBLY
D	29051-0000	PUMP CYLINDER ASSEMBLY
E	29047-0000	BOWL INSTALLATION KIT

PARTS LIST

KEY	DESCRIPTION	QTY. PER TOILET	PART NO.	QTY. PER REMARK					
				A	B	C	D	E	
1	BOWL	COMPACT	59127-7002						4
		LARGE	18753-0060						4
2	SEAT, LID & HINGE SET	COMPACT	43990-0065						4
		LARGE	18753-0061						4
3	HINGE SET (1 PAIR)	1	18753-0181					4	
4	HOSE	COMPACT	29035-0000						4
		LARGE	29035-0001						4
5	BOWL SPUD	1	29048-0000						
6	INTAKE ELBOW & O-RING	1							
7	BASE, PLUG & O-RING ASSY	1	29041-1000						
8	PLUG & O-RING ASSY	1	29028-1000						
9	O-RING (PLUG)	1		1					
10	O-RING (BOWL)	1		1				1	

PARTS LIST

KEY	DESCRIPTION	QTY. PER TOILET	PART NO.	QTY. PER REMARK				
				A	B	C	D	E
11	BOLT	4						4
12	NUT	4						4
13	WASHER (S.S.)	4						4
14	WASHER (NYLON)	4						4
15	CAP	4						4
16	BASE VALVE GASKET	1	29043-0000	1	1			
17	HANDLE	1	29026-0000					
18	SEAL ASSEMBLY	1	29044-0000	1	1	1		
19	TOP VALVE SEAT	1		1	1		1	
20	CAM	1				1	1	
21	TOP VALVE GASKET	1	29042-0000	1	1			
22	O-RING (FLUSH LEVER)	1		1	1	1		
23	FLUSH CONTROL LEVER	1				1	1	
24	SCREW (FLUSH LEVER)	1		1	1	1		
25	BUMPER	1		1	1			
26	SCREW (VALVE COVER)	6		1	6	6		
27	VALVE COVER	1				1	1	
28	PUMP CYLINDER	1				1	1	1
29	PISTON, ROD & O-RING ASSY	1	29046-0000	1				
30	O-RING (PISTON)	1		1				
31	SCREW (PUMP CYLINDER)	5			1	2	2	
32	DISCHARGE FLANGE	1	29091-0000			1	1	
33	JOKER VALVE	1	29029-0000			1	1	
34	DISCHARGE ELBOW	1	29029-0000			1	1	

Plumbing

If installing a new inlet thru-hull/seacock, ensure that it is positioned on a part of the hull which is wetted at all angles of heel or trim and free of water turbulence at any hull speed. If discharging waste overboard (check legal restrictions for overboard discharge), ensure discharge thru-hull/seacock is both aft of and higher than the inlet thru-hull/seacock. All inlet plumbing should be a minimum of 3/4" ID and discharge plumbing a minimum of 1 1/2" ID. All hose ends should be double clamped with stainless steel hose clamps.

If toilet is above waterline route hoses to seacocks, holding tank or treatment device via a route as direct as possible. However, for maximum sealing effect on the discharge joker valve, it is recommended that the discharge hose is looped upward about 8" above the discharge elbow before it descends to its termination point. All bends and elbows in plumbing should be kept to a minimum. It should not be necessary to use any sealing compound when attaching hoses to the inlet or discharge ports.

WARNING: Hazard of flooding. If toilet is installed below the waterline, it must be installed with properly positioned vented loops. Failure to do so may result in flooding which can cause loss of property and life.

If toilet is below waterline, a 3/4" vented loop must be installed in a length of hose connecting the flushing pump to the rear of the bowl. The vented loop fitting must be positioned 8" above the waterline at all angles of heel or trim. To accomplish this remove the 3/4" hose supplied with toilet and replace with a new length of hose long enough to properly position the vented loop. If the toilet is plumbed for overboard discharge, a 1 1/2" vented loop must be installed in the discharge hose. The waste vented loop fitting must also be positioned 8" above the waterline at all angles of heel or trim and ideally should be located as close to the toilet as practical.

Toilet below the waterline

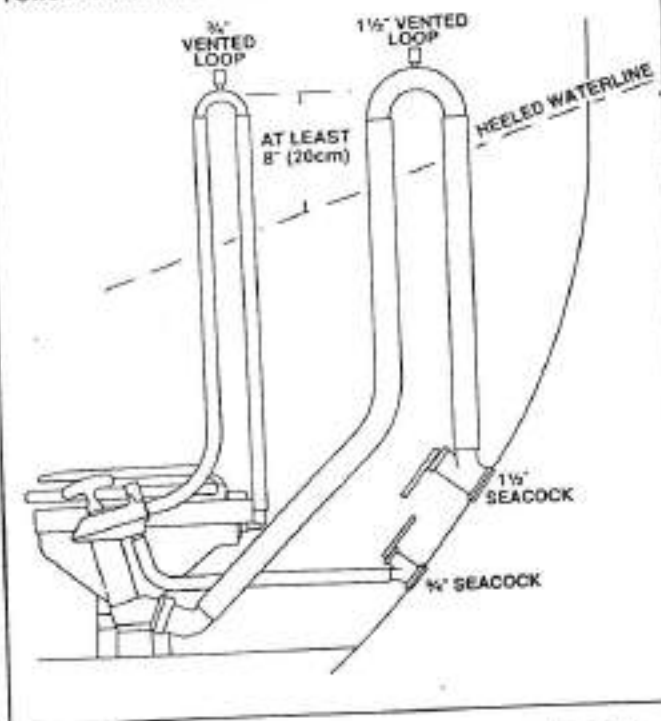

If unfamiliar with proper plumbing requirements for marine toilets, it is recommended that a qualified marine plumbing technician is contacted to do the installation.

MAINTENANCE/SERVICE INSTRUCTIONS

Maintenance

Periodic maintenance is generally not required; however, after long periods of non-use, the toilet may be easier to operate if lubricated. To do this, fill bowl half-way with warm water and add a few drops of mineral oil or baby oil. With the wet/dry bowl selector in the dry bowl position, empty bowl using long complete strokes. To winterize toilet, operate the pump in the dry bowl mode to evacuate as much water as possible. Drain the remaining water from the base by removing the base plug.

If charging the holding tank with anti-freeze by pumping it through the toilet, use only ethylene glycol based anti-freeze. To use petroleum based anti-freeze may cause damage to the internal rubber toilet parts.

Service

Before performing any service flush the toilet long enough to ensure all waste is flushed from the discharge hose. Close both inlet and discharge (if applicable) seacocks and put a "DO NOT OPEN" notice on each to guard against accidental opening and flooding while service is being performed.

SEAL REPLACEMENT – Lift handle and wrap rod with one turn of tape just under the handle. Gently grasp piston rod (on tape) with pliers and unscrew handle. **HOLD PISTON ROD AT ALL TIMES OR IT MAY DROP DOWN INTO PUMP.** Remove bumper washer and unscrew and remove seal/rod guide assembly. Wrap threads of piston rod with one turn of tape to protect new seal and install new seal/rod guide assembly. Remove tape from threads and reinstall bumper washer and handle. Tighten handle snugly (do not overtighten) and remove remaining tape.

MAJOR OVERHAUL – Loosen hose clamps on inlet hose and remove it from the pump. Remove bowl link hose from rear of pump assembly. Remove the two screws that secure the discharge

flange and elbow. Remove the four screws that secure the pump to the base and remove pump assembly. The discharge joker valve and base valve/gasket can now be removed. Remove the six screws that secure the top valve cover, move the wet/dry bowl selector to the wet bowl position and remove valve cover and piston rod assembly from pump cylinder. Remove top valve/gasket assembly and valve seat. Remove piston O-Ring and seal/rod guide assembly (see Seal Replacement instructions). Clean all parts and inspect for damage. Ensure pump cylinder wall is not badly grooved or worn.

Install new seal/rod guide assembly (see Seal Replacement instructions). Install new piston O-Ring. Lubricate bore of pump cylinder with petroleum jelly. Position valve seat and top valve/gasket assembly on top of cylinder. With the wet/dry bowl selector in the wet bowl position, insert piston into cylinder bore and position valve cover on top of cylinder. Secure with six screws. Install joker valve in discharge elbow and base valve/gasket assembly on base. Position discharge flange and elbow on pump and secure with two screws. Position pump assembly on base and secure with four screws. Reattach bowl link hose to pump. Reattach inlet hose to pump and secure with clamps.

BOWL SEAL REPLACEMENT – To replace the bowl seal (base O-Ring) disconnect inlet and discharge hoses and remove toilet from its mounting surface. Pry nut caps from bowl fasteners. Invert toilet and hold bolts on underside of base while removing nuts and washers. Lift base from bowl and remove O-Ring. Install new O-Ring, position base on bowl and resecure with fasteners ensuring plastic washers are sandwiched between S.S. flat washers and ceramic bowl. Invert toilet and snap plastic nut caps onto nuts. Reinstall toilet on mounting surface, connect hoses and secure with hose clamps.