



**2003
Owner's Manual**

RECORD IMPORTANT INFORMATION

In addition to this manual, your Malibu Owner's Packet contains instructions, warranties and other important information from component manufacturers. Read these materials carefully since improper registration, operation and maintenance can void the warranty and jeopardize the safety of you and others. Fill in the information below and keep a copy of it in a safe place.

Hull

HIN _____

Ignition Key # _____

Registration # _____

Date Purchased _____

Dealer/Phone _____

Fax/E-mail _____

Engine

Model # _____

Serial # _____

Transmission

Model # _____

Serial # _____

Trailer

Model # _____

Serial # _____

Accessory

Model # _____

Serial # _____



All information and specifications included in this manual were in effect at the time of approval for printing. Malibu Boats West, Inc. reserves the right, however, to discontinue or change specifications or design at any time without notice and without incurring any obligation.

Trademarks

Malibu, The Malibu Logo is a registered trademark of Malibu Boats West, Inc.

Indmar, Indmar is a registered trademark of Indmar Products Co., Inc.

All other product names are copyright and registered trademarks/trade names of their respective owners.

© 2000, 2001, 2002, 2003 Malibu Boats West, Inc. All Rights reserved.
Printed in the USA

CONTENTS

CONTENTS	iii	Swim Platform	2-12
TABLE OF FIGURES	iv	Navigational Lights	2-13
INTRODUCTION	v	Storage Areas	2-13
CERTIFICATIONS & STANDARDS ..	v	Drain Plugs	2-14
MODEL SPECIFICATIONS	vi	Speedometer Pickups	2-14
BOATING SAFETY	1-1	Tilt Steering Wheel	2-15
General Precautions	1-1	Exhaust	2-15
Safety Statements	1-1	Ventilation	2-16
Regulations	1-2	Optional Equipment	2-17
Responsibilities	1-2	Wedge	2-19
Emergencies	1-4	Warning Labels	2-20
Hazardous Conditions	1-5		
Carbon Monoxide	1-6	OPERATION	3-1
Operation By Minors	1-7	Trailering	3-1
Passenger Safety	1-7	Fueling	3-4
Basic Rules Of The Road	1-7	Starting	3-4
		Shifting/Running	3-6
FEATURES & CONTROLS	2-1	Steering	3-6
Standard Gauges	2-2	Stopping	3-8
Circuit Breakers	2-6	Docking	3-9
Switches & Indicators	2-7	High Speed Operation	3-10
Throttle Control	2-8	Towing A Skier	3-11
Steering System	2-9	Towing Another Boat	3-12
Emergency Engine Stop Switch	2-9	Anchoring	3-12
Bow Tonneau Cover	2-9	Propellers	3-13
Motorbox Cover	2-10	Corrosion Protection	3-14
Driver's Seat	2-10		
Integral Self Draining		CARE AND MAINTENANCE	4-1
Ice Chest	2-11	Interior	4-1
Sundeck	2-11	Exterior	4-1
V-Drive Engine Access		Engine/Drive Train	4-3
Hatch	2-11	Fuel System	4-5
Ski Pylon	2-12	Electrical	4-6
		Miscellaneous	4-8
		Troubleshooting	4-10
		Warranty Information	4-14
		Glossary	4-17
		Index	4-18

TABLE OF FIGURES

Figure 1-1 Personal Flotation Devices	1-3	Figure 2-21 Bow Light	2-13
Figure 1-2 Fire Extinguisher	1-3	Figure 2-22 Lockable Transom Storage	2-13
Figure 1-3 Weather Hazards	1-5	Figure 2-23 Transom Drain Plug	2-14
Figure 1-4 Diver Down Flag	1-5	Figure 2-24 Bilge Drain Plug	2-14
Figure 1-5 Carbon Monoxide Hazards	1-6	Figure 2-25 Thru-Hull Paddle Wheel Pickup	2-14
Figure 1-6 Regulatory Markers	1-8	Figure 2-26 Tilt Steering	2-15
Figure 1-7 Buoy Shapes	1-9	Figure 2-27 Heater	2-17
Figure 1-8 Spherical Marker	1-9	Figure 2-28 Bimini Top Screw	2-17
Figure 1-9 Day Markers	1-9	Figure 2-29 Strap Eyelet	2-17
Figure 1-10 Crossing Situation	1-10	Figure 2-30 Stereo Remote Control Panel	2-17
Figure 1-11 Overtaking Another Craft	1-11	Figure 2-31 Shower Head	2-18
Figure 2-1 General Layout V-Drive Boats	2-1	Figure 2-32 Shower Valve	2-18
Figure 2-2 General Layout Direct Drive Boats	2-1	Figure 2-33 Pull-Up Cleat	2-18
Figure 2-3 Tachometer/Hourmeter	2-2	Figure 2-34 SaniPottie	2-18
Figure 2-4 Speedometer Calibrate and Display Selection Switches	2-2	Figure 2-35 Wedge Down	2-19
Figure 2-5 Speedometer	2-2	Figure 2-36 Wedge Up	2-19
Figure 2-6 Multi Gauge	2-5	Figure 2-37 Warning Labels	2-20
Figure 2-7 Circuit Breaker Panel	2-6	Figure 3-1 Trailer Hitch	3-1
Figure 2-8 Accessory Switch Panel	2-7	Figure 3-2 Safety Chains	3-2
Figure 2-9 V-Drive Warning Light	2-8	Figure 3-3 Bow Tie-Down	3-2
Figure 2-10 Throttle	2-8	Figure 3-4 Transom Tie-Down	3-2
Figure 2-11 Stop Switch Lanyard	2-9	Figure 3-5 Fueling	3-4
Figure 2-12 Motorbox	2-10	Figure 3-6 Throttle Positions	3-6
Figure 2-13 Bolster Seat	2-10	Figure 3-7 Turning With A Rudder	3-7
Figure 2-14 Lumbar Adjuster	2-10	Figure 3-8 Stern Push	3-8
Figure 2-15 Seat Adjuster	2-10	Figure 3-9 Docking With Wind/Current	3-9
Figure 2-16 Sundeck	2-11	Figure 3-10 Hand Signals	3-12
Figure 2-17 Engine Access Hatch	2-11	Figure 3-11 Towing	3-13
Figure 2-18 Pivoting-Head Ski Pylon	2-12	Figure 3-12 Propeller	3-14
Figure 2-19 Swim Platform	2-12	Figure 4-1 Typical Transmission Dipstick	4-4
Figure 2-20 Swim Platform Pins	2-12	Figure 4-2 Main Circuit Breaker	4-6
		Figure 4-3 Battery Level	4-7

INTRODUCTION

Over the years, you have watched us grow into one of the most respected boat builders in the world. And undoubtedly, somewhere, you have run into at least one Malibu owner who proudly speaks of the “Malibu Difference.” That difference they so proudly speak of could be the special way we have serviced them over the years. We call it “going the distance.” Or maybe they are referring to the way their Malibu consistently outperforms other ski boats that they have driven. We can’t deny that we are different. Our passion for building the perfect ski boat is only surpassed by our commitment to total customer satisfaction.

This manual has been assembled to help you operate your new Malibu with safety and pleasure. Details of typical equipment as well as recommended safety and maintenance procedures about your boat are supplied. Please read carefully and familiarize yourself with the craft before using it.

We at Malibu Boats thank you for choosing us as your boat manufacturer and assure you that your satisfaction and boating enjoyment will continue to be our #1 priority.

CERTIFICATIONS & STANDARDS

NMMA Certification

Your Malibu boat has been built to meet or exceed the standards set by the National Marine Manufacturers Association (NMMA). NMMA verifies annually, or whenever a new boat model is introduced, to determine that they meet not only Coast Guard regulations, but also the more comprehensive standards set by the American Boat & Yacht Council (ABYC).

Standards To Which This Boat Was Built

Your Malibu boat was built with the utmost care throughout the complete manufacturing process. The deck, hull, stringers and floor, as well as many accessory components, were built using our hand-laid composite fiberglass scheduling techniques. All boats receive complete quality control checks. Each boat is lake tested, and all information is kept on file at our factory for future reference.

Hull Identification Number (HIN)

Your Hull Identification Number can be found on the starboard transom of your boat below the rubber rub rail. Federal law prohibits the tampering or removing of the number in any way. Use this number to register your boat with your local and state authorities.

US MB2GXXXXA001

MODEL SPECIFICATIONS

	Sportster Series	Response Series	Response LXi	Wakesetter	Sunsetter/Wakesetter 21 XTi
Length	20'	20'	20' 6"	21'	21'
Beam	86"	90"	93"	93"	93"
Draft	14"	16"	16"	18"	18"
Weight	2100 lbs.	2450 lbs	2800	2800 lbs	2800 lbs
Fuel Cap.	38 Gal.	35 Gal.	41	41 Gal.	37 Gal.
Seating Cap.	6/8	6/8	8	10	10
Std. Engine	310 Vortec	310 Vortec	Vortec	310 Vortec	310 Vortec
Std. Gelcoat	3	4	3	3	3
Std. Prop.	3 Blade ACME	3 Blade ACME	3 Blade ACME	3 Blade ACME	3 Blade ACME
	Sunsetter LXi	Sunscape/Wakesetter 21 LSV	Sunscape/Wakesetter 23 LSV	Sunsetter/Wakesetter XTi	Sunscape 25
Length	21'8"	21'	22'6"	22'6"	25'
Beam	93"	93"	96"	96"	102"
Draft	18"	18"	24"	24"	26"
Weight	2900 lbs.	2900 lbs	3400 lbs.	3300 lbs.	4500 lbs.
Fuel Cap.	35 Gal.	35 Gal.	55 Gal.	43 Gal.	80 Gal.
Seating Cap.	10	11	12	12	14
Std. Engine	310 Vortec	335 Monsoon	335 Monsoon	335 Monsoon	8.1Liter / 425 HP
Std. Gelcoat	4	4 / 3	4 / 3	4 / 3	3
Std. Prop.	3 Blade ACME	4 Blade ACME	4 Blade ACME	4 Blade ACME	4 Blade ACME

Chapter 1

BOATING SAFETY



At Malibu, safety is not an option!

General Precautions

Your Malibu boat has been constructed to meet all U.S. Coast Guard and National Marine Manufacturers Association (N.M.M.A.) requirements. However, it is still your responsibility as the boat owner to ensure the boat is always operated in a safe fashion.

U.S. Coast Guard regulations require certain safety equipment be present on your boat during operation. Besides the U.S. Coast Guard regulations, other local and/or international law enforcement agencies may have similar requirements. You should check with your local marine enforcement agency regarding any such requirements before using the waterways.

It is not intended for this manual to be a replacement for a course on boating safety. It is highly recommended that if you are unfamiliar with the use and operation of a boat, you seek advice and training from a qualified individual or organization. Check with your local boating agency or Malibu dealer for more information about boating safety classes in your area.

Safety Statements

Throughout this manual, specific precautions and symbols identify safety related information. Follow these precautions as indicated.



The Safety Alert symbol means Attention! Become Alert! Your Safety Is Involved!

DANGER



Indicates the presence of a hazard which WILL cause SEVERE injury, death or substantial property damage.

Warning



Indicates the presence of a hazard which CAN cause SEVERE injury, death or substantial property damage.

Caution

Indicates the presence of a hazard which WILL or CAN cause MINOR or MODERATE personal injury or property damage.

Notice: Indicates installation, operation or maintenance information which is important but not hazard related.

The precautions listed in this manual and on the boat are not all-inclusive. If a procedure or method is not specifically recommended, you must satisfy yourself that it is safe for you and your passengers, and that the boat will not be damaged or made unsafe as a result of your decision. **Remember — always use common sense when operating your boat!**

Regulations

The U.S. Coast Guard is the governing authority of the waterways and is there to help the boating public. State boating regulations are enforced by local authorities. You are subject to marine traffic laws and “Rules of the Road” for both federal and state waterways; you must stop if signaled to do so by enforcement officers and permit to be boarded, if asked.

Responsibilities

Registration

Federal Law requires that all motorboats be registered and that all motorcraft not documented by the U.S. Coast Guard display registration numbers. In nearly all states, this means registration with the designated state agency. In a few jurisdictions, the Coast Guard retains registration authority. Your Malibu dealer will either supply registration forms or tell you where they may be obtained. The agency will supply you with a certificate which must be carried with you when the boat is in operation.

Education

If you have never owned a boat before you can get an excellent introduction to boat handling from organizations such as the U.S. Coast Guard and American Red Cross. Even if you are a veteran boater, these courses will help sharpen your boating skills as well as bring you up to date on current rules and regulations. See your local boating agency or Malibu dealer for information on classes in your area.

Insurance

The boat owner is legally responsible for damages or injuries he or she causes. Common sense dictates that you carry adequate personal liability and property damage insurance on your boat, just as you would on your automobile. You should also protect your investment from physical damage or theft.

Safety Equipment

U.S. Coast Guard regulations require certain accessory equipment on each boat. For a detailed description, obtain "Federal Requirements for Recreational Boats" published by the Coast Guard.

- 1) Personal Flotation Devices (PFDs): PFDs must be Coast Guard approved, in good and serviceable condition and the appropriate size for the user. It is recommended that you wear PFDs while your boat is underway.

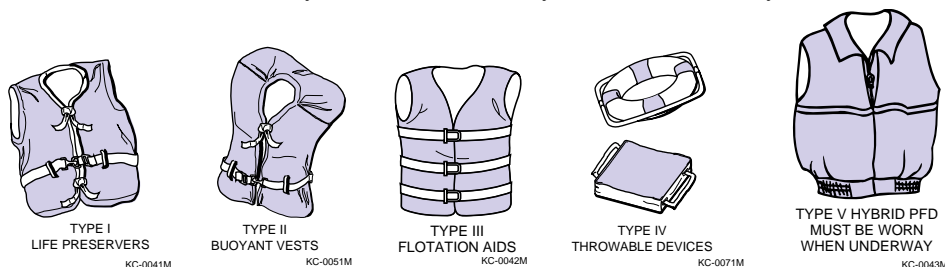

Figure 1-1. Personal Flotation Devices

Boats more than 16 feet in length must be equipped with one type I, II, III or V and one type IV. PFDs are intended to save lives; you and your passengers should wear them while in the boat. Learn how to use them and adjust as necessary to make comfortable to wear. The type II PFD is recommended for near shore or inland water use. Some PFDs are specially made for use while waterskiing and can handle impacts if a skier has fallen.

Notice: If a type V PFD is to be counted toward the minimum carriage requirements, it must be worn.

- 2) Emergency Stop Switch: Factory installed lanyard emergency stop switch. It is highly recommended that you use this switch since it can prevent your boat from becoming a runaway. (See page 2-13 for specific use.)
- 3) Fire Extinguishers: A fire extinguisher is required if your boat has an inboard engine, or when fuel is stored in closed stowage compartments.

Approved fire extinguishers are classified by a letter symbol, either B-I or B-II with the B designating that the material will extinguish flammable liquids such as gasoline, oil, etc. B-I extinguishers are required for boats less than 26 feet in length. Check periodically to insure that the extinguisher is in working condition and fully charged.

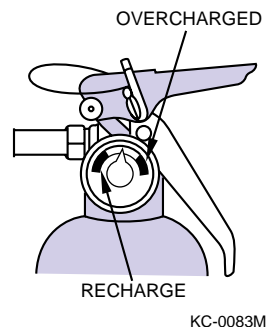

Figure 1-2. Fire Extinguisher

- 4) **Navigation Lights:** Recreational boats are required to display navigational lights between sunset and sunrise and other periods of reduced visibility (fog, rain, haze, etc.). Your navigation lights are provided to keep other boats informed of your presence and course. It is up to you to make sure they are operational and turned on when required.

Emergencies

Giving Assistance

Many of the distress calls are not true emergencies. In most cases the boat is disabled for one reason or another, but there is no immediate danger of death or serious injury. However, emergencies can occur and you should know how to cope with them. If you observe a boat in distress, assume it is a true emergency. Proceed to the scene and render assistance. Federal law requires boat operators to offer assistance and aid to others. The law's "Good Samaritan" clause absolves you from any civil liability in the event that your assistance causes injury or property damage.

There is a way to handle nearly every emergency if you don't panic. Learn your boating lessons and safety procedures well, and you will have the confidence and ability to handle an emergency should one arise.

Fires

Many boat fires involve flammable liquids such as gas or oil. Many inboard fires start in the bilge area which at times can be filled with gas vapors. Since gas vapors cannot be seen, boat fires tend to travel very fast. If you encounter a fire onboard, turn off the engine immediately. If you have a fire extinguisher onboard and access to the fire, it may be controllable. Direct the contents of the extinguisher at the base of the flames. Throw burning materials overboard if possible. Put on PFDs if not already on, signal for help and prepare to abandon the boat if necessary.

Reporting

Boat operators are required by law to file a Boating Accident report with their state boating law enforcement agency when their boat is involved in certain boating accidents. A boating accident must be reported if there is a loss or probable loss of life, personal injury requiring medical attention, damage exceeding \$500, or there is a complete loss of the boat. If any of these conditions arise seek further assistance from local law enforcement personnel.

Hazardous Conditions

Every waterway poses hazards that should be avoided. The following information outlines some of the hazards which may be encountered.

Weather

Learn and understand weather patterns and signs of change. Bad weather can cause an uncomfortable and unsafe situation. If a storm approaches seek a safe harbor.

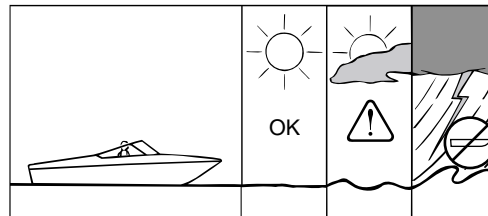

KC-0210M

Figure 1-3. Weather Hazards

Dam Spillways

The area around dam spillways is very hazardous and conditions can change rapidly. Stay clear of the spillways and areas below dams.

Weeds

Weeds can generally be a threat to a boat's engine and other components on the boat. If weeds wrap around the propeller they can create vibration in the engine. They also restrict water intake, causing the engine to overheat, and can clog speedometer pickup tubes, affecting correct speedometer readings.

Shallow Water Operation

Shallow water brings on obvious hazards such as sand bars, stumps, rocks, etc. Know the area you will be operating the boat in. Hitting objects at high speeds can cause severe damage to people and the boat. If you know you will be navigating the boat in shallow water, post a lookout and proceed slowly.

Know the minimal depth your boat can safely travel.

Caution | *Damage to underwater gear caused by shallow water maneuvering is not covered by your warranty.*

Warning Markers

Learn to recognize the different buoys and day markers; they are used as the signposts of the waterways identifying navigable routes and water hazards. It is a good idea to ask local authorities about hazard areas and if they are marked. Stay within boundaries and clear of hazards.

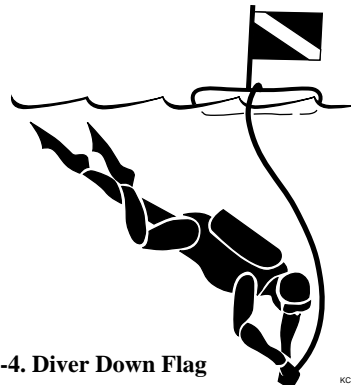

Figure 1-4. Diver Down Flag

KC-0250M

Carbon Monoxide

Carbon Monoxide (CO) is a colorless and odorless gas produced by all engines and fuel burning appliances. Even with the best boat design and construction, plus the utmost care in inspection, operation, and maintenance, hazardous levels of CO may still be present in accommodation spaces under certain conditions. To reduce CO accumulation, always ventilate the boat interior and avoid boating situations which cause increased exposure.

DANGER



EXTREME HAZARD – Carbon monoxide gas (CO) is colorless, odorless and extremely dangerous. All engines and fuel burning appliances produce CO as exhaust. Direct and prolonged exposure to CO will cause BRAIN DAMAGE or DEATH. Signs of exposure to CO include nausea, dizziness and drowsiness. Sources of CO include:

- ❶ Blockage of boat exhausts by obstruction.

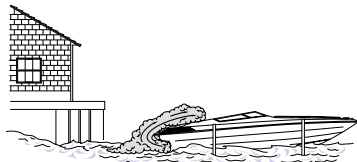

- ❷ Operating with high bow angle.



- ❸ Exhausts traveling along obstruction.

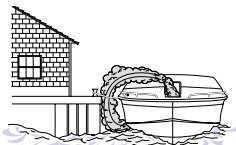

- ❹ Exhausts from other vessels in confined areas.



- ❺ Operating at slow speed or while dead in the water.



- ❻ Operating with canvas tops and side curtains in place without ventilation.



ENSURE ADEQUATE VENTILATION FOR CORRECT AIR MOVEMENT THROUGH BOAT!

KC-0461M

Figure 1-5. Carbon Monoxide Hazards

Operation By Minors

If your boat will be operated by a minor, remember to have an adult present at all times. Many states have laws regarding minimum age and licensing requirements for minors. Contact state and local authorities for special requirements that may apply in your area.

Passenger Safety

Any time you take your boat out, make sure that there is at least one other passenger aboard who is familiar with the operation of your boat. Passengers should be well aware of emergency equipment and shown how to use it. Passengers should also keep hands and feet in the boat and be safely seated while the boat is in motion.

Your boat should never be operated while you are under the influence of alcohol or drugs. Reaction times can be reduced and judgment affected creating situations that can be very dangerous.

Warning



Federal and state laws prohibit operating a boat under the influence of alcohol and other drugs. These regulations are actively enforced. Impaired operation may result in severe personal injury or death.

Basic Rules Of The Road

Warning



The nautical rules of the road must be followed to prevent collisions between vessels. Like traffic laws for automobiles, the operator is legally required to follow the rules.

The following information outlines only the most basic of the nautical rules of the road. For more information, contact your local U.S. Coast Guard Auxiliary.

Aids to Navigation

Learn to recognize the different buoys and day markers; they are the signposts of the waterway. There are 2 primary marking systems in use in the U.S.: the Uniform State Waterway Marking System (USWMS) used on inland waters and maintained by each state, and the Federal Waterway Marking System (FWMS) used on coastal waters and rivers and maintained by the U.S. Coast Guard (USCG). In addition, the FWMS has two modified systems; Western River Buoyage, and Intracoastal Waterway Buoyage. Be sure to check with local authorities on the buoyage system in use.

The type of hazard/warning buoys and markers depends on the area of jurisdiction. Check with local boating authorities.

USWMS System

In the USWMS Lateral System, well defined channels are marked with red and black buoys. Lateral means the sides of the channel are marked and the boat should pass between them.

The USWMS Cardinal System is used when there is no well defined channel or where an obstruction may be approached from more than one direction. With the cardinal system:

- Pass north or east of BLACK-TOPPED WHITE buoy.
- Pass south or west of RED-TOPPED WHITE buoy.
- RED and WHITE VERTICALLY STRIPED buoy indicates boat should pass outside of the buoy (away from shore).

Uniform State Regulatory Markers

USWMS regulatory markers are white with international orange geometric shapes; you must obey regulatory markers.

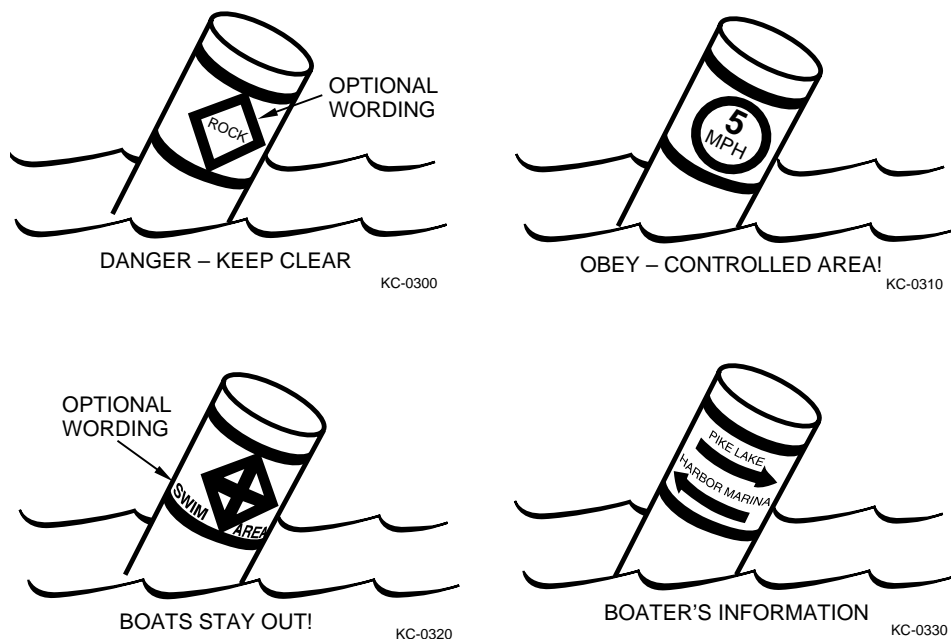

Figure 1-6. Regulatory Markers

FWMS System

The FWMS Lateral System is for use on navigable waters except Western Rivers and Intracoastal Waterways.

The markings on these buoys are oriented from the perspective of being entered from seaward (the boater is going towards the port). This means that red buoys are passed on the starboard (right) side of the vessel when proceeding from open water into port, and green buoys to the port (left) side.

The right side (starboard) of the channel is marked with RED, even numbered buoys. The left (port) side of the channel is marked with GREEN, odd numbered buoys.

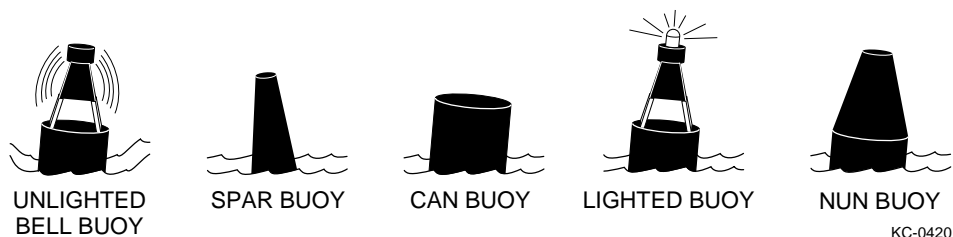

Figure 1-7. Buoy Shapes

The middle of the channel is marked with RED and WHITE vertically striped buoys; pass close to these buoys.

Obstructions, channel junctions, etc. are marked with RED and GREEN horizontally striped buoys.

A RED band at the top means the preferred channel is to the left of the buoy; a GREEN top band means the preferred channel is to the right of the buoy.



Figure 1-8. Spherical Marker

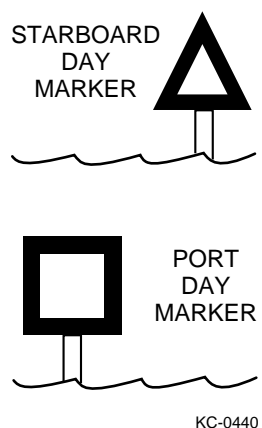

Figure 1-9. Day Markers

Day markers are colored and numbered the same as buoys. RED, triangular day markers with even numbers mark the starboard side of the channel. GREEN, square day markers with odd numbers mark the port side of the channel.

Lights, bells and horns are used on buoys for night or poor visibility conditions.

Right-Of-Way

Notice: In general, boats with less maneuverability have right-of-way over more agile craft. You must stay clear of the vessel with right-of-way and pass to his stern.

Privileged Boats

Privileged boats have right-of-way and can hold course and speed. Sailboats and boats paddled or rowed have the right-of-way over motor boats. Sailboats under power are considered motorboats. Small pleasure craft must yield to large commercial boats in narrow channels.

Burdened Boats

The burdened boat is the boat that must make whatever adjustments to course and speed necessary to keep out of the way of the privileged boat.

Crossing Situation

In crossing situations, the boat to the right from the 12 o'clock to the 4 o'clock position has the right-of-way. It must hold course and speed. The burdened boat keeps clear and passes behind the privileged boat. Boats going up and down a river have the privilege over boats crossing the river.

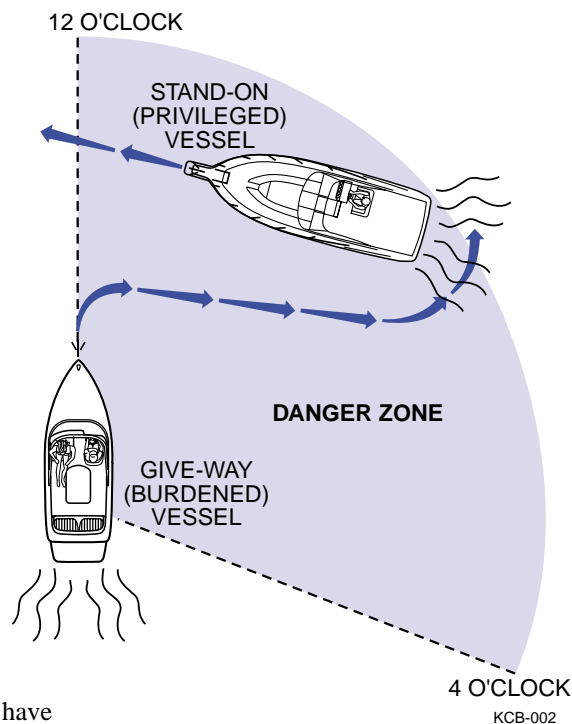

Figure 1-10. Crossing Situation

Meeting Head-On

Neither boat has the right-of-way in this situation. Both boats should decrease speed, should turn to the right, and pass port-to-port. However, if both boats are on the left side of a channel, each vessel should sound two short horn blasts and pass starboard to starboard.

Overtaking

The boat that is overtaking one ahead of it is the burdened boat and must make any adjustments necessary to keep out of the way of the privileged boat.

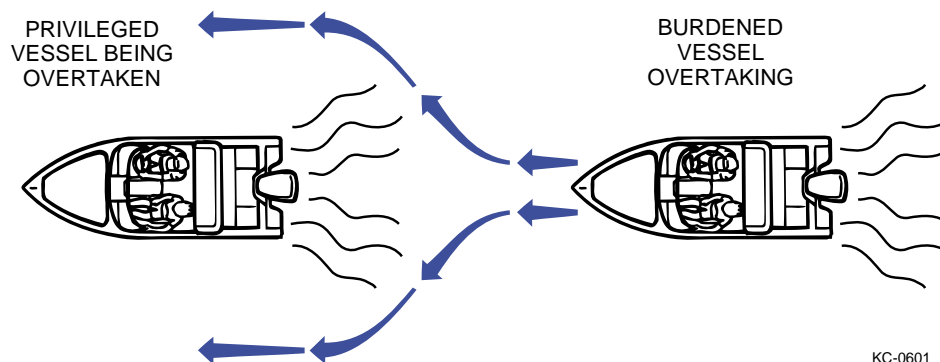

Figure 1-11. Overtaking Another Craft

The General Prudential Rule

The general prudential rule regarding right-of-way is that if a collision appears unavoidable, neither boat has right-of-way. As prescribed in the Rules of the Road, both boats must act to avoid collision.

Night Running

Boats operating between sunset and sunrise (hours vary by state) must use navigational lights. Nighttime operation, especially during bad weather or fog can be dangerous. All Rules of Road apply at night, but it is best to slow down and stay clear of all boats, regardless of who has right-of-way. Protect your night vision by avoiding bright lights and have a passenger, if possible, help keep watch for other boats, water hazards, and aids to navigation.

Chapter 2

FEATURES & CONTROLS



No other ski boat manufacturer incorporates in their product as many innovative and technically advanced features as Malibu.

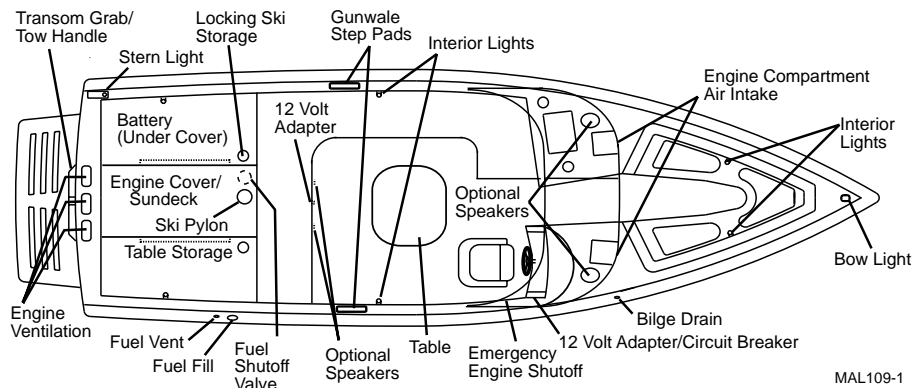

Figure 2-1. General Layout V-Drive Boats

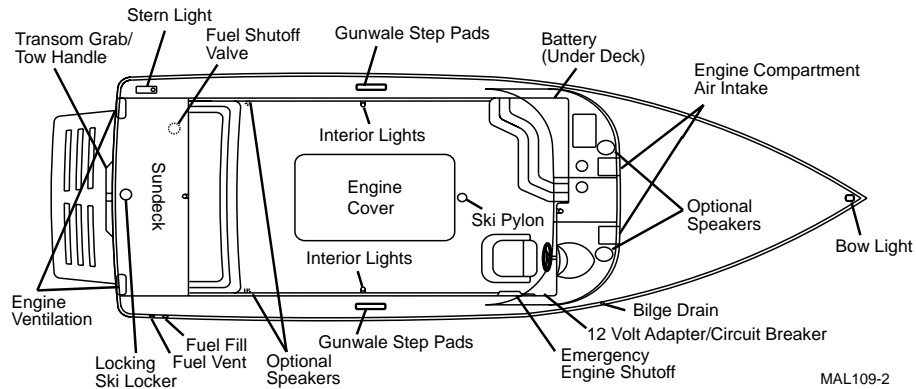

Figure 2-2. General Layout Direct Drive Boats

Standard Gauges

The following standard gauges are included on all models. It is important for the safe and proper operation of your boat to fully understand these gauges.

Tachometer

Located top right of the dash panel the tachometer registers the operating speed of your engine in revolutions per minute (RPM). This gauge is used to provide you with information needed to ensure the operation of the engine is kept within engine manufacturer's proper range of operation. Be sure to consult your engine manual for the correct range of operation for your particular model.



Figure 2-3. Tachometer/Hourmeter

Caution

Do not operate the engine with the tachometer in the red area. Your engine or other parts could be damaged. Damage caused to your engine or boat due to operation of the engine in the red area may not be covered by your engine warranty.

Speedometer

The speedometer registers speed in miles per hour (MPH). The speedometer system consists of a thru-hull paddle wheel speed sensor that records water movement, a computer located under the dash that converts the information, an analog readout on the dash, and the inter-connecting wiring. The speedometers are calibrated at the factory and will not normally need additional adjustment, however, from time to time it may be necessary to re-calibrate. The speedometers can be adjusted using the SPEEDO rocker switch located to the right of the steering wheel. Please refer to Speedometer Calibration below for the adjustment procedure.



Figure 2-4. Speedometer Calibrate and Display Selection Switches



Figure 2-5. Speedometer

Speedometer Calibration

To quickly recalibrate to AWSA official tournament rules, you will need an accurately measured ski course of 850 feet and a certified stopwatch accurate to a thousandth of a second.

1. Approach the course at a speed of 36 MPH. Hold the speed steady and have observer check the course with the stopwatch as you pass through the beginning of the course.
2. The course time should be between 15.88 and 16.28 seconds. No adjustments are necessary if within this tolerance.
3. If the course time is not within this tolerance, adjust the rocker switches up or down until you are calibrated.

Multi Function Display Panel

Located in the lower panel of the speedometer gauge is an LCD display panel that allows an assortment of standard and optional features to be displayed. To find each feature, scroll through the screens by depressing the up arrow of the DISPLAY rocker switch found to the right of the steering wheel, until desired feature is located. Each function will stay displayed until another is chosen.

Notice: Use only the up arrow to scroll through each feature, do not use the down arrow. The down arrow is used to adjust the functions of the feature chosen. Below is a list of standard and optional features that can be displayed.

Feature 1: Digital Clock Display

Set to display current time. To adjust, press and hold the down arrow of the DISPLAY switch for three seconds or until the colon (:) stops flashing. Continue to hold button down until correct hours are set. Press the up arrow to set minutes. One push of the button will set time by one minute increments, holding the button will set the minutes by ten minute increments. No change for three seconds will revert the clock to standard operation.

Feature 2: Hour Meter Display

Notice: Hours only accumulate when engine is above 300 rpm.

The hour meter acts as an odometer for the engine. Use the hour meter to identify how much your boat is being used and what time you will need to perform required and recommended maintenance at the proper intervals. No adjustment function is available for this feature. Please refer to your engine manual to determine maintenance schedules.

Feature 3: Optional Water Depth Display

The optional water Depth feature will aid in finding shallow areas of water that may cause damage to your boat if hit. The gauge will display the depth of the water relative to the bottom of the boat and may also be programmed to sound an alarm at a pre-determined depth. To check the depth of the water, use the up arrow of the DISPLAY rocker switch to scroll to the Depth feature; the current depth will be displayed.

The unit comes from the factory with the alarm setting programmed to “0”. To change the alarm depth, press and hold the down arrow of the DISPLAY rocker switch three (3) seconds or until current depth alarm set point is displayed. Press and hold the up arrow on the rocker switch to set desired alarm depth. An audible alarm will sound if you travel within the set alarm depth. No change for three seconds will revert the Depth Gauge to standard operation.

Feature 4: Air Temperature Display

The Air Temperature feature displays the ambient air temperature and is measured in degrees Fahrenheit only. No adjustment function is available for this feature.

Feature 5: Lake Temperature Display

The Lake Temperature feature provides lake water temperature, and is measured in degrees Fahrenheit only. No adjustment function is available for this feature.

Feature 6: Optional Global Position System (GPS) Display

The optional GPS feature has two modes; Compass Mode will aid in determining geographical location by displaying coordinates of longitude and latitude, and Speed Mode to set speed based on the coordinate settings.

Compass Mode

Compass Mode is used to give directions in North, South, East and West. The orientation for this feature is completed at the gauge manufacturer, and no adjustment is necessary.

Speed Mode

Displays the GPS speed with an update rate of once per second.

Speed Auto Cal

The speedometer can be calibrated automatically when the boat speed is between 15 and 36 MPH. To calibrate, select the GPS feature display. Press and hold the down arrow of the DISPLAY rocker switch for three (3) seconds until “CAL” is displayed. Continue to hold button down until the display reads “DONE” or “FAIL”. If the LCD reads “DONE”, the speedometer will automatically adjust to GPS speed. The LCD reads, “FAIL” for the following reasons:

1. GPS speed was not within 15 - 36 MPH.
2. GPS was not steady ± 3 MPH for 3 seconds.

GPS Failure Signals

If the GPS module is attached, but the LCD does not display, there is a problem with the wiring or module. Please contact your local Malibu dealer for servicing.

If GPS fails during operation, it will display “NORES”, no response. Please contact your local Malibu dealer for servicing.

If GPS module does not lock on to a GPS signal, the LCD will read “NOSIG”, no signal.

Multi Gauge

This single gauge combines the functions of four individual gauges for quick monitoring at-a-glance.

- **Temperature Gauge**

The Temperature Gauge indicates the temperature of the water/coolant inside the engine. The proper operating range for your engine is between 140-160 degrees Fahrenheit. Engines equipped with the optional Monsoon engine have a control in the engine control module that will cause the engine to run at reduced speeds if the module senses that the engine is running too hot. If you notice that your speed has reduced during normal operation without reducing the throttle, monitor your temperature gauge. If your gauges indicate excessive temperatures during operation, slow down immediately and turn off engine.

Continuing to operate the boat while the temperature is above normal operating parameters may cause serious damage to your engine.



Figure 2-6. Multi Gauge

- **Voltmeter Gauge**

The voltmeter indicates whether the battery is charging or discharging. The needle should be in the normal range (approximately 14 volts) while the engine is running. Readings in either warning zone indicate a possible problem in the electrical system.

- **Fuel Gauge**

The fuel gauge indicates the quantity of fuel remaining in the tank when the ignition is in the "ON" position. Although your fuel tank will still have some fuel remaining even though the gauge reads empty, it is recommended that the tank be filled when the gauge indicates 1/4 full.

Warning | Do not top off tank!



Notice: It is not uncommon during the operation of your boat for the fuel gauge to register slightly different amounts than what is actually in the tank. This is normal operation and does not indicate a problem.

For more information on fueling your boat, see "Fueling" under the "Operation" section of this manual.

- **Oil Pressure Gauge**

The oil pressure gauge indicates the oil pressure in the engine while the engine is running and is measured in pounds per square inch (PSI). Oil pressure may vary with engine speed, outside temperatures, oil viscosity, and other environmental factors, but readings above the low pressure zone indicate the normal operating range. If the oil pressure reading is below the normal range, you should stop the engine immediately and check your oil as soon as possible.

Average pressure ranges are between 6 PSI at 1000 RPM and 40 PSI at cruising speeds. If you are experiencing low oil pressure, stop your engine immediately and check your oil level before operating again.

Warning



Do not continue to run engine if pressure is low. If you do, the engine can become so hot that it or surrounding components could catch on fire.

Notice: Damage caused from neglected oil problems can be costly. Such damage is not covered by your warranty.

Circuit Breakers

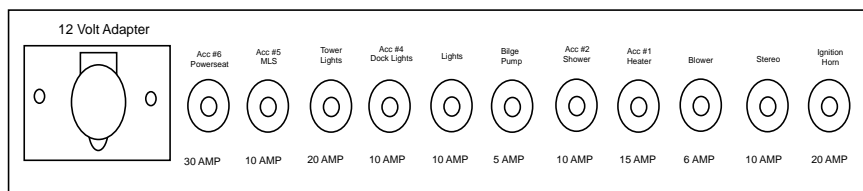

MAL109-9

Figure 2-7. Circuit Breaker Panel

All major boat circuits are protected from shorting and overload by resettable circuit breakers. If a problem develops with one of the following circuits, switch off the circuit and wait about one minute. Then push the appropriate breaker button fully and switch on the circuit. If the circuit continues to trip, there is a problem somewhere in the system. See your dealership immediately to locate the problem.

Switches & Indicators

Accessory Switch Panels

These panels are located in the dash directly below the standard gauges and are used to activate the following features. You will find the feature or accessory provided within each button face for description.

- Horn
- Navigation Lights
- Interior Lights
- Accessory Docking Lights
- Accessory Tower Lights
- Accessory Shower
- Accessory Heater
- Accessory Malibu Launch System (MLS)
- Accessory Stereo
- Bilge Pump
- Blower

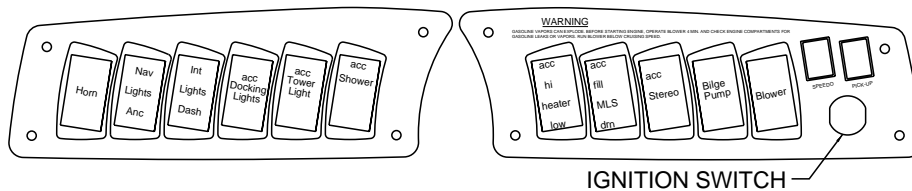

MAL109-10

Figure 2-8 Accessory Switch Panel

Bilge Pump

The bilge pump switch is used to activate the bilge pump so that any excess water in the bilge area may be drained out. You should know that the bilge pump has a sensor in the bilge area and will turn on automatically whenever two inches or more of water is detected.

Blower

This switch activates the blower for the engine compartment. The primary function of the blower is to eliminate any fumes in the motor compartment when starting the engine or during idling.

Warning



Gasoline Vapors Can Explode. Before starting engine, operate blower for 4 minutes and check engine compartment for gasoline leaks or vapors. Run Blower below cruising speed.

Stereo

This switch must be on for your stereo to have power. Please see the stereos owner's manual for operating instructions.

Accessory #1

This switch is used to supply power to the optional heater unit. (For information on the heater use, please see heater operation in the optional equipment section of this manual.)

Accessory #2

This switch is used to supply power to the optional hot water shower. (For information on the use of the hot water shower, please see hot water shower usage in the optional equipment section of this manual.)

Interior Lights

This switch is used to activate the interior lights. The interior lights include lights in the gunnels, storage compartments, and dashboard.

Navigational Lights

In the ANC (anchor) position, this switch is used to activate the stern light. Keep the stern light on after dusk whenever your boat is at rest in the open waterway. While underway, place the switch in the RUN position to also activate the red and green navigation bow lights.

V-Drive Warning Light

The V-Drive Warning Light is located in front of the throttle on V-Drive model boats and is a warning device used to safeguard against low V-Drive fluids, which could result in overheating the unit and eventual failure.

If the light is on above 1200 RPM, the oil pressure is low. Check V-Drive oil. (Check while cool.) If the problem persists, see your local Malibu dealer.



MAL109-11

Figure 2-9. V-Drive Warning Light

Throttle Control

The throttle lever is located to the right of the driver. When the throttle is vertical, it is in the “NEUTRAL” position. At the base of the throttle you will find the shift lock. Pulling outward on this button disengages the transmission, thereby allowing use of the throttle without engaging the transmission. This is needed for starting or warm-up of the engine. Be sure to position the throttle vertically (in “NEUTRAL”), before re-engaging the transmission, by depressing the button.



Figure 2-10. Throttle

When engaging the transmission from “NEUTRAL” to either forward or reverse, you must pull up on the safety collar located directly below the throttle lever knob.

Warning | *Before starting engine or engaging transmission, ensure all swimmers are out of the water.*



For more information regarding the safe operation and maintenance of the throttle control, refer to the separate instructions located in the information packet shipped with your boat.

Steering System

It is important that you get the “feel” of your Malibu boat’s steering system. Turn the wheel from full left to full right, and make sure the rudder is turning accordingly. The system should operate freely and smoothly.

Notice: **It is normal for your Malibu steering to pull slightly to the right under normal driving conditions. The boat will pull straight while skier is under tow.**

Emergency Engine Stop Switch

The emergency engine stop switch attaches to the driver of the boat and shuts down the engine if the driver of the boat is accidentally forced away from the helm.

The switch consists of a helm-mounted switch plunger and a switch clip/lanyard clip, which is connected between the stop clip and the operator. Should the operator move away from the controls, the clip pulls free, releasing the plunger and stopping the engine. If the engine must be shut down quickly, a pull on the cord to release the clip from the switch will stop the engine.



Figure 2-11. Stop Switch Lanyard

To reset the switch after activation, reinstall the switch clip.

Notice: **If lanyard switch is damaged or lost you can purchase a new switch through your local marina or Malibu dealer.**

Bow Tonneau Cover

The tonneau cover is available on all walk-through open bow boats and is available as an option on all other open bows. To install, begin at the bow of the boat attach snaps by snapping cover to the deck of the boat. Work towards the windshield and walk-through. Close the door on the windshield and attach snaps to the door, to remove simply reverse procedure.

Notice: The tonneau cover is not attached at the manufacturing facility unless specified during boat order. If you would like tonneau attached, please see your Malibu dealer.

Motorbox Cover

The upholstered motorbox reduces engine noise and provides protection for the passengers on board. To open, stand on the port side of the box near the observer seat, grasp the handle near the floor and pull open. The motor box is equipped with either one or two gas-filled shock absorbers (depending on model) to provide support for the compartment when opened.



Figure 2-12. Motorbox

Warning



Running the engine with the motor box open exposes rotating machinery which can cause injury to occupants of the boat.

Driver's Seat

The driver's seat can be adjusted forward and backward by pulling the lever located on front left side of the drivers seat. Pull lever outward and adjust seat as needed.

Lumbar Support

The driver's seat is equipped with a Lumbar Support. To adjust, locate the twist knob located on the left side of the seat bottom. Turn the knob clockwise to increase lean back tension, or counterclockwise to decrease tension.



Figure 2-13. Bolster Seat

Swivel Seat Base

Some models are also equipped with a swivel seat adjustment. To adjust the seat, release the lever directly below the front center of the drivers seat area by lowering to the bottom of the seat base. Locate the twist knob on the left center of the seat base, (this knob is different than the Lumbar Support) and turn counterclockwise to loosen. The seat should swivel freely. To re-set the seat position, simply reverse these steps.



Figure 2-14. Lumbar Adjuster



Figure 2-15. Seat Adjuster

Integral Self Draining Ice Chest

This item is available on most model boats and can be found either in the observer seat base, center floor or under bow cushion seating areas. The melted water will drain into the bilge area of your boat.

Sundeck

The passenger seats located in the rear of the boat are designed to comfortably seat three persons. Some models are equipped so the bottom seat can be slid forward and placed on top of the armrest to provide a sundeck. On other models the sundeck is built into the storage compartment cover.



Figure 2-16. Sundeck

Warning



The Sundeck is not to be used while the boat is in operation. Serious injuries or death could occur to persons not seated properly should the boat come to an abrupt halt.

V-Drive Engine Access Hatch

An engine access hatch is located behind the rear observers' seat on the V-Drive. Access allows the ability to service engine for required maintenance and for additional storage on both sides of the engine. Your boat battery will be stored in the starboard compartment.



Figure 2-17. Engine Access Hatch

Warning



Ensure the safety pins located in the storage compartment are inserted into the hatch assembly. Failure to do this could allow your engine hatch door to open while under way causing damage to your boat and others.

Ski Pylon

The patented, pivoting-head ski pylon is the solid aluminum post located directly in front of the motor box. Minimal maintenance is required, but once a year remove the swivel pylon head and re-grease with a high temperature bearing grease. This will increase use of the pylon and reduce normal wear and tear.

Warning



Malibu Boats' "Pivoting-Head" ski pylon is designed for normal water skiing activities: slalom, jumping, kneeboarding, tricks, and barefooting. Any other uses such as parasailing, kite flying, towing pyramids of skiers, etc., may over-stress the pylon and possibly cause personal injury and/or equipment damage.



Figure 2-18. Pivoting-Head Ski Pylon

Swim Platform

A removable swim step is located on the stern of the boat to provide easy access into and out of the water for boat skiers and swimmers. To remove, simply remove the pins located on each side the platform brackets, and depending on model either lift or slide back on platform. To replace reverse these steps.



Figure 2-19. Swim Platform



Figure 2-20. Swim Platform Pins

Navigational Lights

As required by the U.S. Coast Guard, all recreational vessels are required to display navigational lights between sunset and sunrise and other periods of reduced visibility. All Malibu Boats are equipped with bow and stern navigational lights.

The bow light located at the tip of the bow is two colored — red and green, and is used to keep others aware of your presence when operating your boat at night.



Figure 2-21. Bow Light

A covered two pronged connector can be found on the top of the transom. The stern light is plugged into this connector when needed and stored under the rear passenger seat when not in use.

Storage Areas

Bow Storage Area

Access to a large storage area located in the bow of all models is accessible by lifting the bottom-lifting strap of the observers' seat back. The size of the storage differs between open and closed bow versions. On all open bow boats. The seat cushions can be removed to provide additional storage.

Gunnel Ski Storage

Conveniently located on both sides of the boat, these storage areas are ideal for the storage of water skis, and other items.

Floor Ski Storage

Located on the floor between the driver's and observers' seats on open bow models with walk-through, is a panel that when lifted provides access to a large area that can be used primarily for storage of water skis. This area can also be used to store beverages, if desired.

Transom Storage

Some boat models are equipped with transom ski storage. Depending on the model, the storage is accessible from either the interior by lifting the observers' seat or from the transom swim platform by lifting the hatch cover. Most models are equipped with a locking device for the secure storage of your ski items.



Figure 2-22. Lockable Transom Storage

Drain Plugs

Transom Drain Plug

This plug is located in the center of the transom at the bottom edge, and is provided to allow for drainage of the bilge area, when needed.



Figure 2-23. Transom Drain Plug

Bilge Drain Plug(s)

A brass, T-handled, bilge drain plug is located in the engine compartment of all models. Location is normally directly below the drive-train unit. To access, lift motor box and look aft of the ski tow pylon, and forward of the engine. On the V-drive models, the T-handle can be found by lifting the rear passenger seat. The T-handle is located just below the V-drive unit.



Figure 2-24. Bilge Drain Plug

Warning



Be sure that both the transom and bilge drain plugs are securely in place before placing the boat in the water.

Speedometer Pickup

Your boat is equipped with a thru-hull paddle wheel speedometer pickup and can be found directly under the running surface of your boat. The paddlewheel measures the static water by rotation of the paddlewheel unit. See troubleshooting section of this manual for basic maintenance information.



Figure 2-25. Thru-Hull Paddle Wheel Pickup

Tilt Steering Wheel

The tilt steering wheel allows for maximum driver comfort. To adjust the height of the wheel, simply press down on the lever located under the wheel. Move the wheel to the position that is most comfortable. When the wheel is in the desired position, simply release the lever to lock the wheel in place.

Exhaust

The exhaust system is used to remove engine exhaust fumes. To ensure that your boat's exhaust system is working correctly, it is important that you inspect for exhaust leaks. The following information will allow you to check these systems. Keep in mind that you will be checking engine while turned on, and that you will need to take safeguards against getting yourself or others caught in the moving parts. Use extreme caution while performing this task.

- Turn engine off and disconnect the engine safety switch. Be sure the throttle shift control is neutral. The engine must be cool.
- Open the engine and visually check the exhaust system from the engine to the transom for obvious damage.
- Re-install engine safety switch and start the engine with engine compartment open. Check hose connections between the exhaust manifolds and the muffler for leakage.
- If leakage is apparent, tighten the hose clamps, being careful not to crimp the hose. See your Malibu dealer for parts and or service.

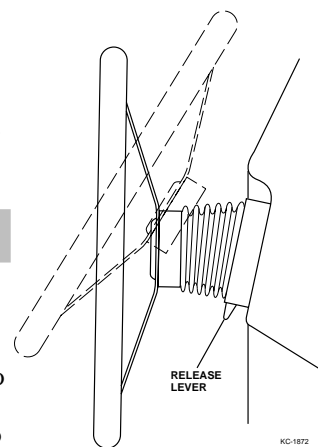

Figure 2-26. Tilt Steering

Ventilation

The ventilation is used to remove potentially hazardous accumulation of explosive vapors from the bilge areas of your boat's hull and engine compartment. Therefore, proper ventilation is essential to the safety of the boat and persons in or around the boat structure.

Your boat is equipped with a ventilation system that will ensure complete removal of these dangerous fumes. However, it is your responsibility as the operator of the boat to ensure these systems are working efficiently. The boat's primary source for expelling fumes from the boat is the blowers located in the bottom of the bilge and at the transom venting points. See Section 2, page 2-1.

Your boat is also equipped with a natural air-intake that forces air through a venting system on the deck of your boat, and channels air from the bilge to the transom vent.

Cooling

Most boats will be cooled with a continuous intake of lake water circulating it around engine components.

Closed Cooling System

If your boat is equipped with an optional closed cooling system, you will need to maintain correct fluid levels.

- Open engine compartment and remove reservoir cap.
- Ensure coolant is to the top of the reservoir filler neck.

Caution

***The engine must be cool when checking the coolant level.
Hot coolant and steam under pressure may cause injury.***

Optional Equipment

Heater

If your boat is equipped with a heater, you will find an ON/OFF accessory switch located on the dash panel. Located at the base of the observer seat walkway is a snorkel tube that can be pulled out and directed wherever you like within a five-foot radius. Please refer to the information provided in your owner's packet for specific use.



Figure 2-27. Heater

Bimini Top

For boats equipped with this option, attach the bimini top support legs to the wings on the side of the windshield. Place screw in each wing to hold in place. Attach adjustable strap to the eyelets located in the front and rear of the windshield, and adjust strap for tightness of the canvas.

The bimini top can be stored by releasing the adjustable strap, placing the canvas protective covering over the top, and then folding down the top to the front of the windshield.

For additional installation and assembly instructions, refer to the information that came with the bimini top.

Notice: If the canvas top is wet, allow to air dry before storing to prevent mildew.



Figure 2-28. Bimini Top Screw



Figure 2-29. Strap Eyelet



Figure 2-30. Stereo Remote Control Panel

Stereo

The optional stereo head unit is located under the driver's armrest. To access the stereo faceplate, simply lift the armrest. The faceplate can be removed for security purposes by depressing the upper right corner button.

To turn the stereo on, locate the STEREO rocker switch on the accessory switch panel, and push the rocker switch up. The stereo is equipped with a remote control panel, located to the right of the driver's seat, to adjust various stereo functions. A standard 3.5 mm stereo auxiliary input jack can be used with MP3/WMA players, computers, etc. Your boat may also be equipped with a second optional remote control panel located at the transom of your boat. For specific stereo use, please refer to your Stereo Manual that was included in your Owner's Packet.

If your boat was equipped with optional sound equipment to include CD Changer, Amplifier, or Subwoofer, please refer to these manuals included in your Owner's Packet for their specific use.

Hot Water Shower

If your boat is equipped with a hot water shower, you will find an ON/OFF accessory switch located on the dash panel. You will find the valves located on the port side of the motorbox compartment. The shower head can be found in the port gunnel sides. You should find specific instructions on the use of your hot water shower in the packet of materials you received with your boat.

**Figure 2-31. Shower Head****Figure 2-32. Shower Valve****Pull-Up Cleats**

Pull-Up cleats are available for all boat models. These cleats will sit flush on the side of the boat deck when depressed. To pull up the cleats, simply press the screw/button located in the center of the cleat. To depress the cleat, simply press the cleat downward until it locks into place.

**Figure 2-33. Pull-Up Cleat****Docking Lights**

The docking lights should only be used during slow speed docking maneuvers. The lights are activated by a switch on the accessory switch panel and have a 10 amp circuit breaker. Bulb access is through the lens cover outside the boat.

Port-a-Potty/SaniPottie (Sunscape 25 model boats only)

The portable port-a-potty provides simple and convenient disposal of waste for use in your boat while on the water. Before using the optional Port-a-Potty toilet, refer to your owner's manual that came in your owner's packet for complete operating instructions.

Pump-Out-Port-a-Potty

Also available as a secondary option is the Port-a-Potty, available as an upgrade to the standard SaniPottie. The unit can be cleaned via a 1-1/2" deck drain that will fit most marinas' pump-out facilities.

**Figure 2-34. SaniPottie**

Wedge



Figure 2-35. Wedge Down



Figure 2-36. Wedge Up

Wedge

If your boat is equipped with the Wedge option you will find that the unit has two positions - DOWN or UP. To adjust wedge position, access wedge through the swim platform door. To install in either position follow these steps:

DOWN - To lower unit, depress spring-loaded pins and lower until you hear Wedge pins engaged.

UP - To raise unit, reverse procedure.

Caution | *Ensure both spring loaded pins are engaged before taking off.*

Warning | *Excessive speeds over 30 MPH could cause adverse handling conditions. It is recommended that you put the Wedge unit in the UP position if you will be traveling over these speeds.*



Optional Malibu Launch System (MLS)

The optional MLS is a water ballast system that allows water to be stored onboard and to increase hull weight for larger wakeboard wakes. Depending on boat model, the MLS can be available as front and rear storage units. If your boat is equipped with this optional feature, locate the MLS drain and fill rocker switch on the accessory switch panel and press the switch up to fill ballast, or down to drain ballast.

Bow Tonneau Cover

The tonneau cover option is available on all open bow boats. This feature is standard on the Escape and Wakesetter models. However, unless specified, it will not be installed. You can contact your local Malibu dealer to have installed. To attach the cover, begin at the bow and attach snaps by pressing onto deck. Work toward windshield and walk through. Close door and attach snap to back side of door. To remove, reverse these steps.

Warning Labels

Warning labels are displayed at various locations throughout your new Malibu to point out safety hazards. It is important that you take the time to locate these labels. Do not remove or cover warning labels. Replace when illegible.

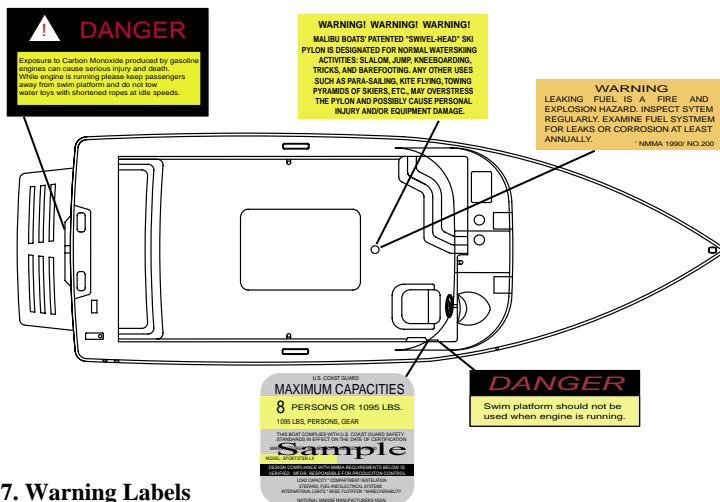

Figure 2-37. Warning Labels

MAL109-16

Load Capacity

The U.S. Coast Guard requires that boats under 20 feet have a certification plate stating the number of persons and maximum weight a boat will handle safely under normal conditions. The certification is attached near the helm forward of the throttle. Overloading is a violation, do not carry more weight or passengers than indicated on the plate. The presence of the plate does not relieve the owner/operator from responsibility for using common sense and sound judgment.

Caution | *Never exceed the load capacity and distribute weight evenly between bow and stern, and port to starboard.*

Caution | **SWAMPING HAZARD**
Overloading may reduce the stability and seaworthiness of the boat.

- The weight of all persons and gear including ballast bags, water bladders ballast tanks and fat sacks should never exceed the U.S. Coast Guard Maximum Weight Capacity listed on the capacity label.
- When determining the total weight on board, calculate the weight of water at nine pounds per gallon. Be sure to add the weight of the water to the weight of the persons and gear.

Chapter 3

OPERATION

Everyone benefits from the safety of others.



Trailer

The trailering information contained in this section describes general guidelines and procedures used by many boaters. We recommend, in addition, that you always follow the specific information provided by the manufacturer of your trailer.

Load Carrying Capacity

The certification label attached by the manufacturer on the left forward side of the trailer will show the maximum load carrying capacity of the trailer. The label is required to show the Gross Vehicle Weight Rating (GVWR), which is the load carrying capacity plus the weight of the trailer itself. Be sure that the total weight of your boat, gear, and trailer does not exceed the GVWR.

Notice: Consult your trailer dealer for other state regulations concerning brakes, lighting, and other equipment options.

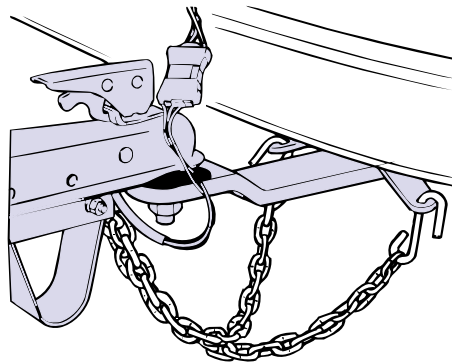

Figure 3-1. Trailer Hitch

KC-1700

Most boat trailers connect to a ball hitch that is bolted or welded to the towing vehicle. Clamp-on bumper hitches are not recommended.

The trailer hitch coupler must match the size of the hitch ball. Never use a hitch ball that does not match the trailer coupler. The correct ball diameter is marked on the trailer coupler.

Hitch

Hitches are divided into classes that specify the gross trailer weight (GTW) and maximum tongue weight for each class. Always use a hitch with the same class number as the trailer, or greater.

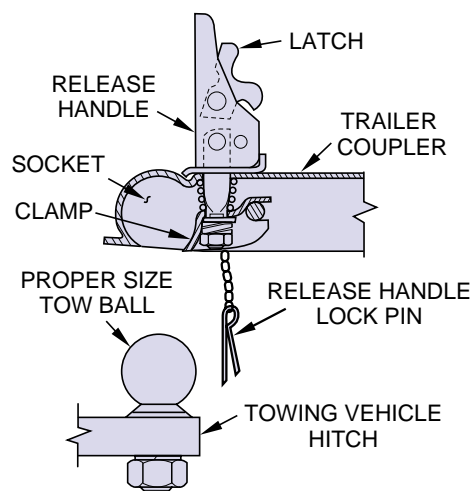

KC-1651

Safety Chains

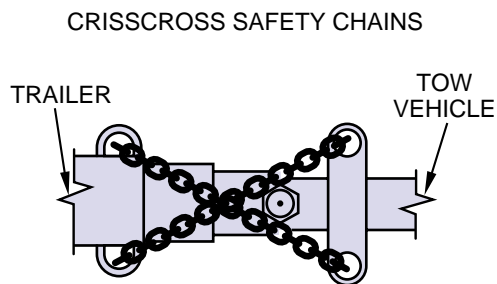

BOTTOM VIEW OF HITCH COUPLING

KC-1691

Safety chains on your boat trailer provide added insurance that it will not become completely detached from the towing vehicle when underway.

Crisscross the chains under the trailer tongue to prevent the tongue from dropping to the road if the trailer separates from the hitch ball. Rig the chains as tight as possible with just enough slack to permit tight turns.

Make sure the proper chains are correctly attached between the towing vehicle and trailer before and during each trip.

Figure 3-2. Safety Chains

Tie-Downs

Making sure your boat is held securely in place on the trailer hull supports is extremely important, especially when underway. Regardless of your trailer make or model, there are two key areas to consider:

- **Bow Tie-Downs:** A bow stop to hold the front of your boat in place is located on the winch stand. It should be positioned so that the winch line pulls straight and is parallel to the trailer frame. A separate tie-down should then be attached to hold the boat downward and forward. This may be accomplished by a line from the bow eye to an attachment point on the trailer frame or winch stand.

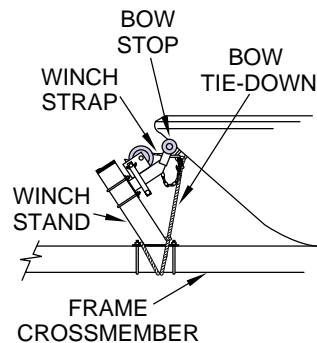

KC-1711.3M

Figure 3-3. Bow Tie-Down

- **Rear Tie-Downs:** It is very important to be sure the transom of your boat is resting fully and securely on the supports provided at the rear of the trailer, and that it remains in place when parked or underway. Special rear tie-downs are available for this purpose. Check often to be sure the rear tie-downs are securely locked in place and tight enough to prevent any movement of the boat.



Figure 3-4. Transom Tie-Down

Backing the Trailer

Backing the boat trailer may sometimes be a difficult task. It is recommended that you practice backing the trailer in a vacant lot or open area before attempting it at a congested boat launch.

Follow these basic rules when backing:

- 1) Turn the front vehicle wheels in the opposite direction in which the trailer is to travel.
- 2) Back vehicle normally once the trailer turn is started.
- 3) Have your vehicle equipped with a right hand mirror, as required by law when towing.

Launching

Following are some helpful tips to assist you with launching your boat:

- Before launching, check the type and condition of the ramp. Ramps are usually made of cement but often times are made of asphalt or even sand. When wet, these ramps can get very slick and can cause additional difficulties when launching your boat.
- Have someone assist you when backing your boat. Back the trailer to the edge of the water and stop. Be sure to properly secure your vehicle.
- Prepare for placing the boat in the water by removing any tie-down straps, disconnecting tail light connections, and attaching a line to the bow eye fitting. If you are using an outboard, be sure that the outboard unit is trimmed up. Be sure to re-install the bilge drain plug if it has been removed.
- To launch, back the trailer into the water to a point where the boat will clear the bottom. Stop and secure the vehicle.
- Unlock the winch line from the boat. Push the boat into the water and have your assistant guide the boat with the bow line.
- Once the boat is cleared of the trailer, pull your vehicle out of the water and park it.

Reloading Procedures

To reload, repeat the unloading procedures in reverse. Other important tips to remember are:

- Try to idle coast onto the trailer; do not power onto the trailer.
- When pulling the boat onto the trailer, be sure the boat is centered as much as possible. The distance between the boat and runner board should be approximately equal on both sides.
- Make sure the boat is securely in place before moving the trailer.

Fueling

It is very important to take special precautions to avoid spillage while fueling your boat. Gasoline vapors are heavier than air and will develop in the lower cavities of the boat, such as the bilge.

Below is a list of guidelines you should follow when fueling your boat:

- 1) Extinguish all cigarettes and other flame or spark producing items.
- 2) Make sure all power is off, and do not operate any electrical switches.
- 3) Be sure to wipe off any spillage that may have occurred.
- 4) Operate the bilge blower for a minimum of four minutes before starting the engine.

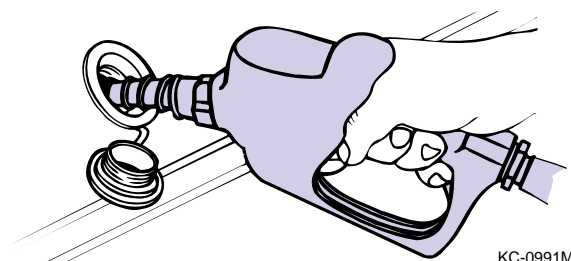

Figure 3-5. Fueling

Warning



Do not allow the fuel tank to empty completely during operation. Doing so may damage the fuel pump. Damage from running fuel systems empty is not be covered under standard warranty.

Caution

Do not overfill fuel tank. The fuel tank will expand and contract based on weather conditions, and can cause fuel to spill out the fuel exhaust vent. Damaged caused to your boat from leaking fuel due to overfilling is not covered by your warranty.

Starting

Starting procedures will vary depending on the type and model of engine installed in your Malibu. Consult the engine owner's manual for more specific information regarding starting, operation, and troubleshooting for your particular engine.

Pay close attention to the information regarding the break-in period listed in your engine owner's manual. Top engine performance is dependent upon following the guidelines listed.

Pre-Start Checklist

A routine pre-starting procedure should always be carried out before the first start-up of the day. Below is a list of basic, necessary checks to perform before starting your engine.

- 1) Replace drain plugs.
- 2) Check oil and transmission fluid levels.
- 3) Check fuel supply.
- 4) Inspect the engine compartment for water or fuel leaks.
- 5) Operate bilge pump until bilge is dry.
- 6) Operate blower for a minimum of four minutes to expel fumes.

Starting the Engine

Malibu boats are equipped with sensors that constantly monitor various functions of the boat. Certain functions, if outside of pre-determined operating parameters, may activate an alarm located under the dash. When the ignition key is turned ON, the alarm will sound to indicate it is operating. Once the engine is running, the alarm should be off unless a problem is detected. If the alarm sounds during operation, stop the boat as soon as possible and turn off the engine. Investigate and correct the problem before returning to operation. Pressing the up arrow of the DISPLAY rocker switch will temporarily silence the alarm. Following is a list of monitored functions that can activate the alarm:

Engine Oil:

RPM's above 300 and below 1000 with oil pressure below 4 psi.
RPM's above 1000 with oil pressure below 18 psi.

Engine Temperature:

RPM's above 300 with temperature above 203°. Alarm will reset when engine cools below 198°.

Battery Voltage:

Voltage drops below 11 volts.
Voltage is above 16 volts.

Fuel Level:

Fuel level drops below 1/8 of the total fuel tank level.

Water Depth:

Water is shallower than water depth alarm setting.

Refer to Section 4, Maintenance, Electrical, for more information on the alarm. Please refer to your engine owner's manual for the proper starting procedures.

Shifting/Running

The throttle lever is located to the right of the driver. When the throttle is vertical, it is in the “NEUTRAL” position.

Located at the base of the throttle you will find the shift lock. Pulling outward on this button disengages the transmission, thereby allowing for use of the throttle without engaging the transmission. This is needed for starting or warm-up of the engine. Be sure to position the throttle vertically (in neutral) before re-engaging the transmission by depressing the button.

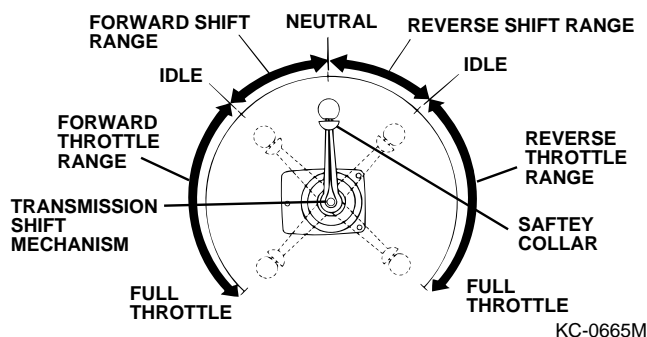

Figure 3-6. Throttle Positions

When engaging the transmission from neutral to either forward or reverse, you must pull up on the safety collar located directly below the throttle lever knob.

Notice: For more information regarding the safe operation and maintenance of the throttle control, refer to the separate instructions located in the information packet shipped with your boat.

Steering

It is important that you get the “feel” of your boat’s steering system. Turn the wheel from full left to full right, and make sure the rudder is turning accordingly. The system should operate freely and smoothly.

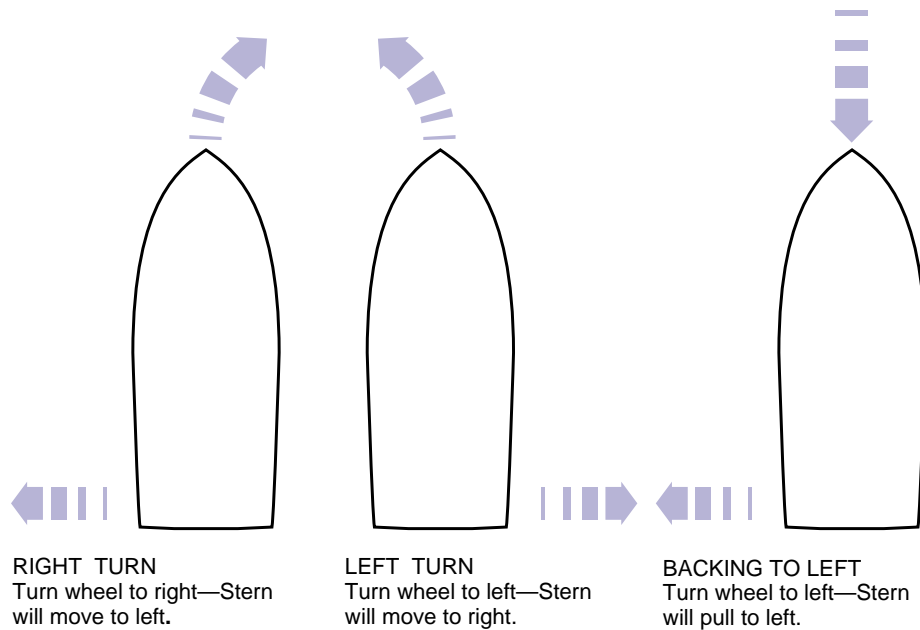

KC-1071R

Figure 3-7. Turning With A Rudder

Warning



The steering system must be in good operating condition for safe boat operation. Frequent inspection, lubrication, and adjustment by your dealer is recommended.

All boats have a tendency to wander somewhat at slow speeds. A natural reaction to this effect is to steer the boat back and forth in an attempt to compensate for wandering. Invariably, the compensation will result in oversteer and only worsen the effect. Keep the steering wheel in the center position, the boat will wander back and forth somewhat, but the overall course will be a straight one.

Maneuvering Techniques

Steering response depends on three factors: engine position, motion and throttle.

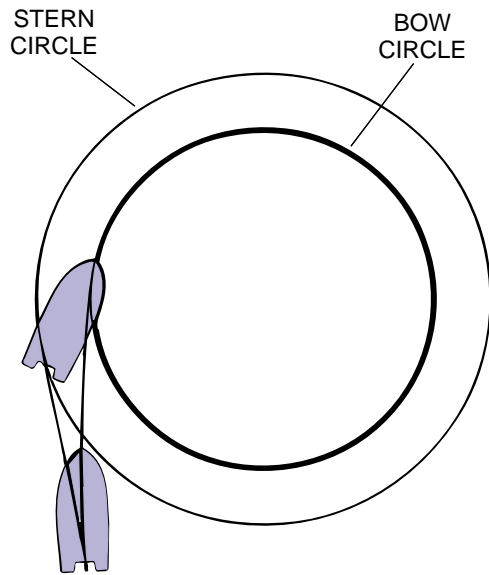

KC-1470

Figure 3-8. Stern Push

aspect shared by all single engine propeller-driven watercraft. A clockwise rotation propeller tends to cause the boat, steering in the straight ahead position, to drift to starboard when going forward, and to port when going backward. At high speed, this effect is usually unnoticed, but at slow speed; especially during backing, it can be powerful. For this reason, many veteran boaters approach the dock with the port side of the boat toward the dock, if possible.

Like an automobile, high speed maneuvering is relatively easy and takes little practice to learn. Slow speed maneuvering, on the other hand, is far more difficult and requires time and practice to master.

When making tight maneuvers, it is important to understand the effects of turning. Since both thrust and steering are at the stern of the boat, the stern will push away from the direction of the turn. The bow follows a smaller turning circle than the stern.

The effects of unequal propeller thrust, wind, and current must also be kept in mind. While wind and current may not always be present, an experienced boater will use them to his advantage. Unequal thrust is an

Stopping

When stopping the boat, it is important to remember there are no brakes to allow coming to a complete, immediate stop. To stop your boat, anticipate ahead of time and begin slowing down by pulling back on the throttle.

Once the throttle is in neutral and the engine has stopped pulling the boat forward, it may be necessary to pull the throttle into reverse to further slow the forward momentum of the boat. The reverse thrust of the engine will decrease the forward speed and slow the boat down to a safer maneuvering speed.

Warning



Do not use the engine stop switch for normal shut down. Doing so may impair your ability to re-start the engine quickly or may create a hazardous swamping condition.

Docking

Docking procedures for the new boat owner usually bring surprising results. Remember, operate your boat at slow speeds to avoid accidents and practice docking to gain experience and confidence.

Once away from the dock, practice docking in open water with an imaginary dock. Pull up to the dock at a slow rate of speed. Shift the boat into neutral and drift slowly toward the dock. Shift the boat into reverse slightly to slow or stop the boat altogether.

Warning



Never use your hand, arm or other part of your body to attempt to keep the boat from hitting the dock. The boat could push against the dock, causing severe injury.

Follow these guidelines when docking:

- Approach docks with the starboard side of the boat if possible.
- Come to a stop a short distance from the dock, then proceed slowly.
- Have fenders, mooring lines and crew ready.
- Observe how the wind and current are moving your boat. Approach the dock with the boat pointed into the wind, if possible. If the wind or current is pushing you away from the dock, use a sharper angle of approach. If you must approach the dock downwind or down current, use a slow speed and shallow angle. Be ready to reverse to stop and maintain position.
- If there is no wind or current, approach the dock at a 10 to 20 degree angle.
- If possible, throw a line to a person on the dock and have that person secure a bow line.
- With the bow secure, swing the stern in with the engine, or pull it in with a boat hook.

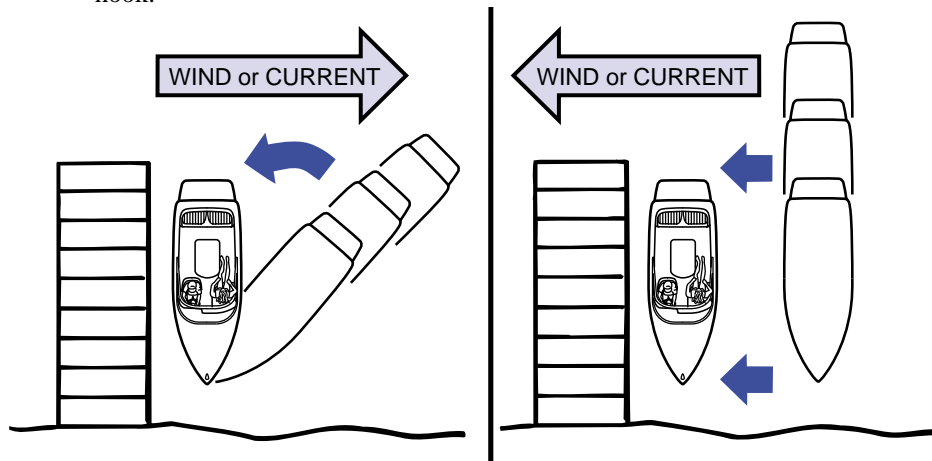

KCB-008

Figure 3-9. Docking With Wind/Current

Before tying up the boat, be sure to use enough fenders to protect the boat from damage. If possible, tie up with the bow toward the waves with a good quality double-braided nylon line. Tie up only to the lifting or tie-down eyes; never use the handrails or windshield frames. If the boat is to be moored for a long period of time, use chafing protectors on lines to protect the gelcoat finish. Leave a little slack in the lines to allow for some wave movement or tidal action if applicable.

Follow these guidelines when departing:

- Very slowly shift into forward at idle speed.
- When the stern moves away from the dock, turn the engine away from the dock.
- Cast off bow line and back away.

If the wind or current is pushing away from the dock, cast off all lines and allow to drift until you are clear.

High Speed Operation

A great deal of caution must be exercised when operating any boat at high speeds. This is particularly true during turns. Gradual turns can be completed at high speed by a competent driver, but it must be emphasized that sudden turns at any speed, particularly at high speed can be especially dangerous. It is possible to throw passengers from their seats and even from the boat if caution is not exercised.

Towing A Skier

Water skiing is a collective effort involving driver, observer and skier. The degree of understanding and cooperation between them directly determines the success and enjoyment of the venture. All must understand that the skier is an extension of the boat. The driver is no longer responsible for a boat that is 20 feet long, but closer to 95 feet. Once this is understood, you are underway to a safe and secure adventure together. A healthy respect for Common Sense Rules of waterskiing safety on the part of the skier, driver and observer will ensure the risk of skiing accidents is kept to a minimum at all levels of participation.

A moderate ability to swim is advisable for waterskiers, but swimming ability is no substitute for a well-fitting life jacket. The wearing of a life jacket or personal flotation device (PFD) is essential even for expert swimmers. The jacket should be Type III, approved by the U.S. Coast Guard and designated as a ski jacket. The jacket should fit snugly, otherwise it could slip up over the skier if the skier should happen to fall at high speed.

Communication between the skier and driver is essential. Standard signals have been developed by the American Waterski Association and have been accepted by most waterskiers. Once the skier is in the water and ready, the driver of the boat will take the slack out of the tow line. When the skier is in position and prepared for lift, the skier shouts "hit it" which is the signal for the driver to open the throttle for take-off. Once the skier is on plane, there are a number of hand signals that will allow communication between the skier and the driver of the boat. A copy of these signals can be found for review at your local Malibu dealership or by contacting the American Waterski Association at (813) 324-4341.

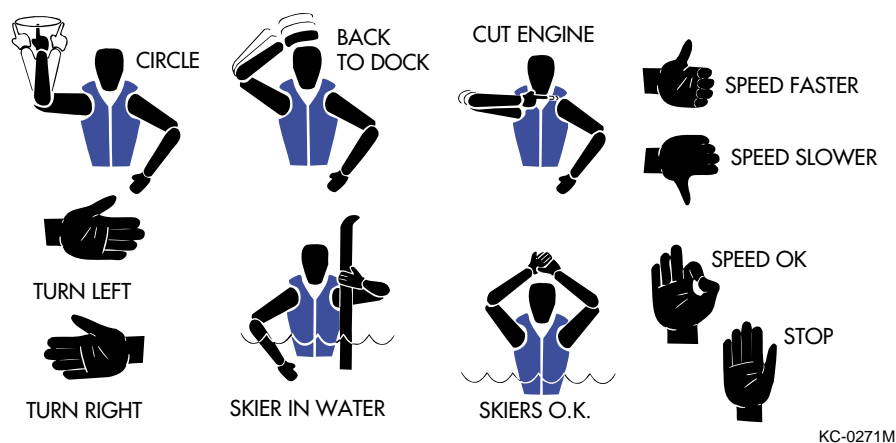
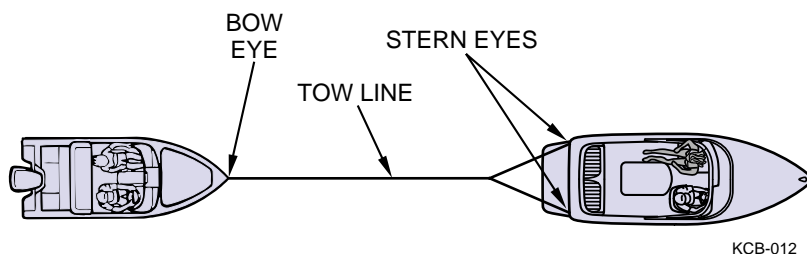

Figure 3-10. Hand Signals

Once a skier has fallen or is ready to quit skiing, the driver must be prepared for immediate removal of the skier from the water. The driver of the boat should keep the skier in line of sight as much as possible until the skier is reached. Once the boat is up to the skier, the driver should always turn off the engine until the skier is onboard. There should be no exception to this rule as there is always the possibility of the skier slipping or falling back into the water risking contact with the boat propeller.

Towing Another Boat

Towing is normally a last resort because damage can be created by stress from the towing lines or uncontrollability of the boat being towed. Only when ideal conditions arise — lake is calm, the disabled boat is smaller than yours, and both boat operators know correct technique — should a recreational boat be towed by another.



KCB-012

Figure 3-11. Towing

Because the towing boat is the maneuverable boat and the grounded boat is not, you should pass the tow line to the grounded boat. Use double-braided line. Never use three strand twisted nylon; it has too much elasticity and can snap back dangerously. Fasten the towline as far forward as possible on the upwind or up current side of the boat being towed. Fastening it to the stern will restrict maneuverability. Attach the line to the stern lifting eyes of the towing boat. Keep lines free of propellers on both boats. Keep hands and feet clear of other boat and never hold towline after it is pulled taut.

Move slowly to prevent sudden strain on slack line.

Be ready to cast loose or cut the line if conditions become hazardous.

Anchoring

There are many types of anchors available on the market. The choice on which one to choose depends on the usage. Contact your dealer on what anchor would suite your situation.

Warning | *Always anchor from the bow of the boat. The boat has less chance of breaking free if a heavy wind comes.*



Propellers

Nothing is more important to the proper performance of your boat than the condition of the propeller. Even slight propeller damage can mean the loss of one MPH. Greater damage can mean considerably more speed loss. Worse yet, damage usually is not done to each blade uniformly and, therefore, sets up imbalanced vibrations that can cause fatigue damage to other parts of the engine or drive system.

Your propeller is custom calibrated for your Malibu by our Research and Design team to give maximum performance. Before installing props other than those suggested by Malibu contact your dealer, otherwise adverse handling and top speed characteristics may be experienced.

The prop is identified by two numbers, i.e., 13 x 14, and material identification such as brass or stainless steel. The first number is the diameter of the prop and the second is the pitch. The pitch is the angle of the blades and is measured in how far the boat will travel through the water in one revolution. In this case, for every one revolution the boat will travel 14 inches.

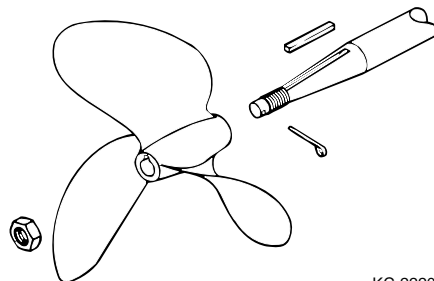

KC-2220M

Figure 3-12. Propeller

Warning



Do not operate engine above the manufacturer's recommended RPM rating; severe damage could result, voiding the warranty.

At least once a year, more often if you use your boat extensively, you should have your local Malibu dealer inspect the propeller for any possible damage.

At least once a month, if you use your boat regularly, you should check and tighten the prop nut. If it is necessary to remove the prop, use care. If the prop is not removed correctly, damage could result if it comes off the shaft too quickly and hits the ground. Whenever possible, use a prop pulling tool to remove prop, this will reduce the chance of damaging the prop.

Corrosion Protection

Galvanic corrosion (electrolysis), is the break-up of metals due to the effects of electrolytic action. When two dissimilar metals are immersed in a conductive fluid such as salt water, an electric current is produced, similar to that of a battery. As the current flows, it takes with it tiny bits of the softer metal. If not stopped, a great deal of damage can occur.

If you operate your boat in salt or brackish waters, you should have your boat equipped with a transom mounted zinc anode to prevent damage to the parts coming in contact with the water. The zinc anode being the softer metal will deteriorate and erode much faster than the other metals in the boat. Inspect the anode periodically and replace as needed. Consult your local Malibu dealer for this part.

Salt Water Corrosion

The entire boat should be rinsed with fresh water immediately after use in salt water. If the boat is used primarily in salt water, wash the hull monthly and apply corrosion inhibitor to all hardware. See your dealer for products suitable for the marine salt-water environment. Fresh water internal flushing is recommended when used in salt, polluted or brackish waters. Flush the entire cooling system with fresh water for at least five minutes after use in these waters. See your Malibu dealer for appropriate flushing devices.



Chapter 4

CARE AND MAINTENANCE



The following guidelines discussed in this section will protect the investment you have made by preserving the beauty and performance of your new boat for years to come.

Interior

Carpet

Your Malibu boat is equipped with a top quality, all-weather indoor/outdoor carpet. It is essentially waterproof and fade resistant. Occasional vacuuming and scrubbing with soap and water will remove embedded dirt and grit.

Vinyl

All upholstery items aboard your boat are made of a tough marine vinyl that is easily cleaned with a mild detergent and warm water. After washing the vinyl, be sure to dry it thoroughly.

Our materials are mildew resistant, but there are no products available to us that are mildew proof. Therefore, we also recommend that you dry the upholstery thoroughly at the end of each day's boating activity to prevent mildew which will rot the upholstery threads and backing. We also recommend that you tip up all seat base cushions on edge after each use to allow any accumulated water to drain.

Exterior

Your Malibu boat is highly resistant to weathering, water pollution, and minor scrapes which occur during normal use. However, regular care and maintenance of your boat is a general responsibility for all Malibu boat owners. By following the boat care instructions listed below, you will be able to extend the life and beauty of your Malibu boat.

Fiberglass and Gelcoat

The fiberglass hull and deck of your Malibu boat consist of a molded shell and exterior gelcoat. The gelcoat protects the fiberglass shell and gives all Malibu boats a smooth and shiny surface. The following are some general instructions which will help you maintain your boat's sleek appearance:

- 1) Wash monthly or more frequently, depending on use. Use a mild dish washing soap and lukewarm or cold water. Rinse your boat with fresh water and wipe down immediately to avoid water spots.

- 2) Wax the boat hull and deck after every three or four outings to decrease water friction and to lessen the potential for staining or spotting the gelcoat surface. In cases where the original gelcoat shine cannot be restored by waxing, hand buff the surface using any commercial compound. Be sure to apply several coats of wax over the area that has been polished.

Surface Stains

Stains can appear as a result of dust, road tar, plant sap, rust from metal fittings, and other materials coming in contact with your boat's exterior. Listed below is a step-by-step procedure to remove stains from your boat:

- 1) Wash area with dish washing soap
- 2) Apply a mild cleanser on a small area (3 x 3 feet)
- 3) Rinse with fresh water
- 4) Buff with a fine rubbing compound
- 5) Wax

If the stain is not removed by the dish washing soap or mild cleanser, then the next procedure is to use either denatured or rubbing alcohol. Common rubbing alcohol is excellent for removing stains.

Scratches

Scratches to the gelcoat sometimes occur during normal use. Your dealer can usually restore the gelcoat to like-new condition.

Underwater Corrosion

Corrosion occurs in saltwater conditions from the interaction of the saltwater and the direct current of the battery. To prevent corrosion, it is important to keep the bilge area as dry and clean as possible.

Care For Boats That Are Moored

Due to gelcoat discoloration, osmosis (blistering), and algae growth, it is not recommended that you leave your boat moored for long periods of time. If your boat will be moored in fresh water or saltwater for extended periods of time, you should do the following:

- 1) Haul-out and clean your boat regularly (every 14 to 21 days). Use soap, water, and plenty of elbow grease.
- 2) Apply wax after cleaning.

You should also check with your local Malibu dealer about anti-fouling paint and other products that can be applied to the hull bottom below the water line.

Teak Wood

Care must be taken to keep teak wood from turning gray or rough. The roughing becomes more apparent as the moisture evaporates and dries out.

It is suggested that you use teak or mineral oil treatments at least four times a year to maintain the appearance of your swim platform. Use a high quality teak oil which can be purchased at your local Malibu dealership.

For additional information on care, maintenance, and warranty on your swim platform, please see the information provided in your Owners Packet.

Notice: Teak wood should never be varnished.



Engine/Drive Train

Engine

For information on engine service, maintenance, and break-in period, please refer to your engine owner's manual. The Required Maintenance Schedule included in this manual covers the minimum maintenance required for Indmar engine packages. The Maintenance Worksheet included in this manual outlines safety checks, lubrication, and general service that should be performed at regular intervals. It is recommended that any engine replacement parts used for maintenance or repair be supplied by an authorized Malibu dealer.

Engine Specifications 2003

	Malibu Carbureted Vortec 310 HP	Malibu Monsoon 325 HP	Malibu Hammerhead 365 HP	LS1 Corvette 375 HP	8.1 MPI Vortec
Number of Cylinders	V-8				
Displacement	5.7L 350 CID				496 CID (8.1L)
Bore/Stroke	4.0012x3.480 in (101.63 x 88.39 mm)			3.898 x 3.622 in (99 x 92 mm)	4.25 x 4.37 in. (108 x 111 mm)
Compression Ratio	9.4:1			10.1:1	9.1:1
Compression Pressure (1)	Minimum 100 PSI (690 kPa)				
Idle RPM in Neutral (2)	650 ± 50 RPM				
Operating Range at Wide Open Throttle	4400-4800 RPM	4600-5200 RPM		5200-5600 RPM	5000-5400 RPM
Oil Pressure at Idle	4PSI (41kPa) Minimum - Hot				5PSI (34kPa) Minimum
Oil Pressure at 2000 RPM	18 PSI (124 kPa) Minimum Hot				10 PSI (69 kPa) Minimum
Oil Filter	Pennzoil PZ3, AC-PF25			NAPA Gold 1042	AC-PF454
Fuel Pump Pressure	8 PSI Max (55.2 kPa)	40 PSI Min at Keyup (275.8 kPa)		50 PSI Min at Keyup (344.7 kPa)	
Electrical System	12 Volt DC Negative (-) Ground				
Minimum Battery Requirements	550 cca/700 mca/120Ah				
Firing Order	1-8-4-3-6-5-7-2			1-8-7-2-6-5-4-3	
Spark Plug Type	MR43LTS			AC 41-931	Nippon Denso TJ14R-P15
Spark Plug Gap	.030 in (.76 mm)	.045 in (1.1 mm)		.050 in (1.3 mm)	
Base Timing at 1000 RPM (3)	10 Degrees Before Top Dead Center			Non Adjustable	
Thermostat	160 Degrees F (71 C)				

Fluid Capacities

Crankcase (With Filter) (4)	5.5 Quarts (5.25 L) With Filter		8 Qts.(7.6 L)
Closed Cooling System (5)	12-14 Quarts (11.4-13.3 L)		14-16 Qts (13.2-15.1 L).
In-Line Transmission (4)	2.12 Quarts (2.0 L)		
Walters V-Drive Transmission (4)	2 Pints (.95 L)		Not Used
Hurth V-Drive Transmission (4)	Not Used		4.4 Qts (4.16L)

Notes

- 1) Minimum recorded compression in any one cylinder should not be less than 70% of the highest recorded cylinder.
- 2) Measured using an accurate shop tachometer at normal operating temperature. Idle RPM on EFI models is not adjustable.
- 3) Timing must be set using special procedures indicated in the appropriate service manual. Timing cannot be set using conventional methods. Special tool(s) required.
- 4) Always use dipstick to determine exact quantity of oil required. Do not fill above "FULL" mark.
- 5) Do not over fill. Correct level is 3/4" below filler neck when coolant is warm.

Transmission

Check fluid only with engine OFF and boat floating level, or level on trailer. The transmission dipstick is located on the top of the transmission. Dipsticks may be marked “ADD” and “FULL” or “H” and “L” (high and low); maintain fluid level between the two marks.

Caution | *Check level immediately after turning engine off. Transmission fluid may be hot. Be careful not to burn yourself.*

TRANSMISSION	MODEL	CAPACITY	FLUID TYPE
ZF Hurth In-Line	450D	1.7 qt (1.6L)	Pennzoil Dexron II, III or MERCON
ZF Hurth In-Line	450A	2.12 qt (2L)	Pennzoil Dexron II, III or MERCON
ZF Hurth In-Line	630A	4.2 qt (4L)	Pennzoil Dexron II, III or MERCON
ZF Hurth V-Drive	630V	4.2 qt (4L)	Pennzoil Dexron II, III or MERCON
Walters V-Drive	RV-26D-71V	0.5 qt (0.5L)	Pennzoil SAE 30 Motor Oil

Caution | *Do not overfill the transmission. Overfilling can damage the transmission. Damage to your transmission due to too much or too little fluid is not covered by your warranty.*

Operate boat approximately five minutes to warm the transmission fluid. Turn engine off and disconnect the engine safety switch. Ensure throttle is neutral.

Note: Check immediately after shutdown to prevent incorrect reading.

- Open engine compartment and locate transmission fluid level dipstick.
- Remove dipstick and wipe with a clean rag. Quickly re-insert the dipstick fully and immediately remove. Check the fluid level is at the full warm mark on the stick.

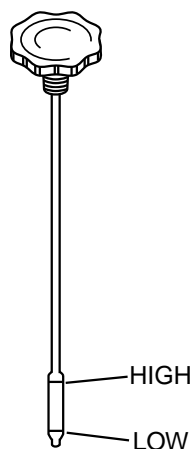

KC-2175

Figure 4-1. Typical Transmission Dipstick

- Add or remove fluid as necessary to maintain the level at the mark. Use only recommended automotive transmission fluid. You will find recommended fluid types in your Indmar Owner's Manual.

Rudder Stuffing Box

The rudder stuffing box has a grease nipple and should be checked and lubricated annually. The rudder stuffing box is accessed through the rear center access panel directly below the fuel tank. Use only a marine grade, waterproof grease.

Shaft Packing

Located in the bilge, under the rear center access panel, is the shaft packing. The shaft packing is a seal where the prop shaft goes through the hull of the boat. This seal should be checked and tightened periodically. Please note that it is normal for a small amount of leakage to occur from this seal. It should leak at the rate of about one drop every ten seconds.

Fuel System

Fuel Filter

An in-line fuel filter is located 6 to 12 inches from the fuel tank. The filter removes debris from the fuel being sent to the engine. The filter should be changed after each season of boat use. Often, fuel from local Marinas will have a considerable amount of debris and can eventually cause your engine to run erratically. See your local Malibu Dealer for servicing.

Hoses

Fuel lines, vent hoses, and drain hoses should be checked frequently for leaks. If this is occurring around the fitting, tightening of the hose clamps may be all that is necessary. However, if the leak continues, replace the hose immediately to prevent a build-up of fluids or gases. Surface cracking on hoses indicates wear, and replacement is recommended. Use fuel system parts certified for marine use only. Do not substitute with automotive parts.

Electrical

Engine Circuit Breaker

Your engine is equipped with a 50 Amp Circuit Breaker to protect the engine electrical system and components from overload, and is found on the lower right side of the engine. If your engine should lose power and will not crank, reset the breaker by firmly pressing the red button (an audible sound will be heard). For additional engine electrical issues, see your Indmar Engine Owners Manual, or contact your Local Malibu dealership.

Main Circuit Breaker

Located adjacent to the battery is a 60 AMP Circuit Breaker. If your boat's systems lose electrical power, and you have no dash gauges or your engine does not turn over, you will need to reset the breaker to restore power to your boat's systems. To reset, find breaker switch and depress until lever locks into position.



Figure 4-2. Main Circuit Breaker

Warning



Power loss to the Main Breaker is an indication of serious issues to your boat's electrical and/or engine components. Contact your local dealer for evaluation of these components.

Boat Alarms

Malibu boats are equipped with sensors that constantly monitor various functions of the boat. Certain functions, if outside of pre-determined operating parameters, may activate an alarm located under the dash. Both the engine Electronic Control Module (ECM) and the dash gauge computer may activate the alarm.

If the ECM activates the alarm, it will store a trouble code in memory. Stop the boat as soon as possible and turn off the engine. You will need to have your Malibu dealer run a diagnostics test to repair the engine and clear any codes from memory. The ECM uses the engine oil pressure, engine temperature and transmission temperature switches for input and parameters are stored in the ECM.

If the dash gauge computer activates the alarm, the Multi Function Display Panel will indicate the source of the problem. If the alarm sounds during operation, stop the boat as soon as possible and turn off the engine. You will need to have your Malibu dealer run a diagnostics test to repair the engine and clear any codes from memory. The dash gauge computer uses a separate set of sending units on the engine, fuel tank and depth transducer for input and parameters are stored in the computer.

Refer to Section 3, Operation, Starting, for more information on the alarm.



Battery

Your Malibu boat is equipped with a standard 12-volt battery. The battery comes with a non-metallic box to help contain spills and prevent corrosion.

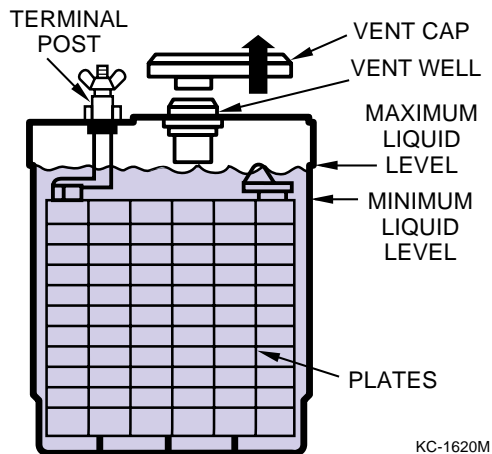

Figure 4-3. Battery Level

Check your battery terminals frequently for corrosion and tightness. Clean terminals with a baking soda and water solution and a wire brush. Also, check the fluid levels in the cells. Usually, a level approximately 1/4 to 1/2 inch above the plates is sufficient. If needed, fill with distilled water. Some batteries are sealed and this process is not necessary. Read directions when applicable.

Battery Isolator Switch

This option provides the ability to isolate the boat batteries if more than one battery is used. If so equipped, the isolator switch is located behind the front observer's seat under the dash next to the battery. Under normal situations, the switch should be in "POSITION 1" or "POSITION 2" rather than in the "ALL" position. This will keep one battery charged should one of the batteries fail.

Circuit Breakers and Fuses

Most electrical standard equipment devices are controlled with circuit breakers. These breakers will activate if overloaded and cut power to the switch. To restore power, simply push the breaker button in and release. Breakers do not require fuse replacement. The breaker panel can be found under the dash next to the 12-volt adapter. The stereo, if so equipped, has an inline fuse. If your stereo should quit working, check fuse as well as the breaker.

12-Volt DC Accessory Outlets

All models except Sportster and Flightcraft are equipped with two 12-volt DC Accessory Outlets; one on the electrical panel below the dash, and one in the glove box. These outlets provide power from your boat battery to accessory equipment such as cellular phones, video cameras, marine spot lights, etc. Sportster and Flightcraft models do not have the extra glove box outlet.

Miscellaneous

Hardware

Most of the metal hardware on your boat consists of brass, stainless steel, or aluminum and should be cleaned on a periodic basis with soap and water. In fresh water, metal fittings and hardware should be sprayed annually with a rust inhibitor such as WD-40, and every two or three months in saltwater.

Bilge

The bilge of your boat can accumulate oil and greasy dirt over a period of time and should be cleaned out periodically. Usually, ordinary soap and water does not remove the accumulation and something stronger will be needed. Check with your Malibu dealer for recommendations.

Windows and Windshields

The windows and windshields on your Malibu boat are made of tempered safety glass and are similar to the windows in your car. The glass will scratch however, and abrasive cleaners should not be used to clean your windows. Soap and water or automotive glass cleaners may be used.

Winterizing

When the boating and ski season comes to an end, it is recommended that the boat be removed from the water and stored. It is extremely important that proper winterizing procedures are read and followed to ensure longer boat life. Here is our list of suggestions to keep your boat in top condition:

- Prepare the engine according to the instructions found in your engine owner's manual. It our recommendation that you contact your local Malibu dealer for full winterization procedures.
- Clean and dry the boat interior and exterior thoroughly. Inspect boat hull for residue and remove any if present.
- Clean the bilge area thoroughly and operate the bilge pump to remove any water from bilge lines.
- Remove all seat cushions and open all storage areas. Store the seat cushions in a cool and dry place.
- Cover the boat and store it in a garage or other protected facility.
- If the boat is stored on a trailer, you should block the trailer wheels.

Storage and Winter Lay-up

Due to the problems that can occur from improper winterization, we recommend that you take your boat to a certified Malibu dealership to perform this task. Without proper preparation, storage for long periods of time may cause parts of the engine and transmission to rust due to lack of lubrication. Also, if your boat will be stored in freezing conditions, water inside these components to include cooling system, heater and shower could result in major damage to your boat. Damage done due to improper winter storage will void your warranty. Here is our list of suggestions to keep your boat in top condition.

Prior to boat being removed from water:

- Fill fuel and add 1 ounce of **STA-BIL**® fuel stabilizer for each 5 quarts of gasoline.
- Operate boat for at least 15 minutes in water or using a flush system to allow treated fuel to flush engine.
- Add lightweight engine oil (SAE-10 or fogging oil) slowly to the engine while engine is slightly above idle. Turn engine off. Consult your local dealer for correct procedure.

To be completed when boat is put on trailer or resting cradle:

- Remove bilge T-handle and transom drain plug immediately after removing from the water.
- Clean and dry the boat interior and exterior thoroughly. Inspect boat hull for residue and remove if present.
- Clean bilge area thoroughly and operate the bilge pump to remove any water from bilge lines.
- Remove all seat cushions and open all storage areas. Store the seat cushions in a cool dry place.
- Apply coat of wax to entire surface of boat.
- Flush engine-cooling system with clean water. Do not exceed 1500 RPM while flushing for 5-10 minutes.
- Turn fuel supply line to the OFF position (handle perpendicular to fuel line). Perform annual scheduled maintenance. Refer to engine owner's manual for complete engine winterization procedures as well as scheduled maintenance.

Note: Damage done due to improper engine winter storage will void your warranty. It is highly suggested that you allow a trained Malibu technician to perform this service.

- After performing engine winterization, remove engine safety switch and spin engine over a few seconds to remove excess water found in pump bodies.
- Remove the negative cable from battery. Charge battery to full charge and remove from boat.
- Clean all traces of dirt, oil and grease from engine, transmission and bilge. Coat all areas on transmission and engine where paint has been removed with touchup paint.
- Use duct tape to seal the exhaust flaps closed to prevent dirt and rodents from entering exhaust.
- Remove propeller assembly, and store in safe place.
- If your boat is equipped with an optional heater or hot-water shower, remove both hoses and blow through hose to remove excess water.
- Cover the boat with cover, tarp or, if available, shrink-wrap tarp. Also, due to the excess weight that can occur from rain and snow for boats that are stored outside, it is suggested that you make a support of two inch PVC piping that can be mounted under the covering material. The rounded PVC piping will ensure the cover does not tear and will eliminate pooling water inside boat.

Winterization Re-Commission

- Remove boat cover or shrink-wrap from boat.
- Remove duct tape from exhaust flaps.
- Charge and install battery in boat. Follow all safety precautions associated with changing batteries.
- De-winterize engine using engine manufacturer's specifications.
- Check propeller shaft alignment. Tighten coupling hardware.
- Check engine compartment for nesting animals. Clean as needed.
- Reinstall seat cushions from storage.
- Check entire engine for signs of cracks caused by freeze damage. Check all hose clamps for tightness. Install bilge drain plugs.
- Reinstall propeller assembly.
- If not performed during winterization, perform annual maintenance at this time.
- If boat is equipped with optional fresh-water cooling, and was drained at winterization, fill at this time.
- Turn fuel shut-off valve to the ON position. (Handle is in line or parallel with the fuel line.) Turn key on and off 2-3 times to allow fuel to return to engine, then start engine. When engine starts watch gauges closely, and watch for abnormal readings.

Troubleshooting

The following charts will assist you in finding and correcting minor mechanical and electrical problems with your boat. Problems are listed in the order of the most likely event to the least likely.

To correct a problem, first determine what the problem is. Start with the first cause and eliminate the possibility of each until the problem is corrected. Because of the specialized skills and tools needed to correct major issues, we have not included that information. If you suspect a problem not listed here, please contact your Malibu dealer.

PROBLEM	POSSIBLE CAUSE	SOLUTION
Engine will not turn over	<ul style="list-style-type: none"> • Throttle control in gear. • Main circuit breaker open. 	<ul style="list-style-type: none"> • Shift into neutral. • Reset circuit breaker.
Engine turns over, but will not start	<ul style="list-style-type: none"> • Safety lanyard not connected. • Stop switch not set. • No fuel to engine. • No fuel in tanks. • Fuel filter clogged. • Contaminated fuel. • Distributor problems. 	<ul style="list-style-type: none"> • Connect safety lanyard. • Reset switch. • Turn fuel valve to ON. • Fill fuel tank. • Replace fuel filter. • Replace fuel and filter. • See your dealer.
Engine is hard to start	<ul style="list-style-type: none"> • Flooded engine. • Plugged flame arrestor. • Fouled spark plugs. • Loose coil or ignition wires. • Battery cables loose or corroded. • Weak battery. • Ignition problems. 	<ul style="list-style-type: none"> • Start engine full throttle and back off. • Clean flame arrestor. • Replace spark plugs. • Tighten coil or ignition wires. • Clean and tighten battery cables. • Charge or replace the battery. • See your dealer.
Engine misses or idles rough	<ul style="list-style-type: none"> • Fouled spark plugs. • Loose or defective high-tension leads. • Plugged PVC valve. • Weak ignition coil. • Vacuum leak. 	<ul style="list-style-type: none"> • Replace spark plugs. • Tight or replace the high-tension leads. • Replace PVC valve. • Replace ignition coil. • See your dealer.
Poor boat performance	<ul style="list-style-type: none"> • Fouled spark plugs. • Contaminated fuel. • Plugged flame arrestor. • Weak ignition coil. • Fuel filter clogged. • Ignition problems. 	<ul style="list-style-type: none"> • Replace spark plugs. • Replace the fuel and filter. • Clean the flame arrestor. • Replace the ignition coil. • Replace the fuel filter. • See your dealer.
Poor gas mileage	<ul style="list-style-type: none"> • Fouled spark plugs. • Plugged flame arrestor. • Inefficient driving habits. • Plugged PCV valve. • Ignition problems. 	<ul style="list-style-type: none"> • Replace spark plugs. • Clean the flame arrestor. • Plan the boat quickly, then slow down to desired speed. • Replace PCV valve. • See your dealer.

PROBLEM	POSSIBLE CAUSE	SOLUTION
Throttle/shifting problems	<ul style="list-style-type: none"> • Corroded cables. • Defective throttle return spring. • Low transmission oil level. • Sticking transmission shift detent ball. • Kink in cables. 	<ul style="list-style-type: none"> • Clean and lubricate cables. • Replace the throttle return spring. • Replenish the transmission fluid. • Clean and lubricate detent ball. • Replace the cable(s). See your dealer.
Steering problems	<ul style="list-style-type: none"> • Corroded cables. • Rudder worn. 	<ul style="list-style-type: none"> • Clean and lubricate the cable. • See your dealer.
Excessive vibration	<ul style="list-style-type: none"> • Fouled propeller. • Damaged propeller. • Misaligned propeller shaft coupling. • Bent propeller shaft. 	<ul style="list-style-type: none"> • Remove objects from the propeller shaft and rudder. • Replace the propeller. • Check the alignment. See your dealer for proper realignment. • See your dealer.
Electrical problems	<ul style="list-style-type: none"> • Open circuit breaker or blown fuse. • Loose wing connections or corrosion. • Defective sending unit. • Shorted wiring harness. • Defective switch or gauge. 	<ul style="list-style-type: none"> • Reset the circuit breaker or replace the fuse. • Clean and tighten wiring connections. • Replace the sending unit. • Repair the wiring harness. • See your dealer.
No speedometer	<ul style="list-style-type: none"> • Disconnected, kinked or plugged tubing. • Plugged pitot pickup. • Defective pitot pickup. • Defective speedometer. 	<ul style="list-style-type: none"> • Repair or replace the tubing. • Remove objects from the pickup. • Replace pitot pickup. • Replace the speedometer.
Incorrect speedometer	<ul style="list-style-type: none"> • Blocked pitot tube. • Water in tubing. • Defective speedometer. 	<ul style="list-style-type: none"> • Remove the blockage. • Disconnect the tubing at the speedometer and blow out the tubing. Tighten nut finger snug, then 1/4 turn more. • Replace the speedometer.

Warranty

2003 Malibu Transferable Lifetime Limited Warranty

Malibu Boats West, Inc. warrants to the Original Retail Purchaser that the hull, deck, liner, upholstery frames, and stringers on every new boat manufactured shall, under normal authorized use, be free from structural defects for as long as the original purchaser owns the boat. Malibu Boats West, Inc. or its selling dealer will, without charge, repair or replace at Malibu's option, any boat or portion thereof proven to its satisfaction to be in defect during the above warranty period.

Transferable Option: The above Lifetime Limited Warranty Policy may be transferred (for a minimal fee) to subsequent purchasers during a period of five (5) years from the date of delivery to the original retail purchaser.

Exception: The Lifetime warranty does not cover the gelcoat nor any other components fastened or applied to the dash, hull or deck. Gelcoat discoloration, blisters, and cracks are not considered structural defects. Gelcoat along with installed components are warranted separately under the Malibu "Bow to Stern Warranty" listed below.

2003 Malibu Basic Warranty

What is covered and for How Long

Boat coverage

- Malibu Boats West, Inc. warrants all parts of your 2003 Malibu boat supplied by Malibu, for a period of 36 months or 400 hours, whichever comes first.
- This warranty covers any repairs needed to correct defects in materials or workmanship of all parts and components of each new Malibu boat supplied by Malibu except for the exclusions or items listed under the caption "What is not Covered" or as indicated below.
- This warranty is provided to the original and subsequent owner(s) of a Malibu boat originally distributed by Malibu Boats West, Inc. and which is originally sold by a Malibu Boats West, Inc. authorized Malibu dealership.

Powertrain coverage

Indmar Powertrains

- This Malibu Boats West, Inc. administers the engine warranty for a units equipped with an Indmar powertrain.
- This The powertrain coverage for Indmar equipped units is 36 months with no hour limitation.
- This This warranty covers any repair needed to correct defects in materials or workmanship except for the exclusions or items listed under the caption "What is not Covered".
- Please refer to the Indmar Engine Owner's Manual for specific warranty coverage information.



-
- This warranty is provided only to the original owner of a Malibu boat originally distributed by Malibu Boats West, Inc. and which is originally sold by a Malibu Boats West, Inc. authorized Malibu dealership.
 - The above stated warranty is transferable to subsequent owners for a nominal fee. Contact Indmar Products Co. Inc. for details.

Mercuriser Powertrains

Mercuriser administers their warranty independently from Malibu Boats West, Inc. Please refer to the Mercuriser Engine Owner's Manual for warranty coverage information and specific details on how to submit a claim.

Gelcoat Coverage

- Malibu Boats West, Inc. warrants the gelcoat on your 2003 Malibu for a period of 24 months with no hour limitation.
- This warranty covers any repairs needed to correct defects in materials or workmanship in the gelcoat finish of each new Malibu boat supplied by Malibu except for the exclusions or items listed under the caption "What is not Covered" or as indicated below.
- This warranty is provided to the original and subsequent owner(s) of a Malibu boat originally distributed by Malibu Boats West, Inc. and which is originally sold by a Malibu Boats West, Inc. authorized Malibu dealership.

***Exception**

The above gelcoat warranty applies only to boats with standard white or platinum colored hulls. Boats with optional solid gelcoat color schemes are void of this warranty.

Audio System coverage

- Factory installed audio systems are warranted independently by Prospec Electronics
- Prospec Electronics warrants all audio systems installed by Malibu Boats West, Inc. for a period of 12 months from the date of original retail purchase.
- This warranty covers any repairs needed to correct defects in materials or workmanship except for the exclusions or items listed under the caption "What is not Covered" or as indicated below.
- This warranty is provided to the original and subsequent owner(s) of a Malibu boat originally distributed by Malibu Boats West, Inc. and which is originally sold by a Malibu Boats West, Inc. authorized Malibu dealership.

The Warranty Period Begins

The warranty period begins on the date the boat is delivered to the first retail buyer or put into use, whichever is earlier.

No Charge

- Warranty repairs will be made at no charge for parts and/or labor. Malibu Boats West, Inc., or its selling dealer, will repair or replace, at Malibu's option, any boat or portion thereof proven to its satisfaction to be defective during the above warranty period.
 - Any needed parts replacement will be made using Malibu approved new or remanufactured parts.
-

Obtaining Warranty Service

The boat must be taken to an authorized Malibu Dealer during regular business hours at your expense in order to obtain warranty service. If you need help locating your nearest dealer, contact Malibu Boats West, Inc. for assistance.

Maintenance and Records

As a condition of this warranty, you are responsible for properly using, maintaining and caring for your boat as outlined in your OWNER'S MANUAL, and maintaining copies of all maintenance records & receipts for review by Malibu Boats West, Inc. Failure to do so may result in denial of warranty coverage.

Evidence of the performance of the required maintenance should be kept and presented as proof of such maintenance in connection with related warranty repairs. To assist you in maintaining appropriate records, the Maintenance Log located in the back of this booklet can be used along with the supporting repair invoices, receipts and other such records.

What is not Covered**Damage, Failures or Corrosion Due to Accidents, Misuse or Alterations**

This warranty does not cover damage, failures or corrosion resulting from:

- Accident, theft, fire, or misuse (Proper use is outlined in your OWNER'S MANUAL).
- Alteration, tampering or improper repair.
- Installation of non-Malibu approved accessories or components.
- Improper installation of any Malibu approved or aftermarket accessory or component.
- Glass breakage, unless resulting from defects in material or workmanship.
- Boats that have been altered, overpowered or overloaded.
- Mildew damage, paints, plated finishes, gelcoat finish distortions or discoloration.
- Boats used for racing or any type of commercial use or service.
- Maintenance service expenses as specified in your OWNER'S MANUAL such as engine tune-ups, inspections, replacement of filters, sea water impellers, propshaft packing, lubricants and, and coolant.
- Damage, failures or corrosion from environmental conditions to include but not limited to: salt, tree sap, chemical fallout (acid rain), windstorm.
- Any and all consequential damages including but not limited to costs or charges derived from haul-out, launching, towing, storage charges, telephone or rental charges of any type, inconvenience for loss of use, commercial or monetary loss due to time loss, or any other special or consequential loss of any kind.

Limitation of Warranties

This limited warranty is given in place of and instead of any and all express or implied warranties, and may not be modified in whole or in part by anyone other than Malibu Boats West, Inc.

Some states do not allow a limitation on how long an implied warranty lasts or the exclusion or limitation of incidental or consequential damage; therefore, these limitations may not apply to you. This warranty gives you specific legal rights and you may also have other rights that vary from state to state.

Malibu Boats West, Inc., One Malibu Court, Merced, CA 95340

Phone: (209) 383-7469, Fax: (209) 383-0499

Email: info@malibuboats.com



Glossary

AFT:	To the rear of the boat near the stern. Generally used to give directions.
BEAM:	The widest portion of the hull.
BILGE:	The lowest portion inside the boat. This is generally the section directly below the engine compartment.
BOW:	The forward portion of the boat.
BULKHEAD:	Vertical portion in a boat.
CHINE:	The intersection of the sides and bottom of a “V” bottom boat.
DEADRISE:	The degree of angle from the keel to the chine.
DECK:	Upper structure which covers the hull.
DRAFT:	Vertical distance from the waterline of the boat to the lowest part of the boat.
FibECS II:	An engine mounting method-using fiberglass instead of other materials such as aluminum or steel; patented by Malibu Boats West, Inc. that provides major reduction in noise and vibration.
FIBERGLASS:	Fibers similar to wool or cotton, but made from fibrous glass. Glass fiber forms include cloth, yarn, mat, milled fibers, chopped strands, roving, and woven roving.
GELCOAT:	A surface, either colored or clear, providing a cosmetic enhancement and exposure improvements to a fiberglass laminate.
GUNNEL:	The upper edge of a boat’s side.
HELM:	Device attached to rudder for steering a vessel.
HULL:	The bottom section of the boat.
KEEL:	The lowest most portion of the bottom of the boat.
LIFTING STRAKES:	Strips molded or attached to the surface of a hull designed to create lift as speed and pressure increase with the static water.
PORT:	To the left side of the boat, when facing the bow.
STARBOARD:	To the right side of the boat, when facing the bow.
STERN:	To the rear of the boat.
STRINGER:	Longitudinal members that are fastened inside the hull of the boat which provide structural integrity.
TRANSOM:	The area forming the stern, or rear, of a boat.
WAKE:	The track or path a boat leaves behind while in motion.

Index

- A**
Anchoring 3-13
- B**
Basic Rules Of The Road 1-7
Bow Tonneau Cover 2-9
- C**
Carbon Monoxide 1-6
Circuit Breakers 2-6
Corrosion Protection 3-14
- D**
Docking 3-9
Drain Plugs 2-14
Driver's Seat 2-10
- E**
Electrical 4-6
Emergencies 1-4
Emergency Engine Stop Switch 2-9
Engine / Drive Train 4-3
Exhaust 2-15
Exterior 4-1
- F**
Fueling 3-4
Fuel System 4-5
- G**
General Precautions 1-1
Glossary 4-17
- H**
Hazardous Conditions 1-5
High Speed Operation 3-10
- I**
Integral Self Draining Ice Chest 2-11
Interior 4-1
- M**
Miscellaneous 4-8
Motorbox Cover 2-10
- N**
Navigational Lights 2-13
- O**
Operation by Minors 1-7
Optional Equipment 2-17
- P**
Passenger Safety 1-7
Propellers 3-13
- R**
Regulations 1-2
Responsibilities 1-2
- S**
Safety Statements 1-1
Shifting / Running 3-6
Ski Pylon 2-12
Speedometer Pickup 2-14
Standard Gauges 2-2
Starting 3-4
Steering 3-6
Steering System 2-9
Stopping 3-8
Storage Areas 2-13
Sundeck 2-11
Swim Platform 2-12
Switches & Indicators 2-7
- T**
Throttle Control 2-8
Tilt Steering Wheel 2-15
Towing A Skier 3-11
Towing Another Boat 3-13
Trailing 3-1
Troubleshooting 4-10
- V**
V-Drive Engine Access Hatch 2-11
Ventilation 2-16
- W**
Warning Labels 2-20
Warranty Information 4-14
Wedge 2-19



Maintenance Worksheet

Please circle one- Pre-delivery-/10hr.-/50hr.-/100hr.-/Annual

HULL NUMBER	OWNER NAME	PHONE NO.
-------------	------------	-----------

SERVICE DATE	WORK ORDER #	BOAT COLOR	SERVICE TECHNICIAN
--------------	--------------	------------	--------------------

INSTRUCTIONS

Please complete following; check each item as completed.

- 1. Inspect prop
- 2. Check engine alignment, motor mounts, and jam nuts
- 3. Check shaft packing
- 4. Service rudder (lubrication)
- 5. Check battery, battery hold down, cable connections
- 6. Check instrumentation
- 7. Check lanyard switch operation (kill switch)
- 8. Check lights (bow, stern, and dash)
- 9. Check steering wheel cable fasteners, lubricate support tube and cable
- 10. Check control mechanism MV-2, MV-3 (freedom of movement)
- 11. Check neutral safety switch operation
- 12. Check security of fasteners (seat slides, seats, platform, interior handles)
- 13. Check all fuel connections (engine, tank, pump, filter)
- 14. Check engine exhaust clamps
- 15. Change engine oil and filter
- 16. Change transmission fluid/ filter
- 17. Change V-Drive oil (clean screens / magnetic plugs)
- 18. Change fuel filters (engine / tank)
- 19. Inspect belts
- 20. Inspect impeller
- 21. Clean / change flame arrestor
- 22. Check engine coolant (closed cooling only)
- 23. Check trailer: wheel lugs, lights, and loading bar
- 24. Inspect and lubricate wheel bearings
- 25. Check brake fluid level (if applicable)

LAKE TEST

- 1. Perform TECH I data list scan
- 2. Check PROM ID and record in customer file
- 3. Check engine timing (in service mode)
- 4. Check fuel pressure and log reading
- 5. Verify oil levels (engine, Trans, V-Drive)
- 6. Verify blower operation, check hose attachment
- 7. Verify bilge pump operation and float control
- 8. Check for engine / boat water leaks
- 9. RE-check fuel connections
- 10. Verify neutral safety switch operation
- 11. Check for presence of vibration
- 12. Verify lanyard switch operation (kill switch)
- 13. Verify instruments operate properly
- 14. Verify controls operate properly (IE; steering, shifter)
- 15. Verify options function properly (IE; heater, shower etc.)

I certify that all checks have been performed and completed, this vessel has been prepared in conjunction with Malibu Boats specifications. To ensure proper warranty status, Boat/ Engine MUST receive recommended maintenance schedule.

Technician Signature _____ Date _____

Service Contact _____ Phone _____

Customer Signature _____

PLEASE RETAIN IN CUSTOMER FILE FOR FUTURE REFERENCE



Required Maintenance Schedule Indmar Engines

Item No.	Service	First 10 hours	Every 50 hours	Every 100 hours	Annually
1.	Change engine oil and filter Pennzoil Marine 15W40, Pennz #PZ-3, AC PF-25	***	***		***
2.	Change transmission oil and filter Dextron III w/Mercon				***
3.	Change V-Drive oil SAE 30 motor oil				***
4.	Change fuel filter, Motor / Gas tank	***		***	***
5.	Change Spark plugs Indmar Engines MUST use AC MR43LTS				***
6.	Verify Engine timing 10 degrees advanced (base timing)	***			***
7.	Engine tune up (Cap, Rotor, Plugs)				***
8.	Clean for change flame arrestor			***	
9.	Inspect belts, hoses and clamps Tight?	***			***
10.	Shaft alignment Within .003	***			***
11.	Inspect spark plug wires				***
12.	Inspect Raw water pump impeller (change annually)			***	***
13.	Inspect rudder (lube, key-way, bolt tight)		***		***
14.	Inspect Prop Shaft Packing	***			***
15.	Inspect Steering Kit Assembly (Lube, bolts tight?)		***		***
16.	Check Engine Coolant (closed cooling only) 50:50 mix water w/ethylene glycol MUST meet GM 6038				***
17.	Propeller Tight (prop nut tight? key-way installed?)	***	***	***	***7
18.	Lubricate starter bendix (Lithium marine grease)		***		***



Corporate Headquarters

Malibu Boats
One Malibu Court
Merced, CA 95340
Phone: (209) 383-7469
Fax: (209) 383-0499

Tennessee Plant

Malibu Boats
5075 Kimberly Way
Loudon, TN 37774
Phone: (423) 458-5478
Fax: (423) 458-9052

Australian Headquarters

Malibu Boats
813 Hope Court
Albury, N.S.W. 2640
Phone: 026 040 1174
Fax: 026 040 4656

Internet:

www.malibuboats.com
info@malibuboats.com

Printed in U.S.A.

Ken Cook Co.