



**SPORTSMAN**

<https://www.boat-manuals.com/>

*Owner's Manual and  
Quick-reference Guide  
2017*

# Table of Contents



<i>Topic</i>	<i>Page</i>
Introduction	3
Important Information	4
Specifications	5
Overall Dimensions & Terminology	6
Features & Performance	7
Certifications & Registrations	12
Boating Safety	13
Electrical & Plumbing Systems	19
Fuel System	31
Boating Navigation Rules	36
Warranty & Services	37
Contact Information	40



# Introduction

## WELCOME TO THE SPORTSMAN TEAM!

Here at Sportsman Boats, we take great pride in producing the finest, most well designed saltwater fishing and pleasure boats on the market today. Our designs incorporate the most modern technology while applying good old “Common Sense” technology as well. From our advanced composite construction, ergonomic console designs, patented “Total Access” hatch, and superior ride and handling characteristics, we think you will agree that Sportsman is setting a new standard.

We do not take lightly the confidence you have placed in us with your decision to purchase your Sportsman boat. We will always strive to provide for you and your family the superior customer service you deserve. We hope that you enjoy your time out on the water as much as we enjoy building your Sportsman boat!

Safe Boating and Tight Lines,  
*Tommy Hancock and Dale Martin*

# SPORTSMAN

<https://www.boat-manuals.com/>



# Important Information

<b>BOAT INFORMATION / SPECIFICATIONS</b>	
MODEL:	HULL SERIAL #:
PURCHASE DATE:	DELIVERED:
IGNITION KEY #:	REGISTRATION #:
DRAFT:	WEIGHT:
VERTICAL CLEARANCE:	
<b>ENGINE / PROPELLER INFORMATION</b>	
ENGINE MAKE:	MODEL:
ENGINE SERIAL #:	
PROPELLER MAKE:	# OF BLADES:
DIAMETER / PITCH:	MODEL:
PART #:	
<b>OPTIONAL EQUIPMENT / OPTION PACKAGES</b>	
<b>TRAILER INFORMATION</b>	
MAKE:	MODEL:
SERIAL #:	GVRM:
ADDITIONAL INFORMATION:	
DEALER	SPORTSMAN
NAME:	PHONE:
PHONE:	REPRESENTATIVE:
SALES PERSON:	ADDRESS:
SERVICE MANGER:	
ADDRESS:	

We recommend filling out the information in this table and keeping one copy of this page in your personal records and one copy with your owner's manual. This information will be important should you need to contact your dealer or Sportsman Boats Manufacturing for technical assistance and/or service.

# SPORTSMAN

<https://www.boat-manuals.com/>

# Specifications



Length Overall	25'2"
Beam	9'2"
Draft	18"
Deadrise at Bow	50°
Deadrise at Transom	21°
Approximate Usable Fuel Capacity	147 gal.
Approximate Dry Weight	3900 lbs.
People Capacity	12 persons
Maximum Engine Horse Power	400 HP (4 Stroke)

**SPORTSMAN**

<https://www.boat-manuals.com/>

# Overall Dimensions & Terminology

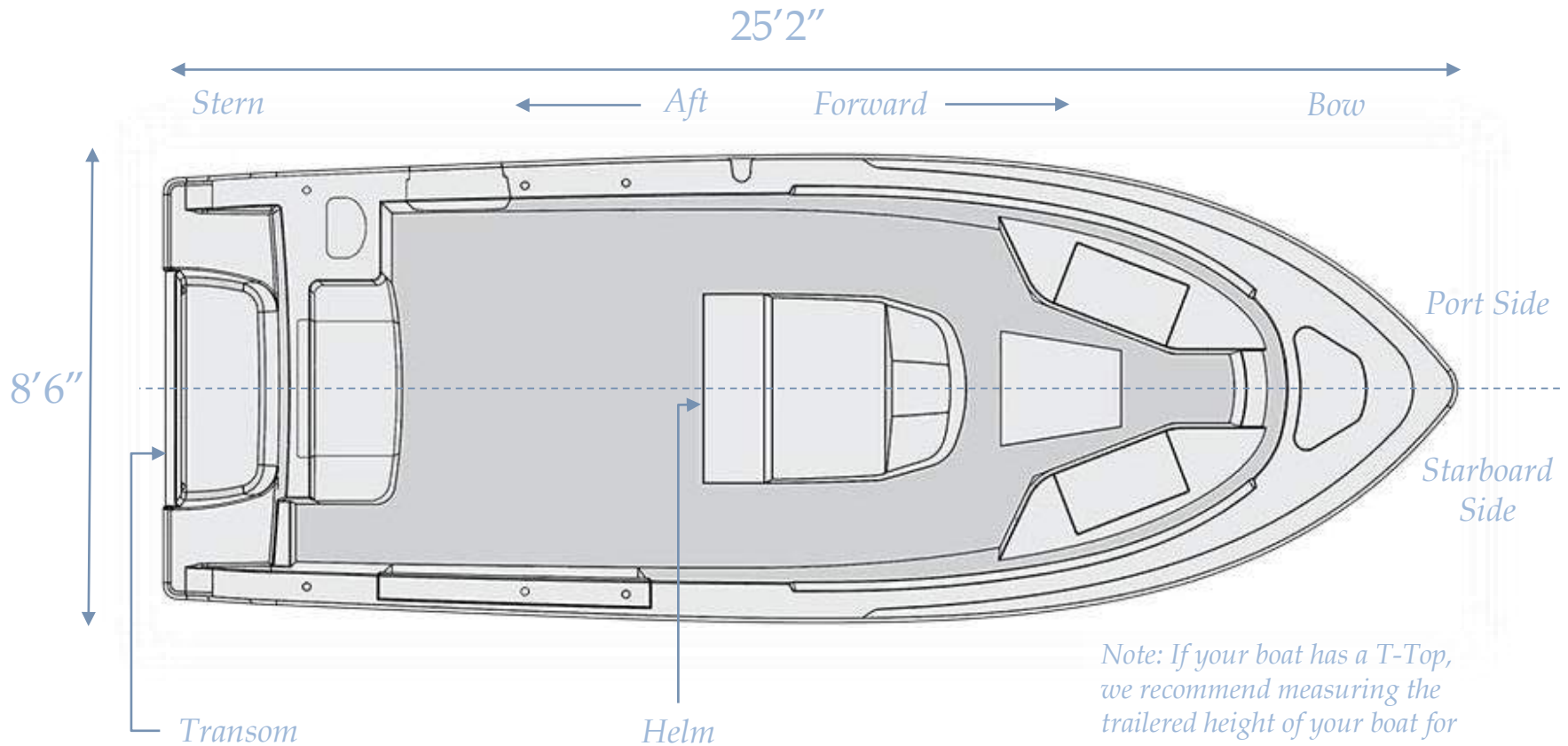

*Note: If your boat has a T-Top, we recommend measuring the trailered height of your boat for towing safety purposes. The approximate trailered height is 10'6". This height may depend on the specific trailer being used.*

# SPORTSMAN



# Features & Performance

## Standard Features

- 10 Year Hull Warranty
- 147 Approx. Usable Gallon Fuel Tank
- 12" Simrad GPS & Thru Hull Transducer
- 2 Power Plugs (12 Volt)
- 4 Flush-mounted Gunwale Rod Holders
- 2 Rear Livewells (30 Gallon)
- Fish Box with Macerator (80 Gallon)
- Console Cooler Seat (12 Gallon)
- All White Hull
- Anchor Windlass System with Anchor and 300' Line
- Bow Cushion Set with removable Filler Board
- Bow Bolsters
- Bow Storage
- Camel Cushions
- Console Footrest
- Compass
- Cockpit Drain Sumps (Self-bailing Cockpit)
- Dash Panel Cover
- Dual Battery Switch
- Fiberglass Hard Top with LED Lighting
- Fiberglass Leaning Post with 30 Gallon Livewell
- Freshwater Wash-down
- Grip Tex Yacht Style Non-skid
- High Speed Pick-ups (2)
- Horn
- Horizontal Under Gunwale Rod Storage
- Rub Rail Navigation Lights
- Interior LED Lighting Package
- Light Hull Color
- Lockable Console Storage with Porcelain Head
- NMMA Certified
- Matching Underside Color
- MB Quart Speaker System
- Misters
- Pull-up Cleats
- Raw Water Wash-down
- Rear Anchor Holder
- Rear Bench Seat with Cushions
- Rear Total Access Hatch
- Recessed Bow Rails
- Removable Bow Backrest
- 6 Stainless Steel Cup Holders
- Side Entry Door and Ladder
- Stainless Steel Drain Covers
- Stainless Steel Propeller
- Stainless Steel Rub Rail
- Stainless Steel Steering Wheel (with Knob)
- Strata Glass Spray Shield
- Swim Platform and Ladder
- Tilt Optimus Steering
- Trim Tabs
- Underwater Lights
- Windscreen

**SPORTSMAN**



# Features & Performance

## Optional Features

### Available Options

- Second 12" Simrad GPS
- Auto Pilot
- 4G Radar
- VHF Radio with Antenna (8')
- Structurescan Transducer
- Chirp B175M Transducer Upgrade
- GoFree iPad Add-on
- Sirius Weather
- Battery Charger
- Deluxe Leaning Post with Flip-up Bolsters, Slide-out Cooler, and Tackle Storage
- Dual Llebroc Seat on Fiberglass Leaning Post
- Dark Hull Color
- Fiberglass Leaning Post with Tackle Center
- Gull Wings
- Helm Pad
- Mooring Cover
- Optimus Power Steering
- Optimus 360 Joystick (Twin Engines Only)
- Powder Coating
- Powder Coating on Ski Tow Bar
- Release Marine Package
- Transhield Shipping Cover
- White Cushions

### Color Selection

- Driftwood
- Ice Blue
- Island Blue
- Jet Black
- Sea Mist Green
- Silver Cloud
- Steel Blue
- White

### Stereo Upgrade

- Four Channel Amp
- 8" Amplified Subwoofer

### Powder Coat Selection

- Black
- White

# SPORTSMAN





# Features & Performance

## Major Features

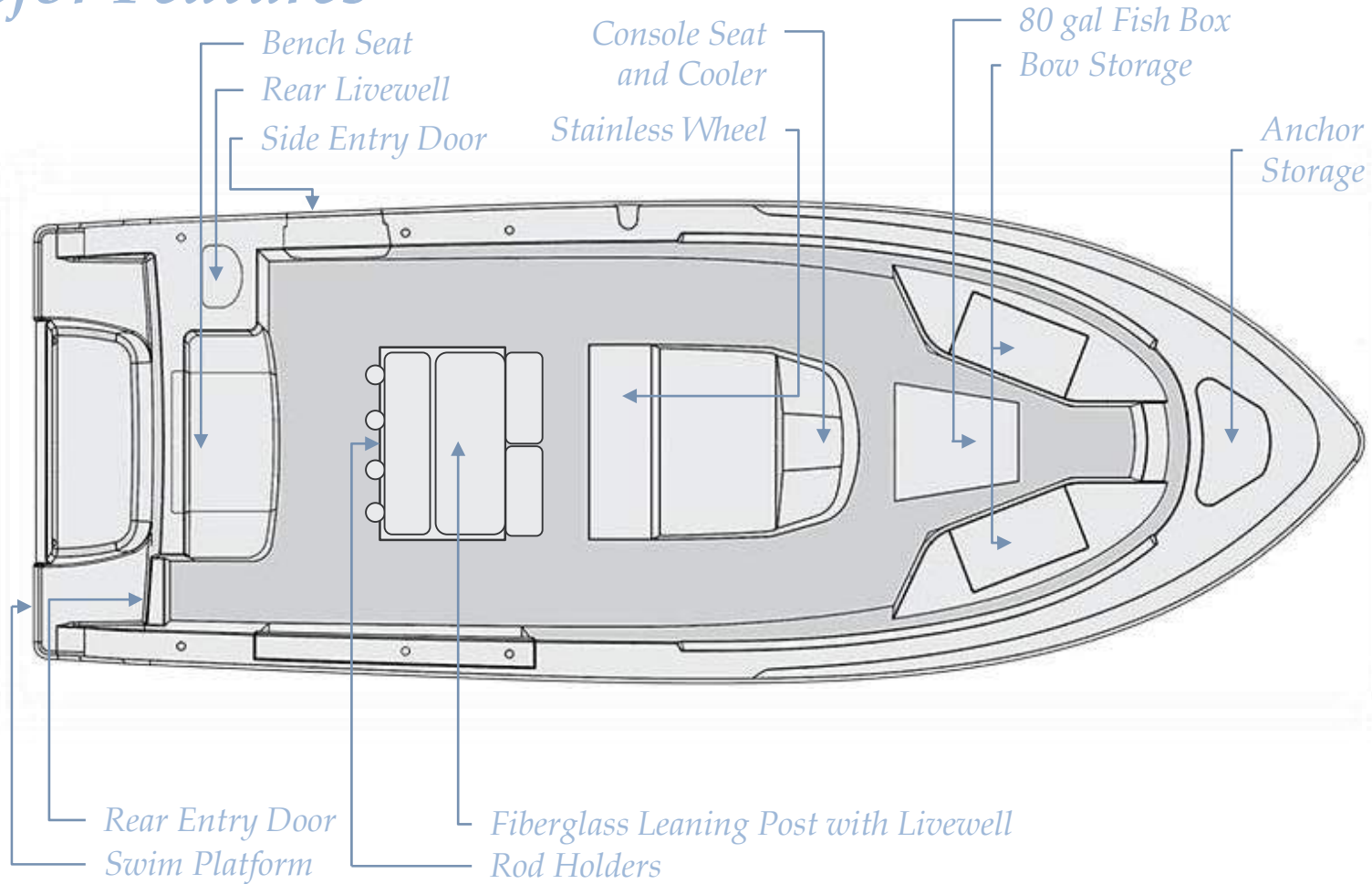

**SPORTSMAN**

# Features & Performance

## Twin 150 HP

## 300 HP



### PERFORMANCE BULLETIN

Model: FB\_SPT\_Heritage251\_L1190CA\_2014-01-24\_000

Year Range: 2014-15



**SPORTSMAN**  
Boat Manufactured By:  
Sportman Boats - 127-B Grand Lane - Summersville, SC 29162  
(803) 776-0000 - www.sportmanboats.com

**Dimensions\* Heritage 251**

Length	25'2"
Beam	8'2"
Dry Weight (without fuel)	4,185 lbs
Maximum HP	400
Fuel Capacity	188 gal
Weight as tested	5,588 lbs

**ENGINE**

Configuration	300 HP
Induction	87C
Displacement	4.3 L
Weight	481 lbs
Clearance	3.90

**ENGINE MOUNTING HEIGHT**

Mounting Plate Position	42
Mounting Plate Height	7.10" Above Boat Bottom

**PROPELLERS**

Series	Reference Series 200
diameter/ Pitch	18.1/15-11
Yamaha Part #	08F-40079 10-08 / 08C-40079 10-10
Propeller Material	Composite (Standard) (USA)

**TEST CONDITIONS**

Number of People	2
Air / Water Temperature (average)	85 / 70° F
Direction of Propeller as test	Sea Level
Wind Velocity	10-15 mph

**PERFORMANCE DATA**

RPM	MPH	GPH	MPG
1000	5.0	3.8	3.12
1500	7.1	2.9	2.78
2000	8.8	4.8	2.26
2500	11.3	6.4	1.77
3000	13.0	7.2	1.84
3200	15.0	8.5	2.18
4000	17.7	12.4	2.58
4500	18.1	15.4	2.38
5000	19.4	19.1	2.18
5500	19.5	24.9	1.84
6100	20.2	33.0	1.58

0-50 MPH: 8.20



**Notes:** The information and data contained in this Performance Bulletin is preliminary and subject to change without notice. Conditions are subject to change and should not be used for comparison of other performance data. Performance data is based on a standard test procedure and is not intended to be used for comparison of other performance data. Performance data is based on a standard test procedure and is not intended to be used for comparison of other performance data. Performance data is based on a standard test procedure and is not intended to be used for comparison of other performance data.

**For More Information:**  
Contact Your Dealer or Yamaha U.S.A.  
14800 South Greenway, Suite 100  
Tomball, TX 77375  
Tel: 281-291-2200 (toll-free), 281-291-2200 (TX)  
www.yamaha-usa.com

### PERFORMANCE BULLETIN

Model: FB\_SPT\_Heritage251\_L1190CA\_2014-01-24\_000

Year Range: 2014-15



**SPORTSMAN**  
Boat Manufactured By:  
Sportman Boats - 127-B Grand Lane - Summersville, SC 29162  
(803) 776-0000 - www.sportmanboats.com

**Dimensions\* Heritage 251**

Length	25'2"
Beam	8'2"
Dry Weight (without fuel)	4,185 lbs
Maximum HP	400
Fuel Capacity	188 gal
Weight as tested	5,659 lbs

**ENGINE**

Configuration	300 HP
Induction	87C
Displacement	4.3 L
Weight	475 lbs
Clearance	1.75

**ENGINE MOUNTING HEIGHT**

Mounting Plate Position	42
Mounting Plate Height	7.10" Above Boat Bottom

**PROPELLERS**

Series	Reference Series 1000
diameter/ Pitch	18-1/2 x 11
Yamaha Part #	08C-40079-00-00
Propeller Material	Polished Stainless Steel

**TEST CONDITIONS**

Number of People	2
Air / Water Temperature (average)	85 / 70° F
Direction of Propeller as test	Sea Level
Wind Velocity	10-15 mph

**PERFORMANCE DATA**

RPM	MPH	GPH	MPG
1000	5.0	3.0	4.30
1500	7.6	2.1	3.62
2000	8.8	2.5	3.51
2500	12.9	3.2	2.46
3000	15.6	3.0	2.91
3200	17.1	3.3	3.02
4000	21.4	10.9	3.72
4500	20.0	15.1	3.10
5000	19.0	18.5	2.50
5500	18.3	23.9	2.10
6000	18.1	28.0	1.88

0-50 MPH: 8.21



**Notes:** The information and data contained in this Performance Bulletin is preliminary and subject to change without notice. Conditions are subject to change and should not be used for comparison of other performance data. Performance data is based on a standard test procedure and is not intended to be used for comparison of other performance data. Performance data is based on a standard test procedure and is not intended to be used for comparison of other performance data.

**For More Information:**  
Contact Your Dealer or Yamaha U.S.A.  
14800 South Greenway, Suite 100  
Tomball, TX 77375  
Tel: 281-291-2200 (toll-free), 281-291-2200 (TX)  
www.yamaha-usa.com

Note: This is posted on our website at <http://sportsmanboatsmfg.com/heritage-251-center-console/>



<https://www.boat-manuals.com/>

# Features & Performance



## Twin 200 HP

**PERFORMANCE BULLETIN** **YAMAHA**

YAMAHA PE\_251\_1page(251)\_1\_F03E00A\_2014-02-12\_000

YAMAHA PE\_251\_1page(251)\_1\_F03E00A\_2014-02-12\_000



**S SPORTSMAN**

Star Manufactured By:  
2001010000-1 (4-8 20010 LHS) (307)1010 30 CH02  
847-476-0000 [www.sportsmanboatsmfg.com](http://www.sportsmanboatsmfg.com)

**PERFORMANCE DATA**

RPM	MPH	GPH	MPG
1000	4.0	1.8	2.22
1500	7.1	3.4	2.09
2000	10.7	4.8	2.23
2500	13.7	5.9	2.33
3000	16.3	6.7	2.43
3500	19.7	8.3	2.37
4000	23.7	10.0	2.37
4500	28.5	11.7	2.43
5000	32.9	13.1	2.51
5500	37.9	14.6	2.60
6000	42.8	16.7	2.57

Stroke: 1000  
RPM: 4.80



**SPORTSMAN Heritage 251**

Length: 20' 0"

Beam: 8' 0"

Dry Weight (w/o fuel): 4,930 lbs

Maximum HP: 400

Fuel Capacity: 340 gal

Weight as Fitted: 8,104 lbs

**EXCESSIVE WEIGHTS**

Horsepower: 200 HP

Inclusive: 0%

Maximum: 2.8%

Weight: 400 lbs

Gear Ratio: 1.86

**ENGINE MOUNTING HEIGHT**

Mounting Hole Position: 40

Weighted Hole Height: 1-1 1/4" Above Base Location

**PROPELLERS**

Series: Reference Series-000

Maximum Pitch: 14-1/4" x 18"

Yamaha Part # 99F-40076-10-00 / 000-41870-10-00

Propeller Material: Polished Stainless Steel

**TEST CONDITIONS**

Number of People: 0

Air / Water Temperature (Water - Surface): 72 / 70° F

Electrical (w/ accessories on): Off / Low

Wind Velocity: 0-10 mph

Notes:

Notes to Operator:

For more information:  
Yamaha Boats Corporation, U.S.A.  
Attention: Sales Policy  
1270 Oyster Point Rd.  
Farmingdale, NY 11735-1000  
For other Performance Bulletin, visit [www.yamaha.com](http://www.yamaha.com)

© 2014 Yamaha Motor Corporation, U.S.A. All Rights Reserved.

# SPORTSMAN

<https://www.boat-manuals.com/>

Note: This is posted on our website at  
<http://sportsmanboatsmfg.com/heritage-251-center-console/>



# Certifications & Registrations

## *NMMA Certification*

Sportsman Boats is certified by the National Marine Manufacturers Association (NMMA). NMMA certification not only meets the standards of the United States Coast Guard (USCG), but goes further to meet the standards set by the ABYC (American Boat and Yacht Counsel). All Sportsman models have been designed, constructed, and thoroughly tested to meet or exceed these standards. For more information about these standards, you may visit <http://www.nmma.org/certification/boats>.

## *Hull Identification Number & Registration*

Sportsman has a permanent record of your boat. This record is documented during the manufacturing process. It is identified by its "Hull Identification Number" (HIN). **The HIN is a 12-digit code located on the starboard side of the transom, just under the Rub Rail.** When contacting your dealer concerning maintenance or warranties, please have your HIN and model number available. This information can be found on your copy of the warranty card. Federal and State laws require a power boat to be registered in the state where it is primarily used. Registration numbers and validation stickers must be displayed according to regulations. The registration certificate must be on board when boating. The boat serial number, or Hull Identification Number (HIN), is required on the registration form. The HIN should be included on all documents or any correspondence.

**SPORTSMAN**

# Boating Safety



## LIGHTING

Your Sportsman boat is equipped with navigation lights which comply with both Inland and International rules.

## FIRE EXTINGUISHER

At least one Type-1 hand held portable fire extinguisher must be carried on board. For boats over 20' two are required. Check extinguisher regularly for charge status.

## REQUIRED SAFETY EQUIPMENT

The US Coast Guard (USCG) requires that every boat have specific equipment on board. Check with local regulations on mandatory equipment apart from the list of Coast Guard requirements.

## SOUND SIGNALING DEVICES

Your Sportsman boat is equipped with an electric horn which meets the USCG requirements for a sound signal device.

## PERSONAL FLOTATION DEVICE (PFD)

You must have a USCG approved personal flotation device of Type I, II, or III aboard for each passenger, in addition to one Type IV throw able PFD. **Always wear a PFD when boating.** In some states, children are required to wear a PFD at all times. Check your local regulations.

## VISUAL DISTRESS SIGNALS

USCG approved visual distress signals are required for day and night use when operating on US waters. Approved signals include flares, orange smoke, an orange distress flag, or an electric distress light.

# SPORTSMAN

# Boating Safety



Being on the water is a great experience, but it can become a bad experience very quickly if safety and maintenance instructions of your boat are not followed. Therefore, warnings and notices have been included in order to help you operate and maintain your boat safely. They are defined as follows:

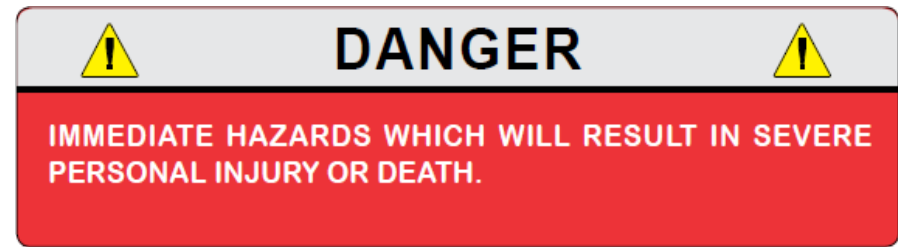
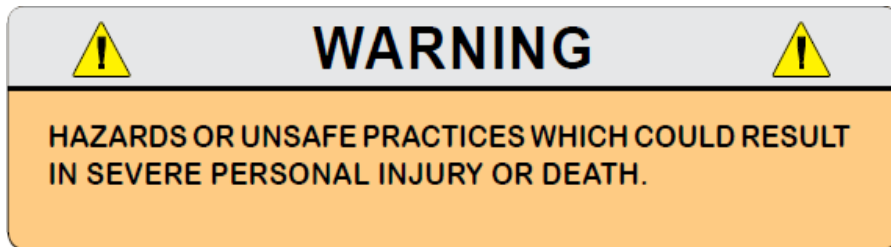

Please become familiar with the location and content of the Caution, Warning, and Danger Labels found on your boat.

# Boating Safety



Your Owner's Manual was written to include safety instructions to ensure safe operations. Safety alert symbols are used to show potential personal injury hazards.

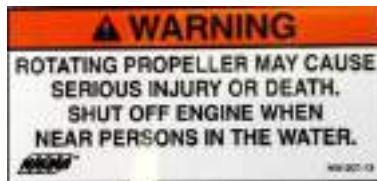
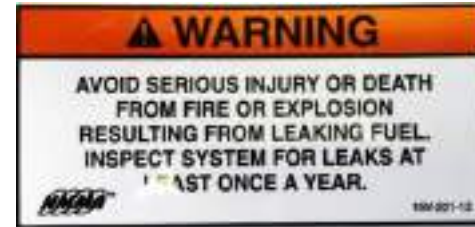

Every precaution has been taken to reduce the risks associated with death, possible injury and damage from fire or explosion. You must also take your own necessary precautions and practice proper maintenance procedures in order to enjoy the optimal safe operation of your boat.

*If your label is damaged. Please call Sportsman's parts department for replacement stickers.*



# Boating Safety

Your boat produces carbon monoxide and uses flammable fuel. Carbon monoxide can cause brain damage or death. Carbon monoxide is colorless, odorless and extremely dangerous.

**⚠ DANGER**



**Carbon monoxide (CO) can cause brain damage or death.**  
Engine and generator exhaust contains odorless and colorless carbon monoxide gas.  
Carbon monoxide will be around the back of the boat when engines or generators are running.  
Move to fresh air, if you feel nausea, headache, dizziness, or drowsiness.

NW-206-13

**⚠ WARNING**



**Carbon monoxide (CO) can cause brain damage or death.**  
Engine and generator exhaust contains odorless and colorless carbon monoxide gas.  
Signs of carbon monoxide poisoning include nausea, headache, dizziness, drowsiness and lack of consciousness.  
Get fresh air if anyone shows signs of carbon monoxide poisoning.  
See Owner's Manual for information regarding carbon monoxide poisoning.



# Boating Safety Label Locations



## MAXIMUM CAPACITIES

**12 PERSONS OR 2160 LBS**

200 POUNDS, PERSONS, MOTOR, GEAR  
Etc. - DOES NOT INCLUDE WATER

DESIGN COMPLIANCE WITH U.S. COAST GUARD SAFETY  
REGULATIONS BY PLAN OF CONSTRUCTION

MANUFACTURED BY Sportsman Boat Manufacturing, Inc.  
MODEL: Heritage 251 Summerville, SC

DESIGN COMPLIANCE WITH FEMA REQUIREMENTS RELAY IS CERTIFIED  
MANUFACTURED IN ACCORDANCE WITH FEDERAL FIRE CODES



NATIONAL MARINE MANUFACTURING ASSOCIATION

**MEETS U.S. EPA EVAP  
STANDARDS USING  
CERTIFIED COMPONENTS**

Sportsman Boats Mfg. Summerville, SC

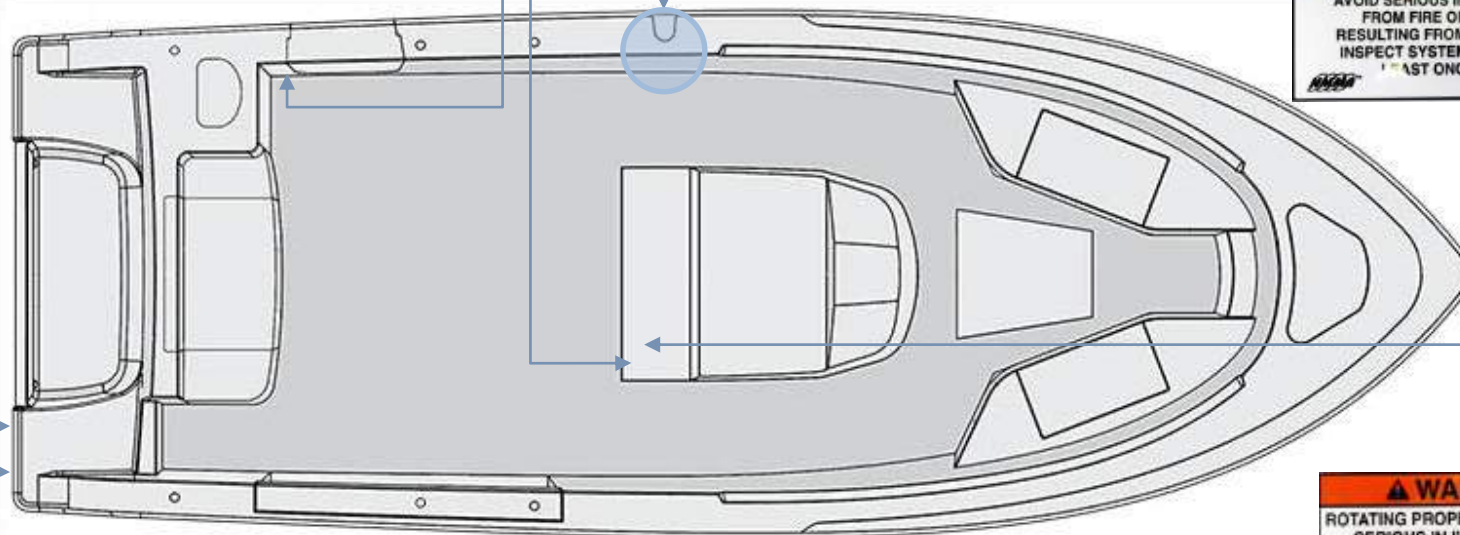
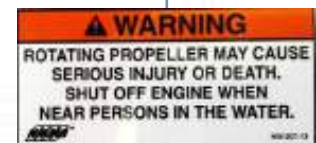
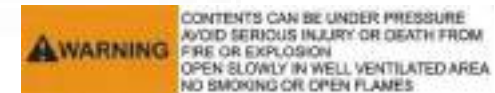
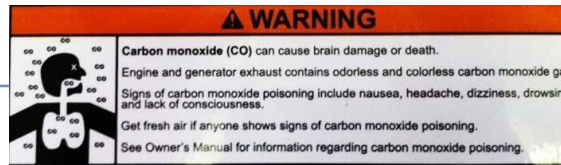
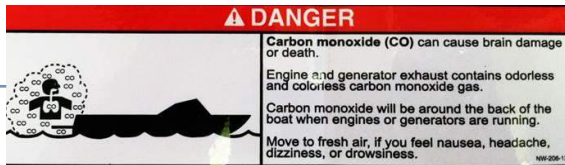
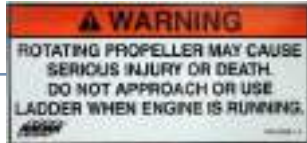

# SPORTSMAN

# Boating Safety



The Sportsman Heritage 251 has a 12 Person Capacity. Seating locations are shown below.

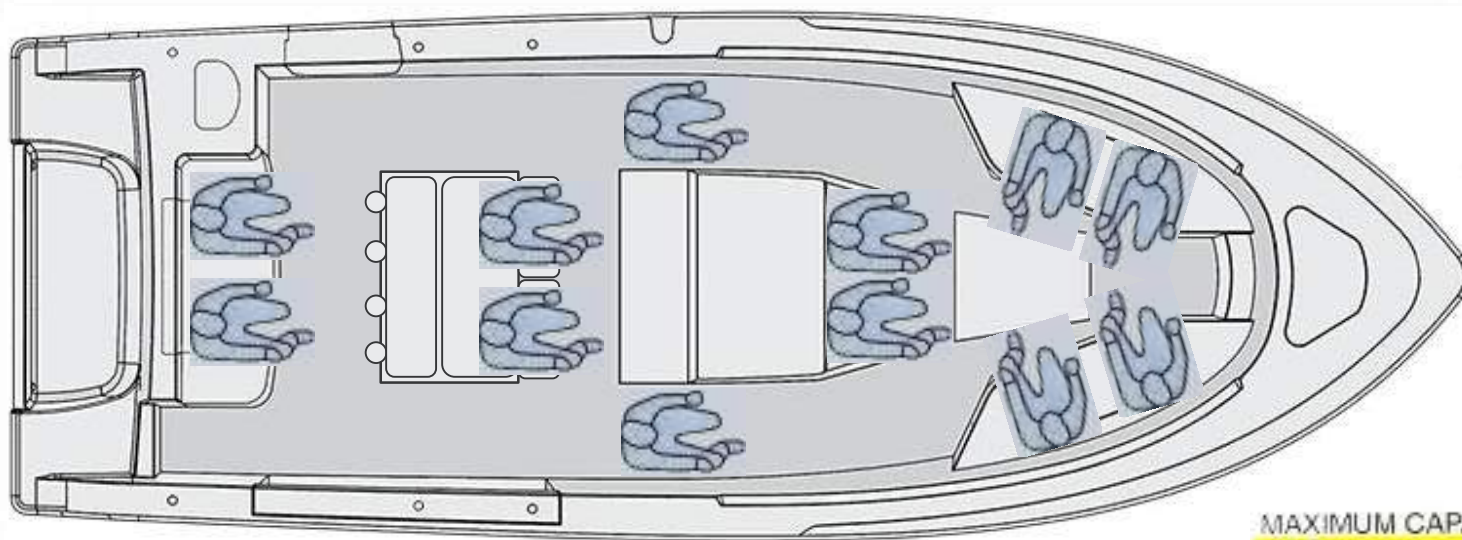

**MAXIMUM CAPACITIES**  
**12 PERSONS OR 2160 LBS.**  
2160 POUNDS, PERSONS, MOTOR, GEAR  
ETC. - HONDA POWER MOTOR

2011 BOAT COMPLIES WITH U.S. COAST GUARD SAFETY  
REGULATIONS TO TRAVEL ON THE GULF OF CALIFORNIA

MANUFACTURED: Sportsman Boat Manufacturing, Inc.  
MODEL: Heritage 251  
Sarasota, FL

DESIGN COMPLIANT WITH NADA REQUIREMENTS RELATIVE TO CAPACITY  
MANUFACTURED IN ACCORDANCE WITH U.S. COAST GUARD SAFETY REGULATIONS

**NADA**  
CERTIFIED  
BY NADA  
NATIONAL MARINE MANUFACTURERS ASSOCIATION

# SPORTSMAN

<https://www.boat-manuals.com/>

# Electrical & Plumbing Systems

## Wire Harness

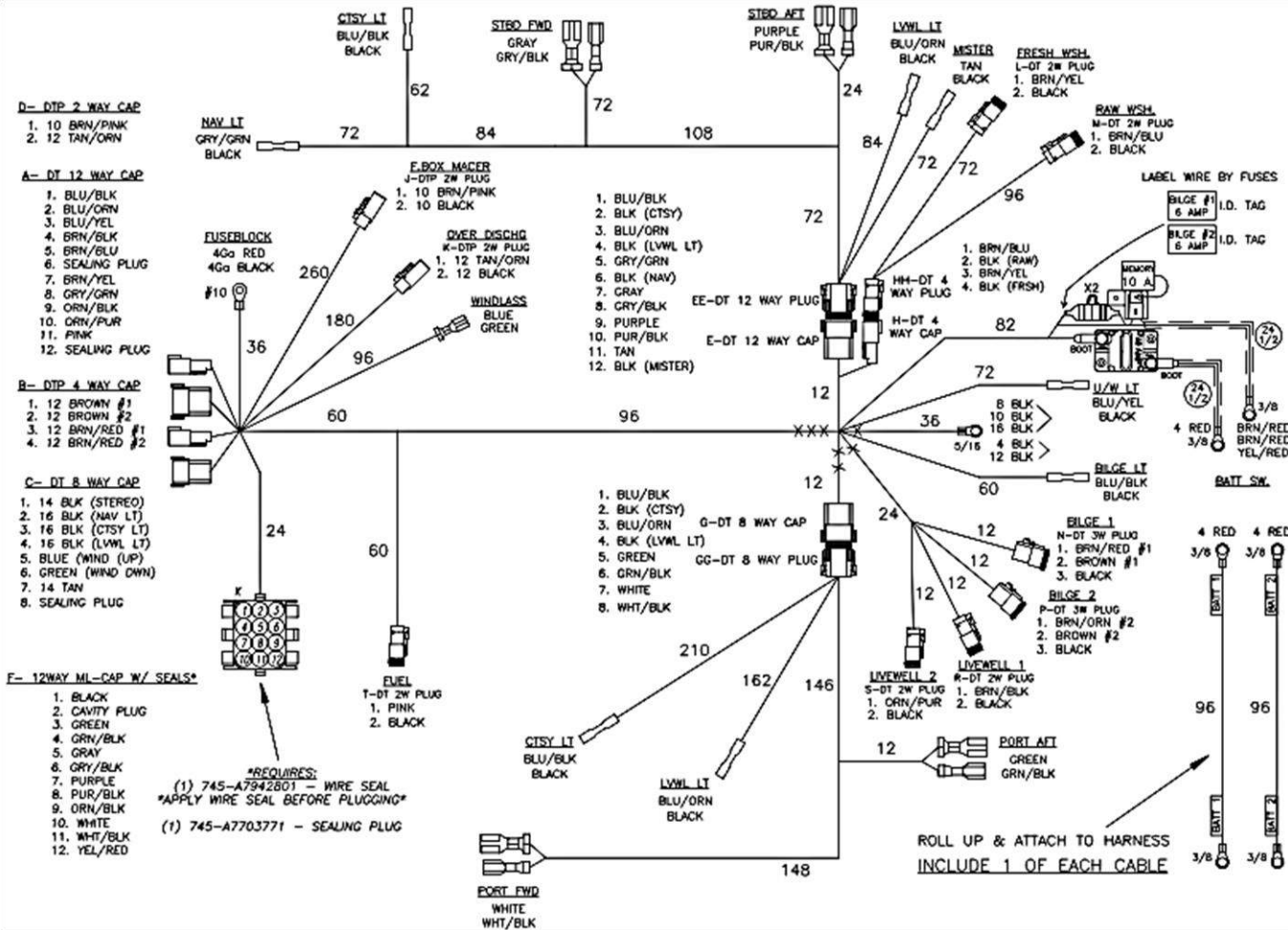

Fuse Panel

The fuse panel is located under the console. It is clearly labeled for easy identification. The bilge pump's 6 amp fuse is also located here. There is also a 30 amp breaker branching off the main battery switch. **If an electrical component of your boat stops working properly, this should be the first place to look.**

# Electrical & Plumbing Systems

## Simrad 12" Package



Sportsman offers the Simrad NSS EVO2 Multi-function display, which integrates the following functions of the boat:

- Structure Scan Capability
- Sonic Hub Stereo
- Sonar
- Radar Capability
- Navigation
- Engine Instruments
- Coastal Charts



# SPORTSMAN



# Electrical & Plumbing Systems

## Simrad 12" Package (cont'd)

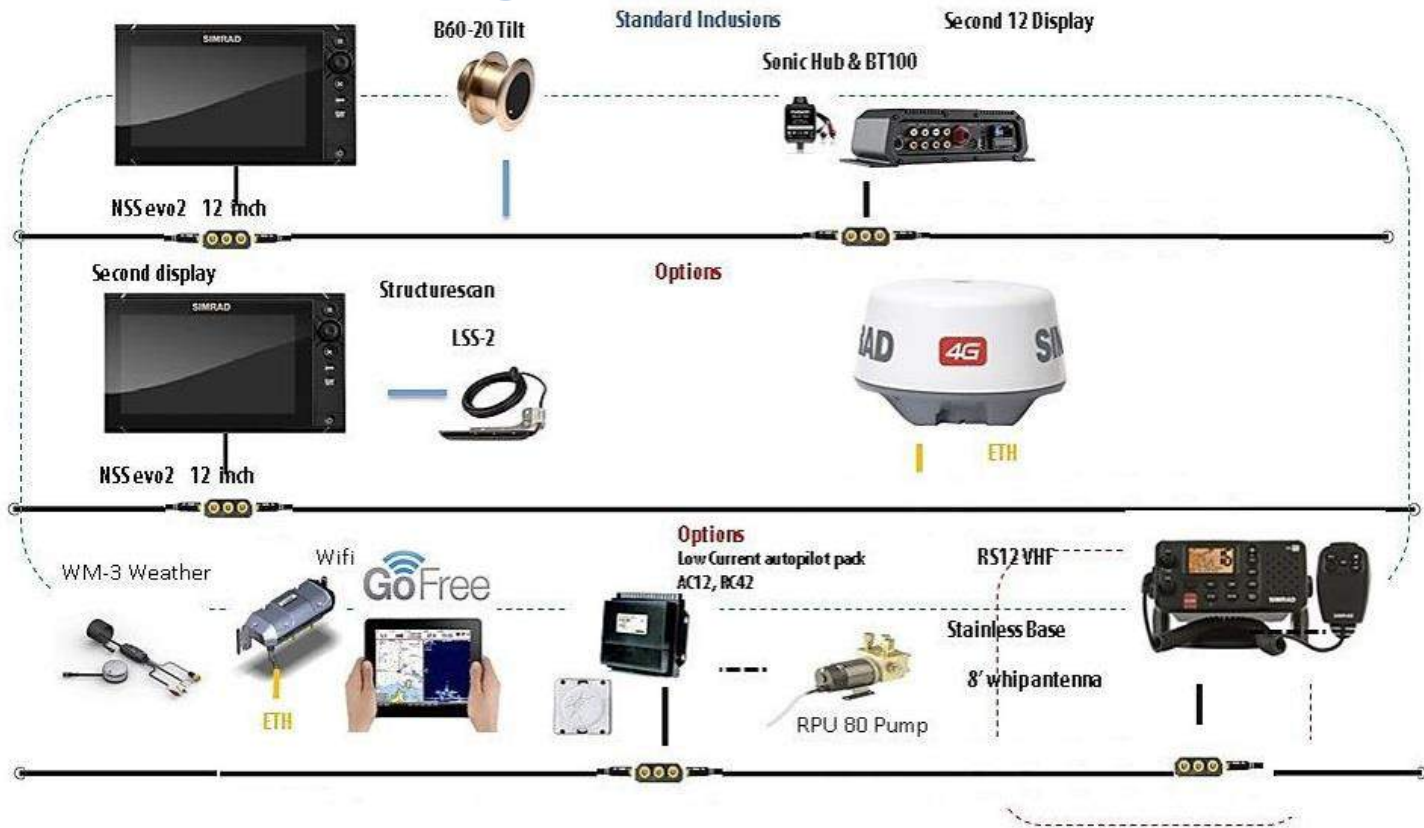

The Sportsman Heritage 251 includes a 12" Simrad unit as a standard feature. The transducer is located on the hull bottom at the stern of the boat. The SonicHub system is another standard feature of the Heritage 251 and is located on the inside wall of the console. The SonicHub system is controlled through the Simrad unit.



# Electrical & Plumbing Systems

## Optimus Electronic Power Steering

SeaStar's Optimus Electronic Power Steering (EPS) is at the forefront of boating technology. This system provides both the most comfortable and versatile maneuverability for your boat. When running at speed in open water, the steering system can be set to increase lock-to-lock turns to increase steering effort so the driver can effortlessly stay on course. At low speeds, Optimus may be adjusted for reducing the number of turns lock-to-lock. This will increase the sensitivity of the steering and enable tight, precise movements necessary for navigating through heavy traffic areas and tight spots. Optimus allows the boat to adapt to the environment as necessary to give the driver the most comfortable and pleasant experience possible.



**SPORTSMAN**



# Electrical & Plumbing Systems

## Optimus 360 Joystick Option

Sportsman offers the Optimus 360 as an option on the Heritage 251. This joystick significantly enhances the boat's maneuverability and ease of use at low speeds, such as pulling in or out of a slip. This allows you to move the boat sideways by pushing the stick left or right; you can also use this to rotate the boat about a point by twisting the joystick. It does this by moving each motor independently from one another at differing speeds and directions, as seen in the image below. To provide the smoothest possible motions and intuitive controls, the Optimus 360 is programmed to minimize the amount of shifting when practicing tight maneuvers. It also uses progressive throttling, which means a lighter push or twist will result in a slower, more precise motion than that of a strong push or twist. This system works seamlessly with the boat's components to give you total control when docking and navigating through tight areas.



# Electrical & Plumbing Systems

## Lights

The *NAV/ANC Switch* is a 3-position switch on the console that controls the running lights.

- **NAV** position will turn on the red and green navigation lights and the white all-round light for night driving.
- **ANC** turns on the all-round light only for night anchoring. Do not operate the boat in anchor position.
- Off is in the center position.

**Sidelights:** The Heritage 251 has integrated rub rail navigational lights installed at the bow (see figure to the right). A green light is located on the starboard (right) side and a red light on the port (left) side of the vessel. Each shows an unbroken light over an arc of the horizon of 112.5 degrees and is fixed to show from ahead to just behind the beams of the vessel on its respective side.

**All-round/Anchor Light:** This is a white light placed over the highest unobstructed point of the vessel, showing an unbroken light over an arc of the horizon of 225° and fixed to show from anywhere ahead, to just behind the beams of the vessel. See the figure to the right for location.

Recreational boats are required to display navigation lights between sunset and sunrise and other periods of reduced visibility (fog, rain, haze, etc.) Navigation lights are intended to keep other vessels informed of your presence and course. Your boat is equipped with the navigation lights required by the U.S. Coast Guard at the time of manufacture. It is up to you to make sure they are visible, operational and turned on.



### Bow Sidelights

If you have the underwater lights option installed, they can be turned on with the switch at the helm labeled "Accessory 1."

The anchor light on the Heritage 251 is located on the aft end of the T-Top. The location of the light is shown here without a visible T-Top.

### Anchor Light

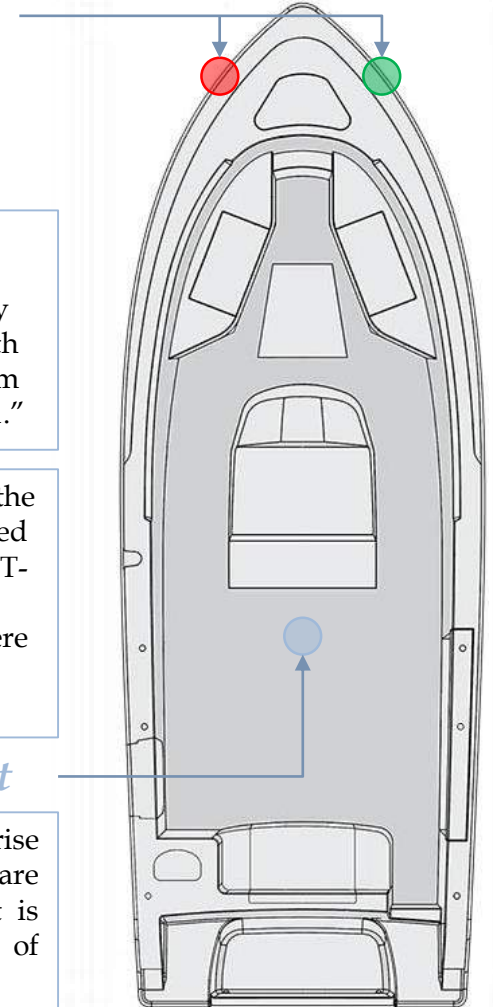



# Electrical & Plumbing Systems

## Stereo

If your boat has the stereo option, it comes with a SonicHub stereo system. The speaker locations are shown below. The SonicHub system is located inside the console. The stereo system interfaces with the Simrad unit at the helm, so that it can be controlled through the Simrad unit as a central hub and leave more open space on the console. If you purchased the stereo upgrade option, this comes with MB Quart speakers, a four channel amplifier, and an 8" subwoofer.



### SonicHub System



### Speakers

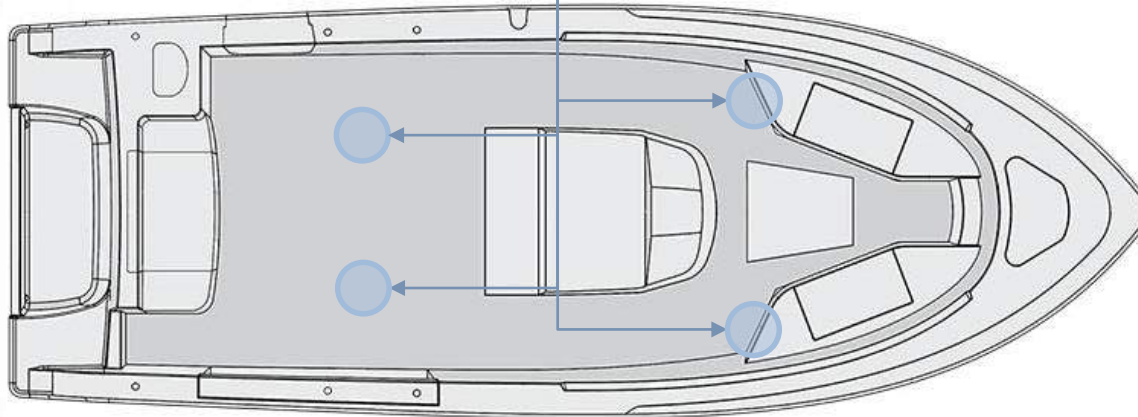

The aft pair of speakers (the left two speakers in the figure to the left) are located on the T-Top underside.

# Electrical & Plumbing Systems

## Trim Tabs

Your Heritage 251 has trim tabs installed as a standard feature. They are attached to the bottom edge of the transom, as shown in the image below. When the trim tabs control at the helm (pictured to the right) is pressed, the trim tabs automatically move into position. The force of passing water on these tabs results in upward pressure at the transom, which will lower the bow. This helps to improve the performance of the boat in a wide range of weight, weather, and water conditions.

The LEDs on the control panel indicate the position of the tabs. If all are lit up, that tab is all the way down. The port and starboard tabs may be operated independently if necessary. To lower the starboard bow, lower the port tab. To lower the port bow, lower the starboard tab. The lights on the left indicate the port tab position, and the lights on the right indicate the starboard tab position.



Control Panel

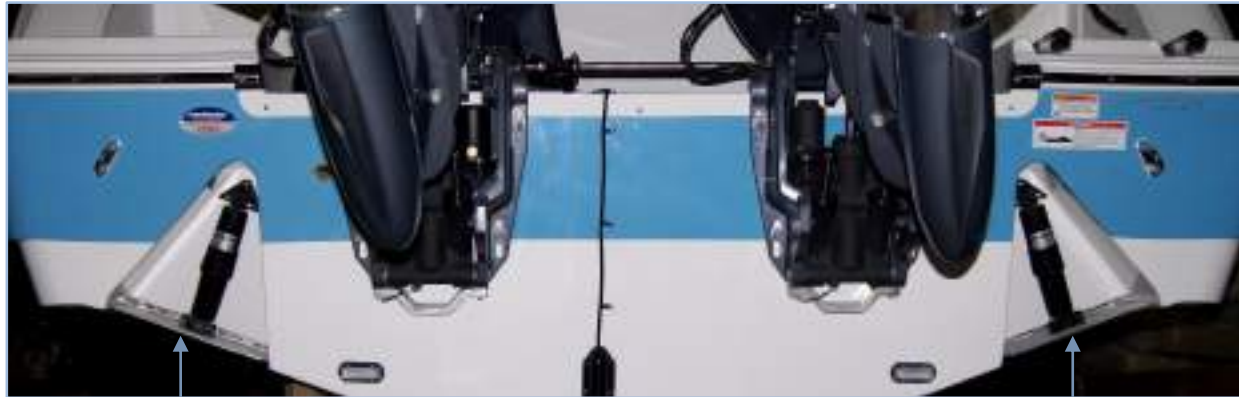

Trim Tabs



# Electrical & Plumbing Systems

## Trim Tabs

***If you keep your boat in a wet slip/marina environment. Here is a list of different anodes recommended for various water types to prolong the life and shine of your stainless steel tab. Never use a wire brush to clean your tab***

### **Zinc Alloy Anodes = Salt water only**

Not recommended for use in fresh water

Alloy is manufactured to meet or exceed US Military Specification (MIL-A-18001K)

### **Aluminum Alloy Anodes = Salt or Brackish water**

Not recommended for use in fresh water

Proven to last longer than zinc due to increased capacity

Alloy is manufactured to meet or exceed US Military Specification (MIL-A-24779(SH))

### **Magnesium Alloy Anodes = Fresh water only**

Not recommended for use in salt or brackish water

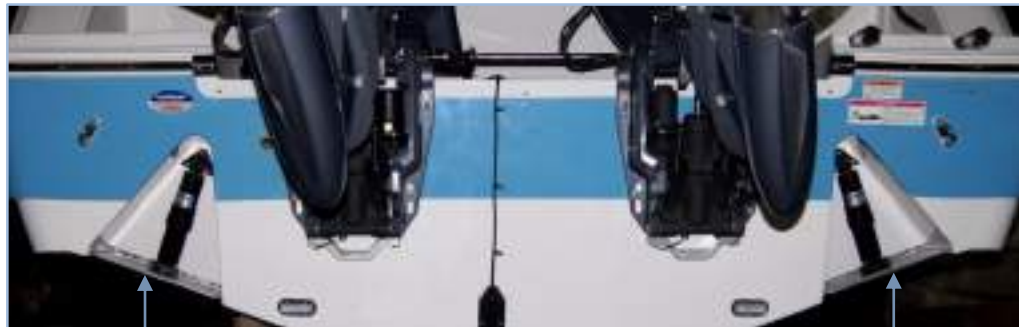

*Trim Tabs*

**SPORTSMAN**

# Electrical & Plumbing Systems

## Bilge Pumps

Two small bilge pumps are located on the hull bottom at the stern of your boat. Water is pumped out of thru-hull fittings located on the port and starboard sides of the boat near the transom. The pumps may be accessed by removing the aft seat and door, in the area shown to the right. You may turn your bilge pumps on manually by flipping on a bilge switch located on the switch panel at the helm. Additionally, the bilge pump utilizes a float as an automated switch to turn it on automatically if necessary when the boat is unattended. The bilge pumps are designed to remove excess water **only**, and they are **not** intended to stop or prevent rapid accumulation of on-board water due to rough weather, hull damage, or any other unsafe navigational conditions.

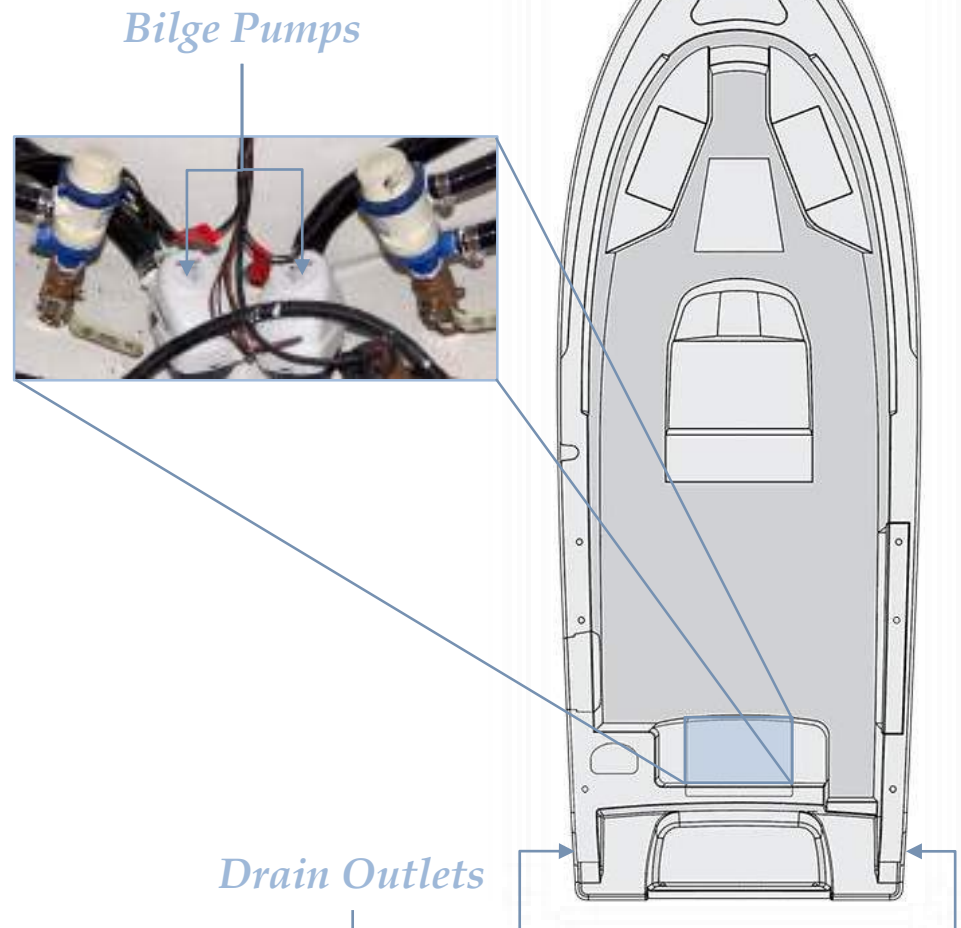

# Electrical & Plumbing Systems

## Livewells

The Sportsman Heritage 251 comes with two 30 gallon livewells: one at the port stern of the boat and one built in to the leaning post. For easy access to the pumps and plumbing systems, open the total access hatch forward of the transom. The livewell pumps are located on either side the bilge pumps in the hull of the boat, and the livewell fill hoses are connected to the top of the pumps. To operate the livewells, open the pump valve in the bilge, turn on the livewell switch at the helm, and turn the fill valve in the livewell to "open." The switch labeled "Livewell 1" fills the leaning post livewell, and the switch labeled "Livewell 2" fills the stern livewell. Both livewells are equipped with overflow drains so water cannot exceed a certain level and overflow. These overflow drains are connected to the main drain lines at "T" joints, which empty out an outlet drain at the stern of the boat. Additionally, each livewell has LED lighting installed. To illuminate the livewells, turn on the switch at the helm.

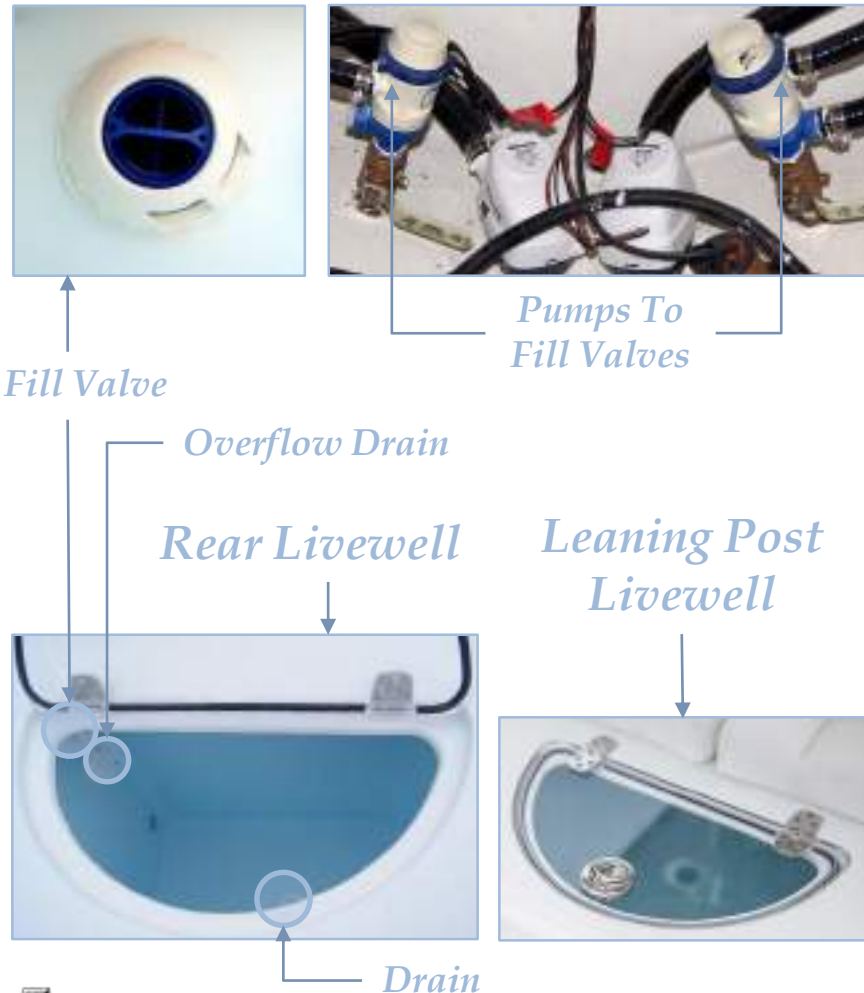

# Electrical & Plumbing Systems

## Raw Water Wash-down

Your Heritage 251 has the raw water wash-down installed as a standard feature. Rinsing your boat immediately after use with a powerful water jet helps to maintain the boat's condition and value. This system supplies water via a hose connected to bottom of the same pump that supplies water to your livewells with a shut off valve in the bilge area at the total access hatch. To operate the wash-down system, start by opening the valve mentioned above. Then turn on the switch labeled "WASHDOWN" on the switch panel at the helm. The wash-down outlet is found on the starboard side of the boat under the gunwale. See the figures here for important feature locations for the raw water wash-down system.

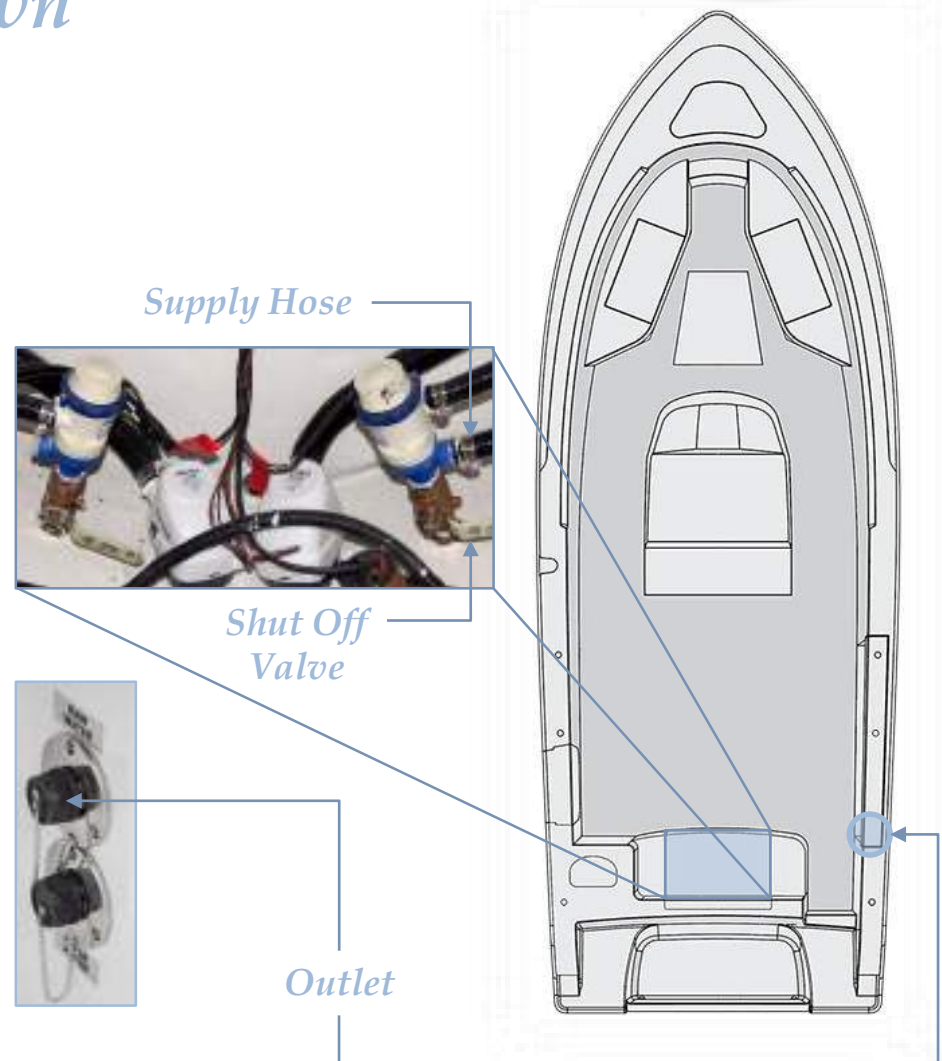

# Electrical & Plumbing Systems

## Fresh Water Wash-down



Your Heritage 251 has the freshwater wash-down installed as a standard feature. The freshwater fill fitting is located at the stern of the boat on the starboard side. The tank is underneath the deck near the swim platform. **Do not leave the tank full if your boat will be left unattended for an extended period of time;** pump the tank dry to avoid stagnant water in the tank if necessary. It is also important to periodically inspect and clean the filter, which is located on the pump. To operate this system, turn on the switch labeled "ACCESSORY 2" at the helm. This will pressurize the system for use. When the tank is empty or the boat is not in use, ensure that this switch is in the off position.

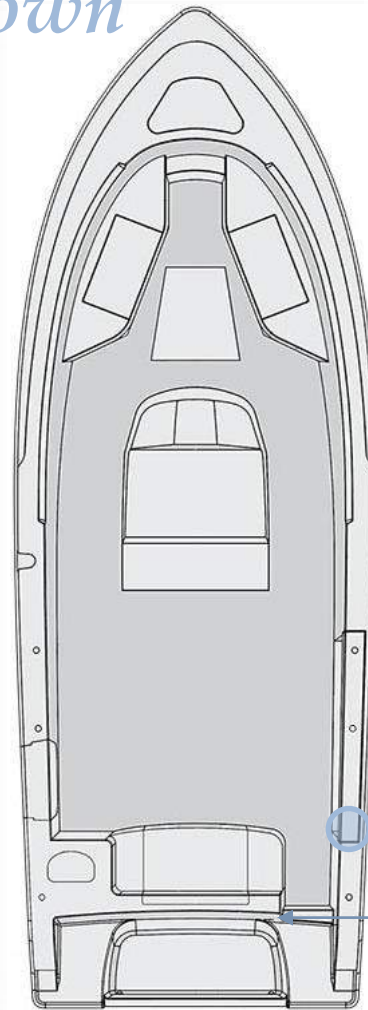

Outlet

Fill



# SPORTSMAN

# Fuel System

## Fuel Tank

The Sportsman Heritage 251 comes with a fuel tank installed (147 approximate usable gallon capacity). The gasoline fuel system consists of a fuel tank (located underneath the helm seat as shown in the figure), anti-siphon valve, engine fuel supply line, and fill cap. Your boat contains a new EPA certified fuel system. The system prevents spit-back when filling the tanks and lowers the out gassing emissions through a vent in the new designed fuel fill cap.

*Note: This photo was taken during the assembly process. At this stage, some of the hoses had not yet been connected. In your boat all lines and hoses will be connected as necessary.*

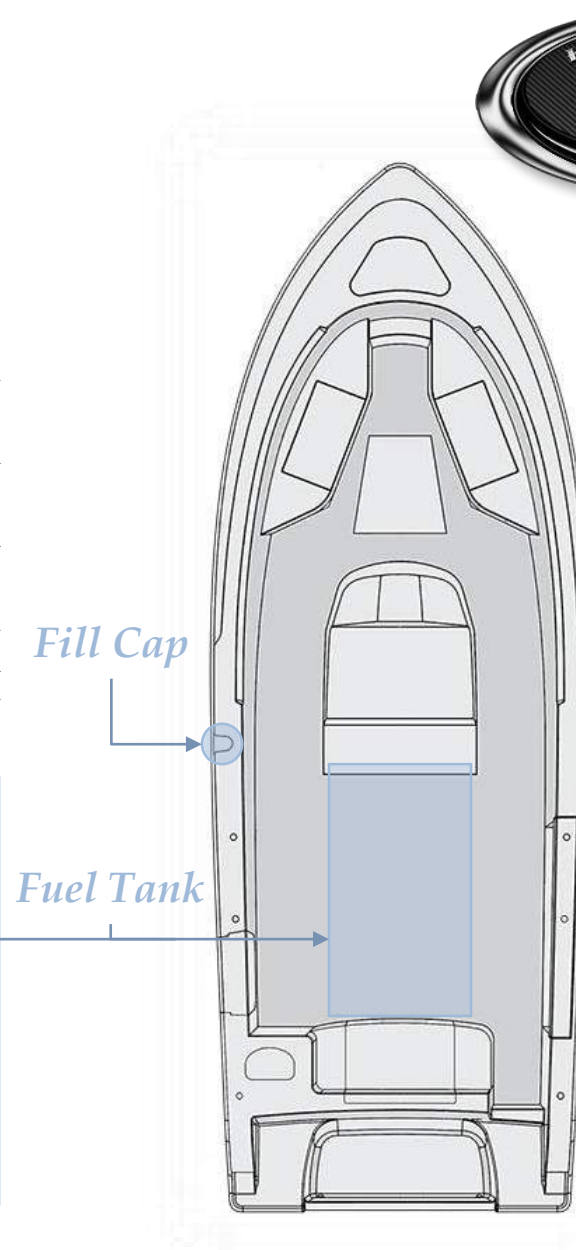



# Fuel System

## Diurnal Fuel System



**BluSkies**

## EPA DIURNAL FUEL SYSTEMS

**NOTE: Pressure may be present when opening your deck fill, regardless of system type.**



### **Only open the fuel cap for refueling**

Note: The first time fuel is introduced to a fuel tank, be aware of the interaction of cold raw fuel vapors replacing air, on occasion a vapor pressure can occur producing spit-back anomalies!

### **What is a diurnal fuel system?**

Your new vessel is equipped with an Environmental Protection Agency (EPA) compliant diurnal fuel system, designed to reduce fuel emissions to atmosphere using criteria mandated by the EPA. Your vessel's fuel tank is required and designed to have a positive pressure (>1PSI) as the sun heats the boat and the fuel in the tank expands or it may be equipped with a carbon canister to catch and contain fuel vapors.

Your boat's fuel tank also has valves installed inside that are designed to:

1. Produce a clean refueling shut off event.
2. Create a 5% vapor space.
3. Reduce the propensity of a refueling spit-back event.
4. Allow for appropriate venting when the vessel is stored or trailered. Your fuel cap also contains valves designed to retain fuel vapor (up to 1PSIG) and to allow make up air during engine operation.

**SPORTSMAN**

# Fuel System

## Diurnal Fuel System (cont'd)

### Vapor Space (Ullage) And Refueling Management

Another fuel system necessity to remain EPA compliant it is to keep elevated temperature gasoline from expanding into fuel system areas that are not low permeation rated or otherwise sensitive to raw fuel. A vapor (or ullage) space must be produced at the completion of the filling or refueling operation to ensure systems remain EPA compliant during the diurnal temperature cycle. To effectively manage this system function, BluSkies has created a series of valves that can mount to any marine fuel tank to achieve the appropriate fill level while maintaining ullage space of ~5%. Additionally these valves eliminate the propensity for refueling "spit-back" or tank "well-back", which is another requirement of the EPA regulation.

BluSkies primary ullage valves replace the existing fill and vent locations, while additional grade or tip level valves can be added to any tank to meet American Boat And Yacht Council standards (H-24) which allows vapor venting for boats stanting or sloping when stored, moored, parked or trailered.

The final decision on which system type and ullage valve type and placement that is best for your application should be based on application specific factors such as type and configuration of fuel tank, how much room there on board is for added components, how are the boats likely to be used and stored etc. and of course cost.

Choose individual components to create a compliant system from the following pages or you can turn to our specialists for sound guidance and direction as you go through the process to choosing the appropriate system for your particular vessel application.

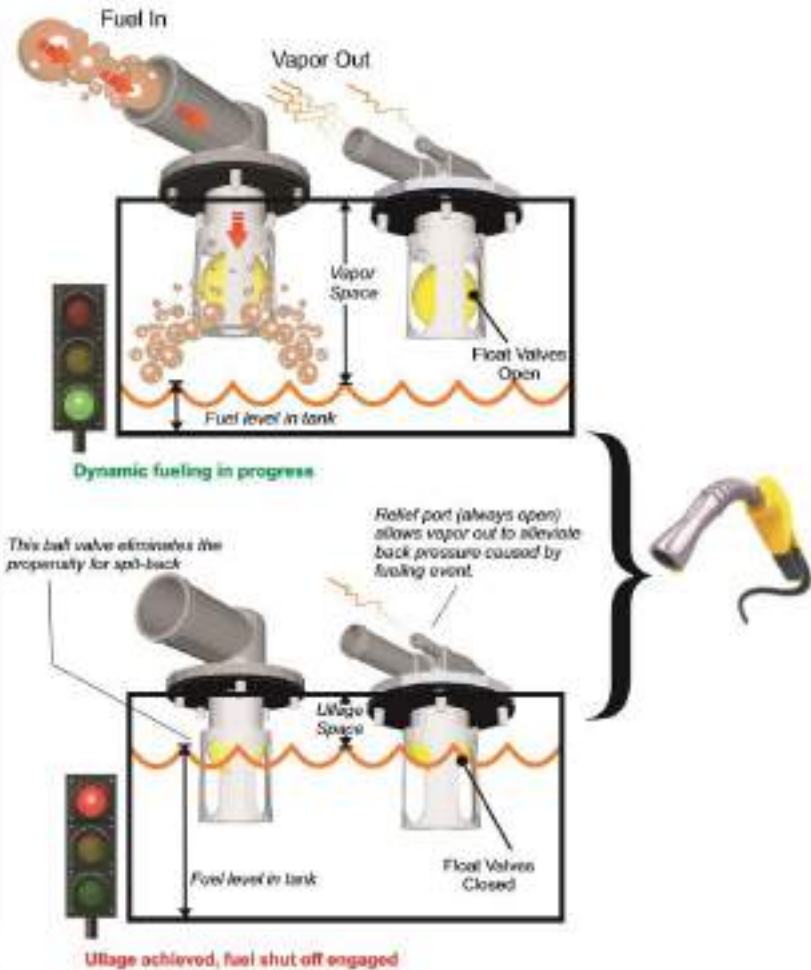

# Fuel System

## Tank Vapor Space & Fluid Management



### Ullage (Vapor Space) Level Attainment Spit-back/Well-back Control

This vent valve shuts off the refueling vapors and creates back pressure to lift the fill valve ball into place.

This fill valve ball is set lower than the vent valve ball but does not close until the refueling vapors are shut off by the vent valve.

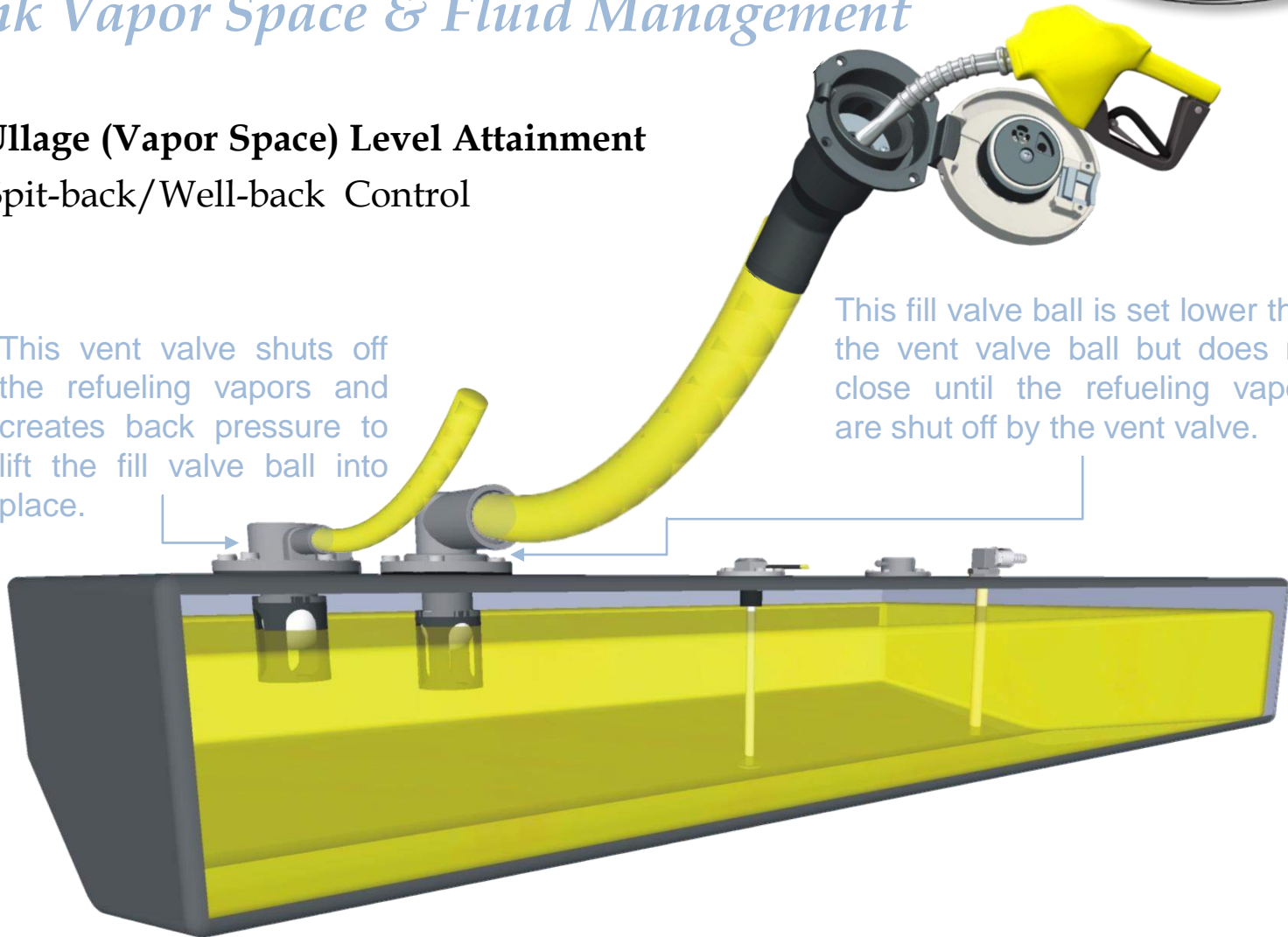

**SPORTSMAN**

# Fuel System

## Diurnal Fuel System: Refueling



Your fuel tank capacity will vary from the label or published capacity no less than 5% by law and up to 10% dependent upon the variation from static float due to equipment, occupants and gear etc. (Static Float = attitude in which your boat floats in calm water)

**Fill your vessel fuel tank as normal, stop refueling after two (shut off) clicks of the fuel nozzle.**

Topping off will over ride your fuel system design intent and could cause damage to your vessel due to overflow and will void any and all warranty claims related to fuel spillage.

BluSkies is expressly not responsible for any damage to your vessel subsequent to topping off.

### WARNING

CONTENTS CAN BE UNDER PRESSURE  
AVOID SERIOUS INJURY OR DEATH FROM  
FIRE OR EXPLOSION  
OPEN SLOWLY IN WELL VENTILATED AREA  
NO SMOKING OR OPEN FLAMES

It has been a common practice for many years to top off boats prior to storage or in preparation for a day on the water, however diurnal fuel systems are designed specifically to leave a space in your fuel tank to allow the fuel to expand during the heat of the day. GASOLINE EXPANDS 5%.

### REFUELING

GASOLINE CONTENTS UNDER PRESSURE. FUEL SPRAY MAY OCCUR.

1. OPEN CAP SLOWLY
2. INSERT FUEL NOZZLE
3. BEGIN & CONTINUE FUELING UNTIL FUEL NOZZLE KICKS OFF
4. WAIT 10 SECONDS & CONTINUE FUELING UNTIL NOZZLE KICKS OFF A SECOND TIME
5. RETURN NOZZLE TO PUMP
6. DO NOT TOP OFF



# Boating Navigation Rules

There are three main situations that you may encounter with other vessels which could lead to a collision unless the Steering Rules are followed:

- Meeting:** you are approaching another vessel head-on
- Crossing:** you are travelling across the path of another vessel
- Overtaking:** you are passing or being passed by another vessel

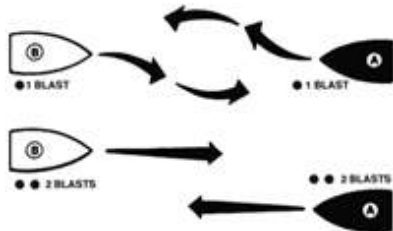

**When Meeting Port-to-port:** Continue on course. The same holds true for meeting starboard-to-starboard.

**When Meeting Head On:** As in a car, both stay to your right and as far apart as practical. Each boat should turn to starboard and pass port-to-port.

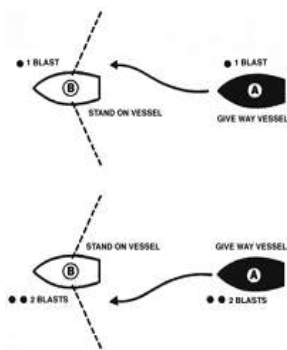

**When Crossing:** Every boat has a "Danger Zone" from straight in front (the bow) to past the middle of its right side. Like when meeting another car at a street intersection, the one on the right has the right of way. You must yield to boats in your Danger Zone. If you are the skipper of the Vessel A in the center of the diagram, you must keep out of the way of any boat that approaches you from any direction within the indicated Danger Zone, as you are the burdened craft. Likewise, boats approaching you from all other directions, except the meeting vessel, must keep clear of you.

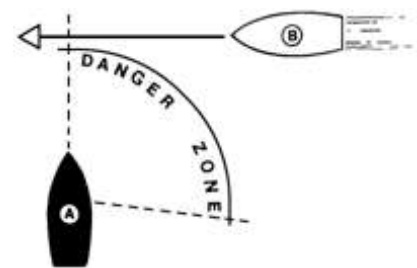

**When Overtaking Another Boat:** The boat being overtaken is the privileged vessel. Only after signaling and receiving an acknowledgment can the overtaking boat pass. (Use one blast to pass on the right, and two blasts to pass on the left.)

**When Being Overtaken:** Be ready for trouble when a power boat passes you in a narrow waterway. As the lead boat, which always has the right of way, stay on your side of the channel and maintain a steady speed so that the overtaking vessel can pass you safely. Use your radio to discuss this with the passing boat.



# Warranty and Services

## *Product Changes*

Sportsman is committed the development of our product line. As a result, equipment described in this manual may have changed or no longer may be available. All information, illustrations and specifications contained in this manual reflect the latest product information available at the time of publication. Sportsman reserves the right to make changes to its boats at any time, without notice. These changes include, but are not limited to: color options, materials, standard and optional equipment, specifications and model availability. If you have any questions about the equipment on your boat, please feel free to contact Sportsman.

## *Insurance*

In most states, the boat owner is legally responsible for damages or injuries they or anyone else operating the boat causes. Some states have laws that require having at least minimum coverage. Before using your boat for the first time, you should contact your dealer, current insurance company, or state boating authority for information regarding insurance requirements in your area. Although it may not be required in your area, responsible boat owners carry liability and property damage for their boat. You should also protect the boat against physical damage and theft.

## *Service*

All warranty work must be performed by an authorized Sportsman Dealer. If a problem is discovered upon taking delivery of, or develops during routine use of the boat that is related to faulty workmanship and/or materials, as stated in the warranty, you need to contact your Sportsman dealer to arrange for your boat to be repaired. **The boat owner is responsible for delivering the boat to the dealer for warranty service.** If you are not near your dealer or any other authorized Sportsman dealer, please contact Sportsman. Likewise, if the dealer fails to repair the problem, please notify Sportsman within 14 days of the work being completed. **Sportsman will not reimburse owners for unauthorized warranty work.**

# SPORTSMAN



# Warranty and Services

## SPORTSMAN BOATS LIMITED WARRANTY

**Ten-Year Hull Limited Warranty:** This limited Warranty applies to any Structural Hull Defect (as that term is defined below) if such is due to a failure in material or workmanship and the was reported to Sportsman according to the terms of this Limited Warranty within ten (10) years from the date of the sale to the original purchaser of the Sportsman authorized dealer. Sportsman, in its sole discretion, will either repair or replace the Hull. For purposes of this Limited Warranty, the term "Hull" shall mean the single fiberglass molded shell and integral structural components of a Sportsman Boat, and the term "Structural Hull Defect" shall mean a substantial defect in the Sports Boat's Hull that causes the boat to be unfit or unsafe for general use as a pleasure craft under normal operating conditions.

**One Year Nonstructural Limited Warranty:** This Limited Warranty applies to any Nonstructural Defect (as that term is defined below) if such is due to a failure in material or workmanship and the same was reported to Sportsman according to the terms of this Limited Warranty within one (1) year from the date of the sale to the original purchaser of the Sportsman Boat by a Sportsman authorized dealer. Sportsman, in its sole discretion, will either repair or replace the defective component. For purpose of this Limited Warranty, the term "Nonstructural Defect" shall mean a substantial defect in a Sportsman Boat's components manufactured or installed by Sportsman (other than the Hull) that is not excluded in the exclusions below.

**Registration and Transfer of Limited Warranty:** Each original purchaser of a Sportsman Boat shall complete and return the boat registration card provided by Sportsman within thirty (30) days of such owner's purchase of the boat in order to facilitate the processing of warranty claims and for manufacture notification. Except where a Sportsman Boats has been salvaged and resold after a declaration of a total loss or a total loss or a constructive total loss, this Limited Warranty is transferrable to a subsequent owner of the Sportsman Boat. PROVIDED SUCH SUBSEQUENT OWNER FILL OUT AND SEND TO SPORTSMAN A SPORTSMAN WARRANTY TRANSFER FORM (AVAILABLE FROM SPORTSMAN ON REQUEST). A COPY OF THE BILL OF SALE, WHITHIN THIRTY (30) DAYS OF SUCH TRANSFER OR PURCHASE.

# SPORTSMAN



# Warranty and Services

## **SPORTSMAN BOATS LIMITED WARRANTY (cont'd)**

### **EXCLUSIONS:**

This limited Warranty does not apply to any boat that has been salvaged or declared a total loss or constructive total loss for any reason not specifically covered in this Limited Warranty. In addition, this Limited Warranty does not apply to the following "Exclusions:"

- 1) A Hull, component, or other product that has been repaired without authorization of Sportsman or that has been altered in any way that affects its use and operation;
- 2) Expenses related to inspection or warranty service for hauling out, transportation to and from any dealer or Sportsman factory, towing or storage changes, inconvenience or loss of time or income;
- 3) Engines, outdrives, controls, propellers, engine brackets, stereos, depth finder, GPS units, trolling motors, batteries, outriggers bases' and other equipment or accessories that are not manufactured by Sportsman, whether the same is or is not warranted by such other manufacturer;
- 4) Blistering, discoloring, cracking, or crazing of the Gelcoat finish or other surface finishes
- 5) Any Sportsman Boat initially sold at retail by a party other than an authorized Sportsman dealer;
- 6) Damage to, breakage of, or leakage around any windshields, hatches, or apertures;
- 7) Any canvas, zippers, vinyl, upholstery, plastic, or fabric components;
- 8) Discoloration, oxidation, bleeding, or corrosion of any stainless steel or other metal products
- 9) Any Hull, component, or product that has been subject to unreasonable use, tampering, abuse, mishandling, improper maintenance, negligence, improper trailing, alterations, or accidents;
- 10) Any boat, or component or part thereof, that has been used for Commercial Purpose, racing purposes, or has otherwise been operated contrary to any printed instruction provided by Sportsman or contrary to any applicable law (for purposes of this Limited Warranty, the term "**Commercial Purposes**" shall mean the usage of any boat more than fifty percent (50%) for revenue-producing or other business purposes);
- 11) A boat, or component or part thereof, that has been overpowered according to the maximum recommended engine horsepower specified on the capacity plate attached to the boat;
- 12) Machinery, equipment and accessories not installed by Sportsman;
- 13) Condensation of gauges;
- 14) The failure of any part, area, or component of the boat to be dry, whether or not the same was represented as "dry";
- 15) Any representation relating to the speed or weight of any part or component of the boat;
- 16) Normal wear and tear maintenance items, including, but not limited to, filters bulbs, batteries, bungees, anchor rope, trailer finishes, tires, brakes, bearing, and lights;
- 17) Any defect or repair requiring redesign of the boat, except pursuant to the recall provisions of the United States Federal Boat Safety Act of 1971 or the recall laws of the recall laws of any other foreign jurisdiction;
- 18) Dealer preparation, cleaning, and final adjustments and alignments in preparing the boat for delivery or commissioning; or
- 19) Any act of God or force majeure.

# SPORTSMAN

<https://www.boat-manuals.com/>



Thank you for your purchase of your Sportsman Boat.

Sportsman Boats Manufacturing, Inc.  
113 Isaac Way · Summerville, South Carolina 29483  
Telephone (843) 376-2628 · Fax (843) 376-2636

Email  
*sales@sportsmanboatsmfg.com*

Website  
*www.sportsmanboatsmfg.com*

P.O. Box 2100  
Summerville, SC 29484



***SPORTSMAN***