



WELCOME

Dear New Cobia Owner,

On behalf of Cobia Boats, I would like to congratulate you on your purchase. We at Cobia strive to build the best products possible and wish you years of trouble free enjoyment. There are many things to know about the operation, care and maintenance of our products and the systems we install in them. Please review all the applicable information for your new boat. The more you know, the more you will enjoy your new Cobia.

Again, a heartfelt Thank You from myself and the whole Cobia Family.

Scott Deal, President and CEO



TABLE OF

Yamaha Engine Break-In Periods.....	3	Optional Bow Cushion Set.....	17
Engine Stop Switch.....	3	Dual Battery System.....	15
Fuel / Water Separators.....	4	Optional Salt Water Washdown.....	20
Garboard Drain Plug.....	4	Optional Fresh Water Shower.....	18
Instrument Panel with Yamaha Multi-Function Gauges.....	5	Optional Trim Tabs.....	19
Switch Panels.....	5	Optional Command Link Gauges.....	18
Switch Panels & Helm.....	5	Warranty.....	24
217 Boat Layout.....	6		
Cobia Duffel Bag.....	6		
Bilge System.....	7		
Ball Valves, Thru Hull Fittings, & Scuppers.....	8		
Stainless Boarding Ladder.....	10		
Cockpit Courtesy Lights.....	9		
Props.....	10		
Head & Waste System.....	19		
Fuel System.....	11		
Self Bailing Cockpit.....	12		
Livewell System.....	12		
Rod Lockers.....	13		
Forward Storage.....	14		
Anchor Locker / Rode Storage.....	14		
217 Aluminum Plate Location.....	14		
Specifications.....	2		
Wiring Color Codes.....	16		
Optional Cockpit Bolsters.....	18		

217 SPECIFICATIONS

L.O.A.....	21' 7"
BEAM.....	8' 6"
DRAFT.....	14"
WEIGHT W/O ENGINE.....	2950
LBS.	
FUEL CAPACITY.....	100 GAL.
DEADRISE @ TRANSOM.....	20
DEG MAXIMUM	
H.P.....	200
TRANSOM HEIGHT.....	25"
MAXIMUM CAPACITIES.....	8
PERSONS OR 1600 LBS	

ENGINE BREAK-IN

Engine Break-In Period

New engines require a period of break-in to allow the surfaces of the moving parts to mate evenly. Different engines require different break-in periods and methods. For instructions on break in methods, refer to your Yamaha Engine Owner's Manual for the correct break-in procedures and times for your model engines

Engine Stop Switch

If activated, the spring loaded engine stop switch will automatically shut down the engine during emergency situations to prevent uncontrolled or unattended operation. Certain emergency conditions (e.g., turbulent water, wakes, accidental shove) may impair a person's ability to operate the craft safely. The switch, located on the helm, must have the safety lanyard attached at its base. This activates the protective shutdown circuitry.

Securely attach the other end of the lanyard to the operator of the boat. If the operator moves, falls or is at an unsafe distance from the steering wheel, tension on the lanyard will pull it from the switch. When the lanyard is removed, the engine stop switch is released and automatic engine shutdown occurs.



Engine stop switch (above)

Engine Stop Switch

⚠ DANGER

An engine stop switch system that is not used or does not function properly can cause death or serious injury. **DO NOT** operate the boat if the engine stop switch system does not function properly. Go to a Cobia Dealer to have this resolved immediately

The lanyard should be securely attached to the boat operator at all times that the engine is on.

FUEL-WATER

Fuel-Water Separator

A Yamaha Fuel - Water Separator is installed between the fuel tank and engine on your 217 model. The new, improved 10-micron filter provides superior filtration ahead of the engine's on-board filters and injectors. Large filtering and water capture areas maximize filtration while maintaining adequate flow rate for larger engines. The fuel separator can be checked by removing it from the mounting bracket and dumping it into an approved waste collection device. If there appears to be an excessive amount of water, the filter component should be replaced. See your authorized Cobia Dealer for replacement parts.



Maintenance Note

Yamaha recommends replacing the 10- micron fuel filter on new boats after the first 10 hours or 1 month of operation and every 50 hours or every 6 months thereafter. In areas of high humidity where water in fuel supplies is a problem or extensive engine operation occurs, more frequent replacement may be necessary.

Garboard Drain Plug

The garboard drain plug is the small metal plug located at the lowest point on the hull, at the bottom of the transom right above the keel. The drain has been designed so that it can be loosened by hand while the hull is out of the water for draining. This allows the plug to stay in contact with the surrounding frame so you'll never misplace or lose it. You can completely remove the insert by pulling back and continue turning in a counter clockwise motion. It is manufactured with a rubber seal in place to ensure you bilge is watertight. Always make sure before putting the boat in the water that this plug is hand tightened firmly. Excess water in the bilge may be an indication of a problem with this plug or the automatic bilge pump. Refer to page 7 of this Owner's Manual for information on your boats bilge system.



SWITCH AND

Switch Panel & Helm

At the helm of the 217 CC, you have a main switch panel, which is located to the left of the steering wheel. This panel controls your lights, horn, accessories, livewell, and your bilge. When a switch is in the "on" position, its tip is illuminated. This alerts you that the associated accessory should be functioning and also reminds you to turn it off during boat shutdown. When the "NAV" light switch is in the "on" position, the labels for the switches will be illuminated. To the right of the steering wheel you may have your two trim tab switches, which are optional on the 217. (Refer to page 23 for trim tab operation.) The 217 also comes standard with a compass mounted on top of the console.



Switch Panel

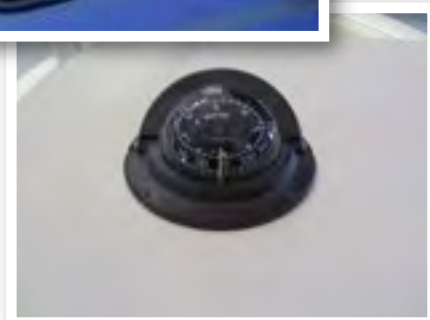

Compass

Instrument Panel

The instrument panel on your 217 CC is composed of two Yamaha Multifunction Digital Gauges. The standard digital gauges include a tachometer. The tachometer has several built in features including an oil level monitor, an engine temperature monitor and engine trim indicator. Yamaha speedometer includes a digital readout of the speed, an hour meter, trip meter, and clock.



BOAT LAYOUT

217 Boat Layout

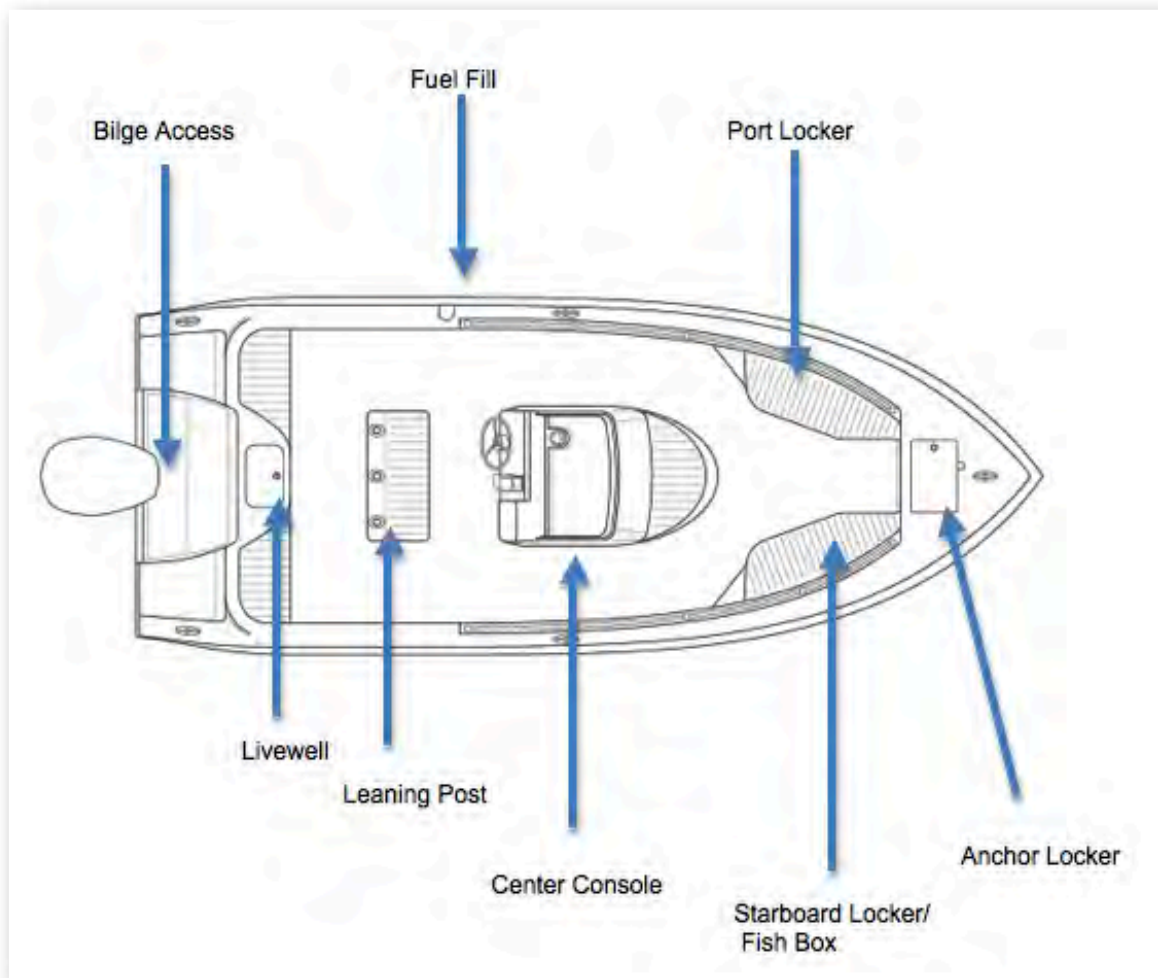

Cobia 217 Duffel Bag

Cobia Duffel Bag

Along with your boat, you received a Black Duffel Bag with your new Cobia 217 CC. Inside the Duffel Bag are the following items:

- Large Livewell Standpipe
- Short Livewell Standpipe
- 1.5" Livewell Pacifier Plug
- 2 ignition Keys and Emergency Kill Cord /Engine Stop Lanyard
- Yamaha Engine Owner's Manuals
- Engine Start Cord
- Various Appliance and Accessories Manuals

BILGE

Bilge

The bilge of the Cobia 217 should always be checked before and after a launch. While checking the bilge, note that a small amount of water in the bilge is normal.

However, a large amount of water or any signs of fuel or oil requires immediate attention. **If such a situation exists, the boat should be taken to a certified marine technician immediately. Never pump fuel or oil overboard while your boat is in the water.**

Large quantities of water in the bilge may be an indication of a leak or that the bilge pump and/or automatic float switch is not functioning properly due to a jam, clog or electrical issue. The automatic float switch is wired to the hot side of the battery switch through the "BILGE" fuse at the battery switch panel. When functioning properly, the float switch activates the bilge pump to pump water overboard once water in the bilge reaches a level that submerges the switch.

If your bilge pump does not come on when the float switch is submerged, attempt to manually turn on the bilge pump on your switch panel. If the bilge pump comes on and evacuates the water, it is clear that the float switch is not functioning properly. If the bilge pump does not come on via the switch panel, check the breaker panel inside the console to see if a breaker has been tripped. If the breaker has been tripped, reset it, and turn the switch on again, listening for the bilge pump to turn on.

If the bilge pump fails to turn on, turn the battery switch to the OFF position, then unhook the bilge pump from its cradle by pressing down on the blue tabs on the cradle and gently turning the top of the pump. You will feel the pump release from the cradle. The entire bilge pump and wiring should release from the cradle. After removing the pump, check the underside and impeller areas for miscellaneous items that might clog the pump. If any obstructions are present remove the debris and set the pump back into the cradle. Once set back in the cradle, press the blue tab down and rotate the pump until you feel it snap back in place. Once this is completed you can try to turn the pump on again.

If the bilge pump still does not turn on, it likely needs to be replaced. It is not recommended to use your boat if the bilge pump and/or float switch are not functioning properly.



Bilge Pump

Automatic Float Switch

SYSTEMS

Ball Valves

Ball valves can be used to serve several purposes. They allow seawater to enter the boat, in the case of livewells, and they also act as a safeguard to stop water from entering. To tell which position a ball valve is in, open or closed, look at the valve and determine the direction of flow. When the ball valve handle is in the same position as the direction of flow, the valve is in the "OPEN" position. When the ball valve handle appears to cross the direction of flow, the valve is in the "CLOSED" position.

217 Deckdrain System

The deckdrain system is equipped with 1 1/2" thru hull fittings through the aft port and starboard hull sides. These fittings have to be installed lower than the drains in the cockpit floor so that gravity will allow the cockpit to drain free of water. This puts these fittings very close to the water line of the hull. These drains are rigged with ball valves that can be opened and closed to control the flow of water. In the open position, these ball valves will allow water to flow freely from the cockpit, thus making the boat "self-bailing". When closed, no water will be allowed to travel to or from the cockpit.

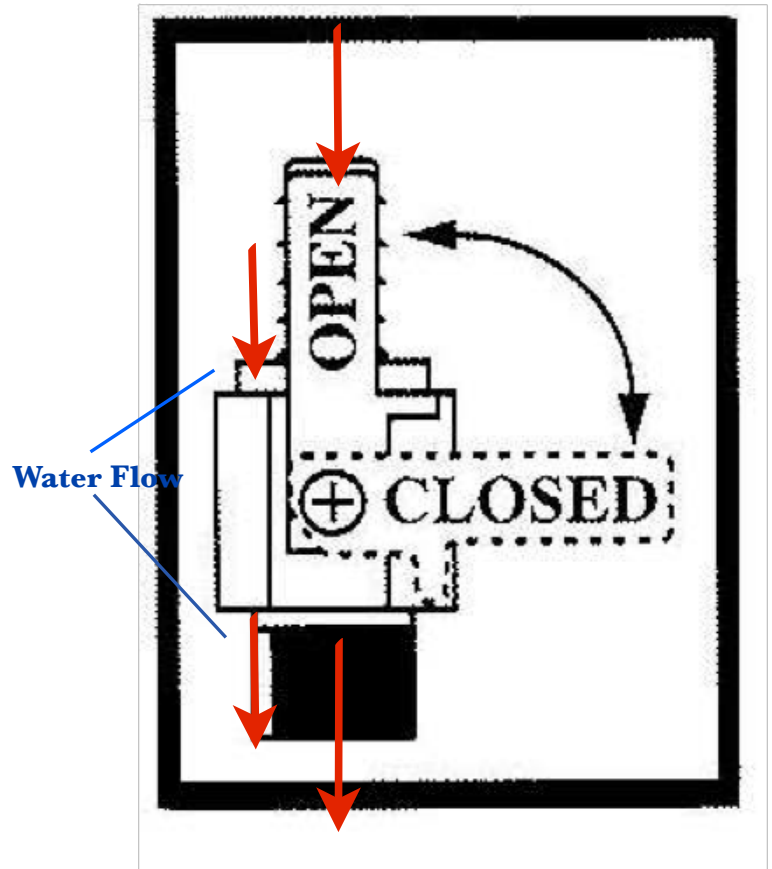

217 Livewell Pump Assembly

The livewell pump assembly is composed of a scoop strainer mounted to the bottom of the hull, a thru hull fitting, ball valve assembly, and the pump. As you can see, the ball valve assembly is in the "OPEN" position. This is the correct position for the operation of the livewell system.

*THE LIVEWELL PUMP
ASSEMBLY IN THE "OPEN
POSITION*



COCKPIT COURTESY

Cockpit Courtesy Lights

The cockpit comes equipped with five L.E.D. courtesy lights installed at the factory. On the switch panel located to the left of the steering helm, the second switch to the right operates the cockpit courtesy lights. The courtesy lights are mounted on the port and starboard sides of the console, as well as at the front of the cockpit. These lights illuminate the entire cockpit.

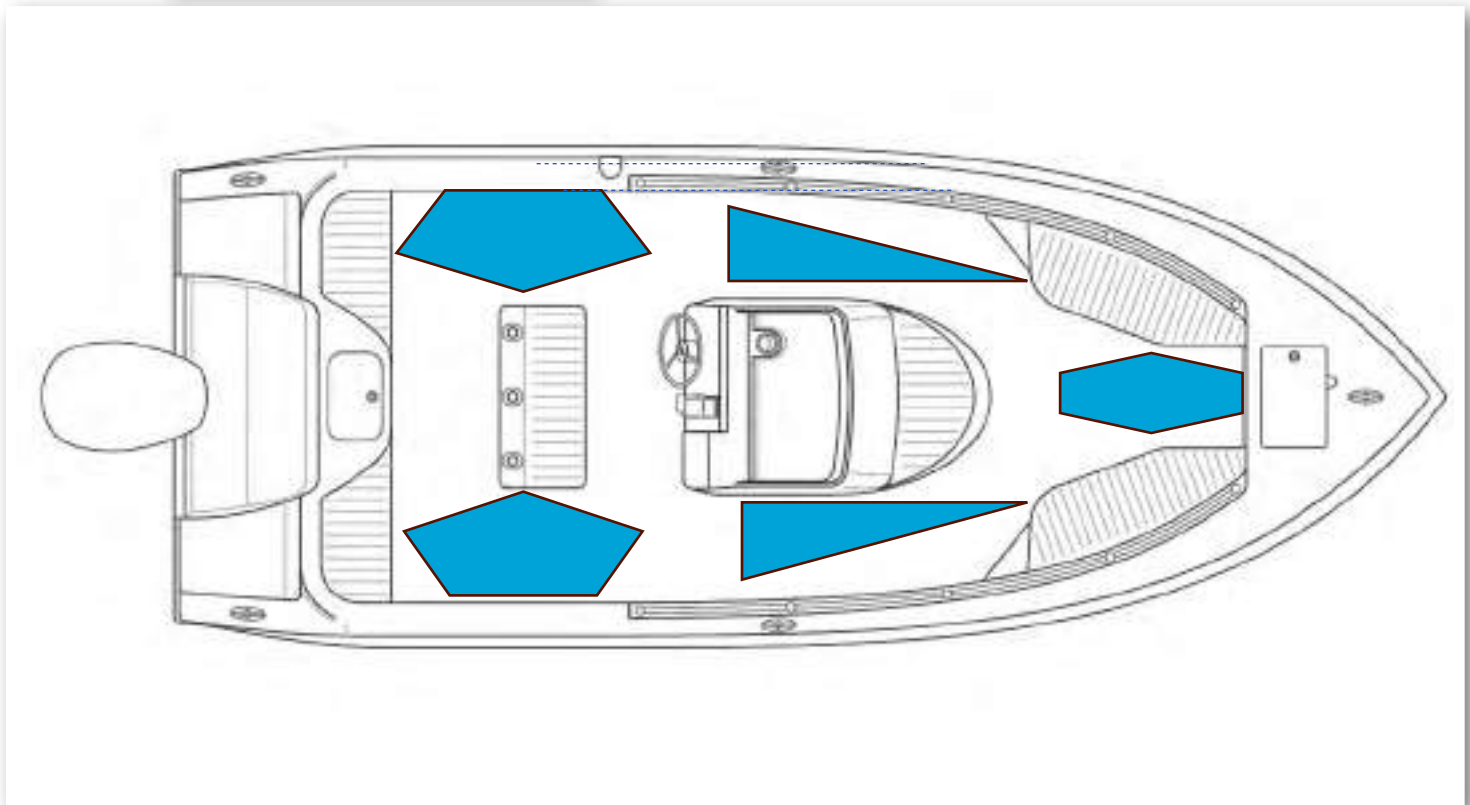
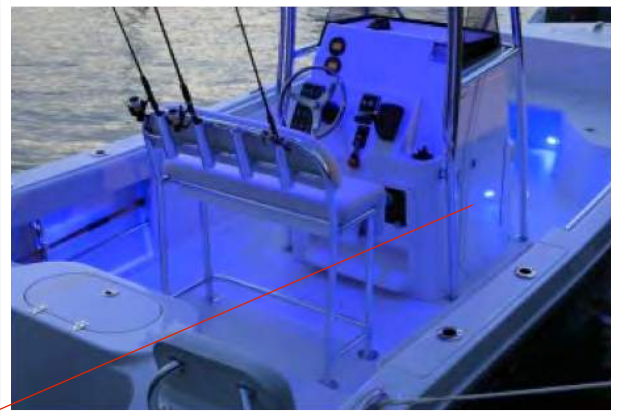

Diagram of the LED Cockpit Courtesy Lights

LADDER AND

Stainless Boarding Ladder

The 217 model comes standard with a telescoping stainless steel boarding ladder integrated into the port aft platform area. This provides a stepping area while the ladder is in the up position as shown below.



⚠ DANGER

No passenger should attempt to enter or exit the boat by the ladder or by any other means while the engine is on.

Props

Prop selection on your Cobia is determined by your local Cobia Dealer, but all props are based on recommendations from Cobia Boat Company and Yamaha Marine in order to give your boat maximum overall performance. The needs of your prop will determine the prop design and size that best fits your performance requirements.

Always inspect the engine and prop prior to launching your boat with the engine off. Key prop issues include tangled fishing line or other types of debris, cracked blades or fluid leaking out of the seal. Look for fishing line tangled around the prop or lower unit seal. **Consult your Yamaha's Owner's Manual to address these issues.**



FUEL SYSTEM

FUEL SYSTEM

The Cobia 217 CC comes equipped with a 100-gallon fuel cell stationed below the leaning post between the stringer system. The fuel fill receptacle is on the port gunnel. Every fuel tank is pressure tested at the factory before and after installation. Should you experience any fuel related problems or suspect problems with the fuel system, immediately take your boat to a Cobia Dealer.



CAUTION—Do not smoke while filling the tank. Be sure to turn off the engines and all electrical equipment when fueling the boat to prevent accidental discharges of static electricity. Use only the recommended gasoline (see Yamaha's Owner's Manual). Do not use fuels with alcohol or alcohol related derivatives that can cause marine fuel system hoses to deteriorate.

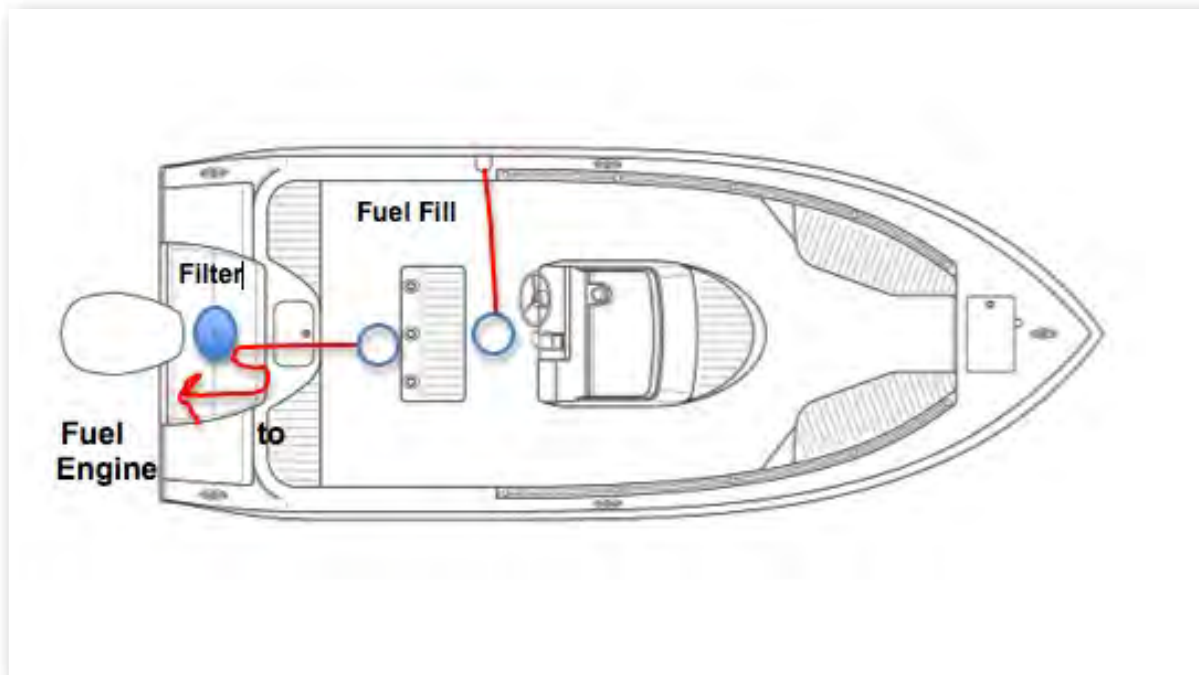

FUEL SYSTEM DIAGRAM

SELF-BAILING COCKPIT & LIVEWELL

Self Bailing Cockpit

The cockpit on the Cobia 217 is designed to be self-bailing, meaning that all the water that comes into the cockpit will be directly drained overboard. This keeps the boat from acquiring standing water and allows the boat to drain at all times, including while the boat is docked.

Water drains out of the cockpit through two aft cockpit drains located at the far aft cockpit floor on both the port and starboard sides. Each side drains overboard through the side of the hull independently. None of this water is drained into the bilge. Refer to page 8 for operation of the ball valve associated with this system.

The bilge is designed to drain any water entering the inside of the hull. All hoses are sealed and double clamped during construction. Continuous or periodic running of the automatic bilge pump may be an indication of a hose leak or break in a seal, and should be investigated by a Cobia Dealer immediately. Refer to page 9 for further information regarding bilge pump operation and maintenance.



Livewell System

The livewell system on the 217 is designed to keep your baitfish alive and strong for as long as possible. This livewell provides a cool, clean, and oxygenated environment that allows you to keep your baitfish alive for long periods of time.

To efficiently operate your livewell, the following steps should

1. **Open livewell hatch.**
2. **Install stand-up pipe snugly.**
3. **Ensure livewell pump ball valve is in open position.**
4. **Turn on livewell switch.**

The livewell operates by pumping fresh seawater from the pump through an aerator head into the livewell. Drainage is achieved through the grate on the top of the standpipe, which, when unobstructed, will limit the water level to the standpipe's highest point. A shorter standpipe can be used to keep less water in the well. This constant drainage keeps up water flow and allows for the removal of ammonia from the livewell, therefore extending the life of your baitfish. To drain the livewell, switch off the pump, close pump ball valve, and remove standpipe.



ROD LOCKERS & FISH

Rod Lockers

The 217 center console model comes standard with under gunnel rod racks on both the port and starboard sides. These give you space to safely store an additional 6 rods for your fishing needs. These lockers can also double as storage for various other items (as seen below).



Starboard Gunnel Storage Rack

Port and Starboard Fish Lockers

The 217 CC has port and starboard storage compartments in the bow. The starboard locker doubles as a fish locker and is insulated to keep its contents cold (as seen below). These boxes drain overboard through independent thru hulls on each side of the hull just below the boxes.



ANCHOR LOCKER/PHENOLIC

Anchor Locker/Rode Storage

The anchor locker is located at the bow of the boat and is accessible through the anchor locker door or hatch (photo below). There is an eye mounted to the bow eye to secure your anchor rode or chain to. After setting your anchor, the excess rode can remain stored in the locker. The notch supplied in the door allows you to securely close the locker by aligning your rode through the notch.

Rode Storage



Phenolic Plate Location

Your Cobia 217 comes standard with phenolic plates laminated into the cockpit floor. These plates secure the leaning post and optional T-top and are designed for exceptional screw retention capabilities and provide the support required to secure such weight bearing items.

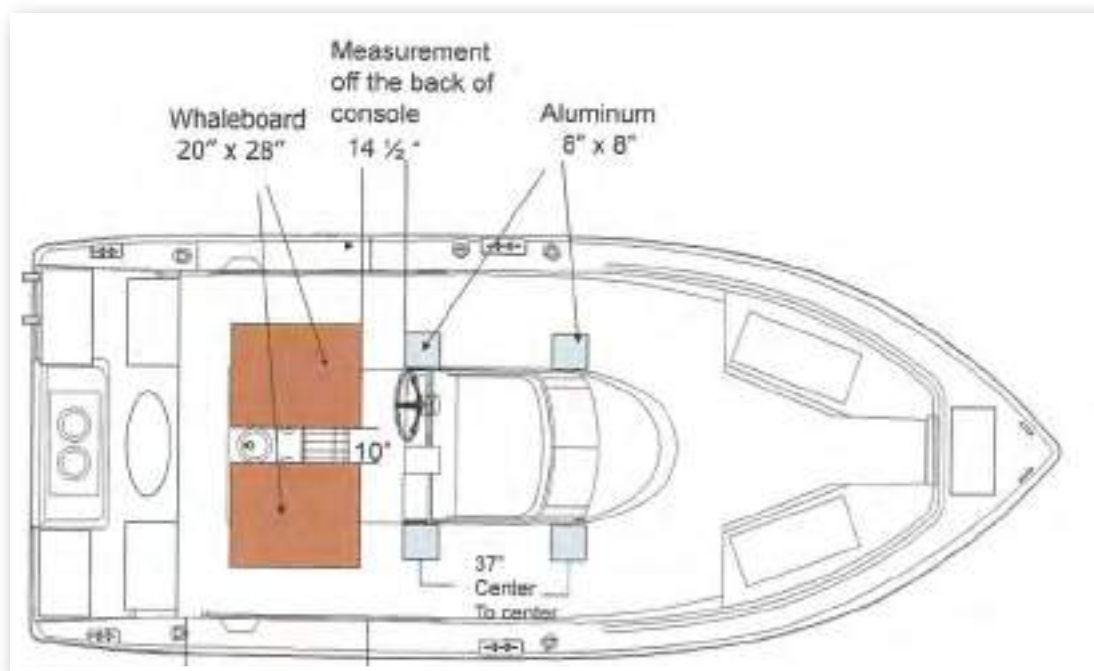

BATTERY SWITCH

Battery Switch

Whether equipped with single or dual battery setup, the batteries are located behind the battery access door along the starboard aft cockpit wall. The switch panel is located at the aft starboard cockpit. On a single battery system, your battery is wired to the number 1 side of the switch. On the optional dual battery setup, one battery is wired to the number one position while the second battery is wired to the number 2 side of the switch. The operator can choose which battery to utilize by the selection on the switch. The only time the switch should be in the “1 & 2” position is if one battery will not start the engine. Then, switch to “1 & 2” and have two batteries start the engine.



Battery Switch, Shown in the “Off” Position

Cobia Boat Wiring Color Code			Horn	Orange / White		
Pumps:	Livewell Pumps		Wire Color			
	Livewell -- 1	Brown / White				
	Livewell -- 2	Brown / Yellow	Main Wires	Wire Color		
	Livewell -- 3	Brown / Orange	Positive	Red		
	Recirc. Pumps		Wire Color	Ground Wires	Wire Color	
	Recirc. Pump -- 1	Red / White		Lights	Black	
	Recirc. Pump -- 2	Red / Yellow		Pumps	Black	
	Recirc. Pump -- 3	Red / Orange		Main	Black	
	Bilge Pump		Wire Color	Trim Tab Wires	Trim Tab Wires	Wire Color
	Aft Bilge pump	Brown		Stbd. (white)	Red	
	Brown / Red		Stbd. (black)	Blue		
Water Pumps		Wire Color	Port (White)	Green		
Freshwater Pump	Brown / Black		Port (Black)	Yellow		
Saltwater Pump	Brown / Green	Jack Plate Wires	Jack Plate Wires	Wire Color		
Lights:	Navigation Lights		Wire Color	Red (Hot wire)	Red	
	Nav. Light	Grey		Blue (Up)	Blue	
	Anchor Light	Grey / White		Green (down)	Green	
	Courtesy Lights		Wire Color	Acc. Wiring	Wire Color	
	Panel Lights	Blue		Tower Anchor Light	Grey/black (2)	
	Console Lights	Blue / Red		T-Top Anchor Light	Grey/black (2)	
	Rod Locker Lights & under Gunnel Lights	Blue / Black		T-Top Spreader Light	Blue/black (2)	
				Speaker Wire	~ ~ ~	
				~ ~ ~	Red / Black (2)	
	Lights:	Livewell Lights		Wire Color	Battery Cables	Wire Color
Livewell -- 1		Blue / White		Red	2 Ga.	
Livewell -- 2		Blue / Yellow		Black	2 Ga.	
				Red	4 Ga.	
				Black	4 Ga.	
Livewell -- 3		Blue / Orange	24 V. T.M. Wires	Wire Color	GA Size	
				Black	6 Ga.	
				Orange	6 Ga.	
Acc. Wires			Wire Color			

OPTIONAL

Optional Features

Many options for the 217 center console model have already been mentioned earlier in the Owner's Manual. The following pages will refer to the remaining options



Optional Bow Cushion Set

On the 217, a four-piece bow cushion set is an available option. These cushion bottoms are removable and are held in place by several sets of stainless steel snaps. To remove the cushions, simply pull the snap strap away from the embedded snap and remove and store the cushion



Port Bow Cushion



Bow Cushion Option



Starboard Bow Cushion

OPTIONAL

Optional Stereo System With CD

A AM-FM Stereo CD with four speakers is offered as an option on the 217 CC. The 217 stereo unit is mounted inside the console on the aft bulkhead. This option comes with a stereo remote mounted on the face of the console, right of the helm, and above the cup holder.



Stereo Unit



Stereo Remote

Command Link Gauges

Command Link gauges are an option for the 217 center console and are an upgrade from the standard digital gauges. Command Link gauges allow access to more information. Displays are user-selectable so you can choose the functions displayed on each gauge and what order. Speed data can be displayed from a pitot tube, Triducer, or NMEA protocol GPS unit



Optional Fresh Water Shower

The fresh water tank on your 217 CC can be filled at the cap labeled "WATER", on the back port corner near the transom. The shower nozzle is on the port aft bulkhead. To pressurize the system, flip the switch labeled "FRESHWATER" on the switch panel at the helm. You can leave this switch in the ON position while the boat is in use. The pump has an internal pressure switch that allows the pump to turn on and off as needed.

In the colder months of the year, it's advisable to drain the fresh water system and winterize by adding a non-toxic antifreeze to the system. Run the antifreeze through the system by opening up the spray in the shower nozzle until antifreeze is delivered through the showerhead.

OPTIONAL

Optional Trim Tabs

Trim Tabs are optional on your 217 Center Console. External electric trim tabs can enhance the performance of your boat. The tabs on the 217 are electric and therefore do not require a trim tab pump. By not having a pump there is no possibility of fluid leaks from a pump.

Trim tabs allow for maximum boat performance, and are great for balancing weight in the boat. They also allow the boat operator to lift or lower the hull to accommodate for different running situations.

For the operation of trim tabs note that the port trim tab switch will affect the port side of the boat, and the starboard switch will affect the starboard side. For instance, lowering the port trim tab creates stern lift on the port side, thus lowering the starboard bow. Raising the starboard trim tab lowers the stern on the starboard side, thus raising the port bow. Use the tabs to adjust the attitude of the boat so that it sits evenly, and to raise or lower the bow to control running performance.

Pushing on the top of the switch (down), will lower the trim tab and force the bow down, which is important when running in heavy seas or a stiff chop. In most cases, both tabs should be lowered for an even bow ride.

Pushing the bottom of the switch (up), will raise the tabs lifting the bow out of the water, for better running performance. To achieve the best running performance of your Cobia 217, use the engine trim in conjunction with your trim tabs to find the appropriate amount of lift for a safe and comfortable ride.

In the event of rough water or high winds, it's possible to use the trim tabs to lift the windward side of the boat to avoid spray blowing back onto the passengers. Do this in conjunction with lowering the bow on the downward side.



Trim Tab

OPTIONAL

Optional Salt Water Washdown

Salt-water washdown is an option on the 217 center console model. The pump is located in the bilge forward of the livewell pump and is accessible through the splashwell hatch or the aft port hatch. To operate, hook a hose to the raw water receptacle in the aft section of the rod locker. Flip the switch labeled "Saltwater". The pump will pressurize the system with raw water. Once the system is pressurized, the pump will shut itself off with an internal pressure switch and will switch itself back on as you demand water. Be careful to only spray gel-coated fiberglass surfaces with saltwater and avoid all other areas. Always rinse your boat with freshwater as soon as you return to the dock or home if the boat is being trailered.



Raw Water Receptacle

Waste System

A portable head unit is an option in the 217. The instruction manual can be found in the Cobia duffel bag and basic operating instructions are listed here.

The optional head pump out fitting is located on the starboard side of the console. With this option, waste can be removed at an approved dumping station without removing the tank from the head.



Porta Potty



Waste Removal Fitting, Top



Portable Toilets Owner's Manual

Manual del propietario Inodoros portátiles

Guide de l'utilisateur Cabinets portatives

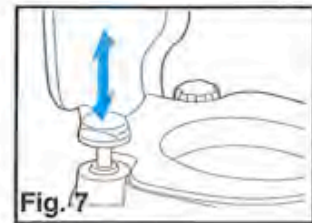
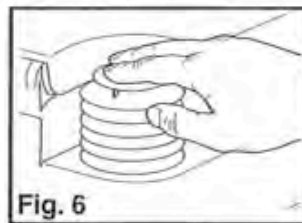
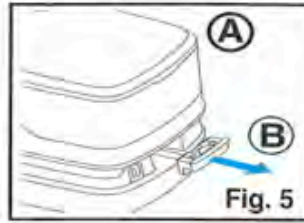
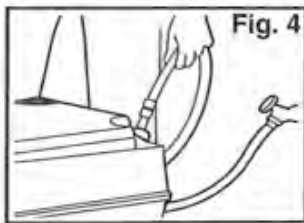
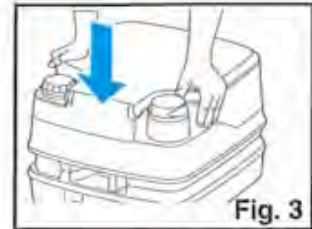
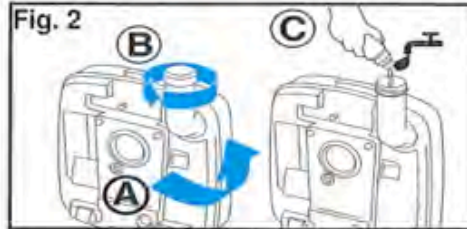
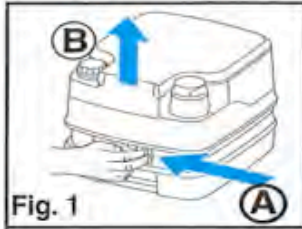

Prepare Unit

1. Separate tanks (Fig. 1A & 1B).
2. Remove Pour-Out Spout Cap while it is pointing upward (Fig. 2A & 2B) add deodorant and 4-oz. of water (Fig. 2C). Replace cap and tighten securely.
3. Recombine tanks (Fig. 3).
4. Fill upper tank with fresh water (Fig. 4). Replace cap and tighten securely.

NEVER add deodorant to fresh water tank.

Before Use

Vent any built-up heat or altitude pressure and prevent splashing: close cover (Fig 5A), and open and close holding tank valve (Fig. 5B).

To Flush

1. Open valve (Fig. 5B).
2. **Bellows:** Fig. 6.
Piston Pump: Fig. 7.
3. Close valve completely for odor-tight seal (Fig. 5B).

Prepare la unidad

1. Separe los tanques (Fig. 1A y 1B).
2. Saque la tapa del caño de vertido manteniéndola orientada hacia arriba (Fig. 2A y 2B), añada desodorante, y 118 ml de agua (Fig. 2C). Vuelva a colocar la tapa y apriétela bien.
3. Vuelva a acoplar los tanques (Fig. 3).
4. Llene el tanque superior con agua fresca (Fig. 4). Vuelva a colocar la tapa y apriétela bien.

NUNCA vierta desodorante en el tanque de agua.

Antes de usarlo

Deje escapar la presión que se haya acumulado debido al calor o a la altura; evite las salpicaduras: Cierre la tapa (Fig. 5A), abra y cierre la válvula del tanque de retención (Fig. 5B).

Para pasar el agua

1. Abra la válvula (Fig. 5B).
2. **Fuelle:** Fig. 6.
Bomba de pistón: Fig. 7.
3. Cierre bien la válvula para evitar los malos olores (Fig. 5B).

Préparer l'unité

1. Séparer les réservoirs (Schémas 1A et 1B).
2. Retirer le capuchon du bec verseur pendant qu'il pointe vers le haut (Schémas 2A et 2B), ajouter le désodorisant et 118 ml d'eau (Schémas 2C). Replacer le capuchon et resserrer hermétiquement.
3. Recombiner les réservoirs (Schéma 3).
4. Remplir le réservoir supérieur d'eau propre (Schéma 4). Replacer le capuchon et resserrer hermétiquement.

Ne JAMAIS ajouter de désodorisant au réservoir d'eau propre.

Avant d'utiliser

Ventiler en cas de pression accumulée ou attribuable à l'altitude et prévenir les éclaboussures : fermer le couvercle (Schéma 5A), ouvrir et fermer la valve du bac à eaux usées (Schéma 5B).

Pour vidanger

1. Ouvrir la valve (Schéma 5B).
2. **Soufflets de dilatation :** Schéma 6.
Pompe à piston : Schéma 7.
3. Fermer la valve complètement pour une étanchéité contre les odeurs (Schéma 5B).

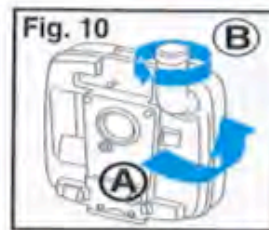
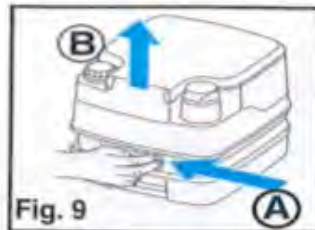
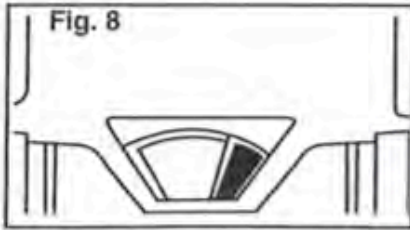

Emptying Waste Tank

1. DO NOT OVERFILL TANK. Empty when waste level indicator turns from **green** to **red** (Fig. 8). (Toilet without an indicator: open valve to check visually.)
2. Be sure valve handle is closed. Separate tanks (Fig. 9).
3. Carry waste tank to a permanent toilet.
4. Remove Pour-Out Spout Cap while it is pointing upward (Fig. 10A & 10B).
5. Press air relief valve to prevent splashing (Fig. 11).
6. Rinse, recharge and reassemble unit.

Para vaciar el tanque séptico

1. NO LO LLENE DEMASIADO. Vacíelo cuando el indicador de nivel cambie de color **verde** a **rojo** (Fig. 8). (Inodoro sin indicador: abra la válvula para examinarla.)
2. Verifique que el asa de la válvula esté cerrada. Separe los tanques (Fig. 9).
3. Lleve el tanque séptico a un inodoro fijo.
4. Saque la tapa del caño de vertido manteniéndola orientada hacia arriba (Fig. 10A & 10B).
5. Oprima la válvula de descarga de aire para evitar las salpicaduras (Fig. 11).
6. Lave, recargue y vuelva a armar la unidad.

Vidange du bac à eaux usées

1. NE PAS TROP REMPLIR LE RÉSERVOIR. Vider lorsque l'indicateur du niveau de déchets passe du vert au rouge (Schéma 8). (Toilette sans indicateur : ouvrir la valve pour une vérification visuelle)
2. S'assurer que la poignée de la valve est fermée. Séparer les réservoirs (Schéma 9).
3. Transporter le bac à eaux usées vers une toilette fixe.
4. Retirer le capuchon du bec verseur pendant qu'il pointe vers le haut (Schéma 10A & 10B).
5. Appuyer sur la soupape de dégagement d'air pour prévenir les éclaboussures (Schéma 11).
6. Rincer, recharger et réassembler l'unité.

Deodorizing

Recommended holding tank deodorant for best performance:

- Thetford Eco-Smart
- Thetford Aqua-Kem
- Thetford Campa-Chem



Para desodorizar Désodorisant

Desodorante recomendado para un mejor funcionamiento del tanque de retención:

- Thetford Eco-Smart
- Thetford Aqua-Kem
- Thetford Campa-Chem

Désodorisant recommandé pour le bac à eaux usées pour une meilleure performance :

- Thetford Eco-Smart
- Thetford Aqua-Kem
- Thetford Campa-Chem

Care

Recommend cleaner:

- Thetford Aqua-Clean.

NEVER use scouring powders, acids or concentrated cleaners, which can damage plastic parts and rubber seals.



Mantenimiento

Producto de limpieza recomendado:

- Thetford Aqua-Clean.

NUNCA use polvos para limpiar, ácidos ni productos de limpieza concentrados, que puedan dañar las piezas plásticas y las juntas herméticas de caucho.

Entretien

Ce nettoyant est recommandé :

- Thetford Aqua-Clean.

Ne JAMAIS utiliser de poudres de récurage, d'acides ou de nettoyeurs concentrés qui peuvent endommager les pièces en plastique et les joints d'étanchéité en caoutchouc .

Service & Parts

For parts and/or service, contact your RV Dealer.

For warranty issues or more information, call Thetford's Customer Relations Department:

1-800-521-3032

Please have ready:

1. Your name and address
2. Toilet Model and Code from ID label.
3. Problem/reason for claim.
4. Proof of date of purchase.

Servicio y repuestos

Para repuestos y servicio, comuníquese con el distribuidor de VR local.

Para asuntos relacionados con la garantía o mayor información, llame al departamento de Relaciones con el cliente de Thetford:

1-800-521-3032

Sírvase tener a mano la siguiente información:

1. Su nombre y dirección
2. El modelo y código del inodoro, de la etiqueta de identificación.
3. El problema/motivo del reclamo.
4. Comprobante de venta

Pièces et main-d'oeuvre

Pour obtenir des pièces ou avoir accès au service, contacter votre distributeur VR.

Pour des problèmes relatifs à la garantie ou pour obtenir de plus amples renseignements, appeler le service à la clientèle de Thetford :

1-800-521-3032

Nous vous recommandons d'avoir à proximité :

1. Vos nom et adresse
2. Le modèle de la toilette et le code de l'étiquette d'identification.
3. Problème/motif de la réclamation.
4. Preuve de la date d'achat

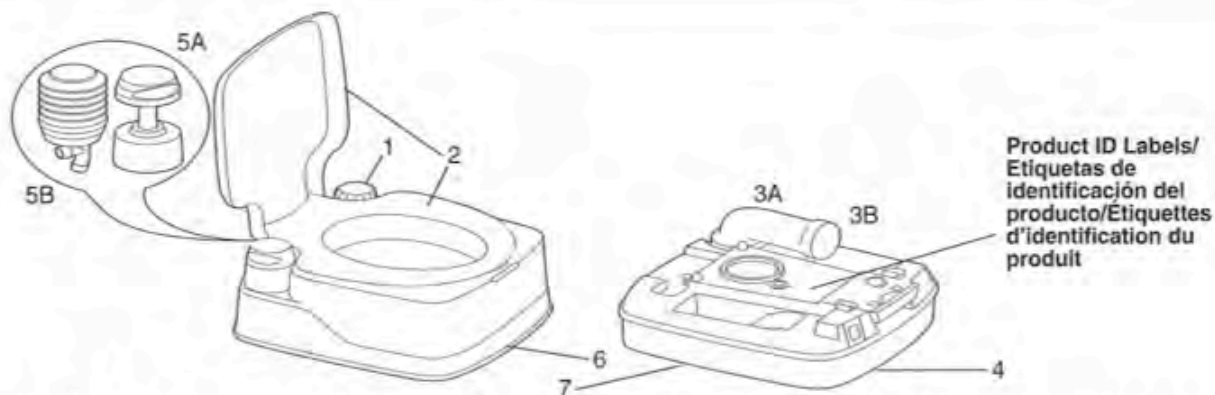

Parts List

All Models

- 1 No-Spill Water Fill Cap
- 2 Seat and Cover Ass'y
- 3A Pour-Out Spout
- 3B Pour-Out Spout Cap
- 4 Hold Down Kit (optional)
- 5A Piston Pump Ass'y
- 5B Bellows Pump Ass'y
- 6 Fresh Water Tank Ass'y, incl. bellows
- 7 Waste Holding Tank w/o Spout

Tous les modèles

Lista de repuestos

Todos los modelos

- 1 Tapa antiderrames de orificio de llenado de agua
- 2 Unidad de asiento y tapa del inodoro
- 3A Caño de vertido
- 3B Tapa del caño de vertido
- 4 Juego de anclas de sujeción (opcional)
- 5A Unidad de bomba de pistón
- 5B Unidad de bomba de fuelle
- 6 Unidad de tanque de agua, incluyendo el fuelle
- 7 Tanque séptico de retención, sin caño de vertido

Liste des pièces

- 1 Capuchon de remplissage pour prévenir le déversement d'eau
- 2 Assemblage du siège et du couvercle
- 3A Bec verseur
- 3B Capuchon du bec verseur
- 4 Trousse de matériel (facultatif)
- 5A Assemblage de pompe à piston
- 5B Assemblage de pompe à soufflet
- 6 Assemblage du réservoir d'eau propre, y compris les soufflets de dilatation
- 7 Bac à eaux usées sans bec verseur

Warranty

Cobia Boats are NMMA Certified and offer superior SeaTech “no wood” construction. All Cobias are backed by a no-nonsense, 10-year limited warranty. Cobia Boats advises owners that an authorized Cobia dealer perform maintenance and repairs on your boat. Self repairs and repairs done by a non- authorized Cobia dealer may void the warranty on the boat. The following information is general in nature and should not be considered a repair manual or

guidelines set forth by Cobia Boat Company.

Cleaning: Each Cobia Boat is constructed using the finest material and components available. However, no material is immune to the ravages of the saltwater environment. After each use, your boat should be rinsed thoroughly with fresh water. A mild detergent may also be used to remove any dirt, silt or stains. A light coat of lubricants on metal railing, screws, and electrical

connections will help prevent electrolysis. The same holds true for your trailer.



**No Matter Which Direction You're Going,
Your Boat is Always Covered.**



COBIA